



United States and Canada

2007 OWNER'S MANUAL

Escape Spa Series

Manufactured after December 1, 2006 • United States and Canada
© 2007 California Acrylic Industries, Inc.



www.calspas.com



Due to our continuous improvement programs, all models, operation, and/or specifications are subject to change without prior notice.

Read This First!

Important Safety Instructions	3
Basic Spa Information	4

Preparing for Your New Portable Spa

Planning the Best Location	5
Preparing a Good Foundation	5
Electrical Set-up Before Delivery of Your Spa	6
240 Volt Electrical Installation	6
Filling and Powering Up Your Portable Spa	7

Operating Your Spa

Electronic Control Operation	9
Adjustable Jets	12
Waterfalls	12
Diverter Knobs	12
Air Venturis	12
Multi-Colored Spa Light Operation	12

Water Quality Maintenance

Cal Spas Clear Water Plan	13
Before You Begin	13
Chemical Safety	14
Chemical Descriptions	15
Traditional Chemical Start Up	17
Bromine Clear Water Plan	17
Chlorine Clear Water Plan	18
Ozonator Clear Water Plan	18
Clear Water Maintenance	19

Cleaning and Maintenance

Cleaning and Replacing the Filter	20
Cleaning the Cover, Shell and Pillows	20
Draining Your Portable Spa	22
Removing and Reseating the Pillows	23
Winterizing (Cold Climate Draining)	23
Spa Cover	24

Using the Cal Entertainment System™

Operating the CD Player	25
Wired Remote Control	25
Raising and Lowering the 20" TV	26
Playing a Movie	26
Using the Universal Remote Control	26
Programming the Universal Remote Control	27

Appendix

Replacement Parts	28
Keeping Fit with your Cal Spa	31
Cal Spas™ Chemicals	33
2007 Warranty Information	34



Copyright 2006-2007 California Acrylic Industries, Inc. All rights reserved. Duplication without written consent is strictly prohibited.

Cal Spas™, Adjustable Therapy System™, ATS™, Bio-Clean™, Cal Balance™, Cal Entertainment System™, Cal Zone Quest 1000™ and Cal Zone Quest 2000™, Cal Sweep™, Cal Select™, Fitness Spa Series™, Spa Cal™, and XL Heat Exchanger™ are registered trademarks.

Due to continuous improvement programs, all models, operation, and/or specifications are subject to change without prior notice.

LTR20071040, Rev. A
8/1/07

CONTACT INFORMATION

For customer service, please contact your authorized dealer immediately. If you need additional information and/or assistance, please contact:

C.A.I. Customer Service Department
1462 East Ninth Street
Pomona, CA 91766.

Toll Free: 1-800-CAL-SPAS
Fax: 1-909-629-3890

Read This First!

Important Safety Instructions

When installing and using this electrical equipment, always follow basic safety precautions. Following these instructions will help make your first spa session a pleasurable one.

READ AND FOLLOW ALL INSTRUCTIONS

All 120V spas require a DEDICATED 20 AMP GFCI SERVICE. Do not use extension cords.

NOTE: A licensed electrician may be required to upgrade your standard receptacle and/or circuit breaker.

All 240V spas require a DEDICATED 50 AMP GFCI SERVICE WITH FOUR #6 AWG COPPER WIRES.

DANGER -- RISK OF ACCIDENTAL DROWNING: Do not allow children to be in or around a spa unless a responsible adult supervises them. Keep the spa cover on and locked when not in use. See instructions enclosed with your cover for locking procedures.

DANGER -- RISK OF INJURY: The suction fittings in this spa are sized to match the specific water flow created by the pump. Should the need arise to replace the suction fittings, or the pump, be sure the flow rates are compatible.

DANGER -- RISK OF INJURY: Never operate the spa if the suction fitting or filter baskets are broken or missing.

DANGER -- RISK OF INJURY: Never replace a suction fitting with one that is rated less than the flow rate marked on the original suction fitting.

DANGER -- RISK OF ELECTRIC SHOCK: Install the spa at least 5 feet (1.5 meters) from all metal surfaces. As an alternative, a spa may be installed within 5 feet of metal surfaces if each metal surface is permanently bonded by a minimum #8 AWG solid copper conductor to the outside of the spa's control box.

DANGER -- RISK OF ELECTRIC SHOCK: Do not permit any external electrical appliances, such as lights, telephones, radios, televisions, and etc., within 5 feet (1.5 meters) of the spa. Never attempt to operate any electrical device from inside the spa. This does not apply to lights, stereos and televisions that are built in to the spa as factory options from Cal Spas™.

WARNING -- RISK OF INJURY

- The spa water should never exceed 104°F (40°C). Water temperatures between 100°F (38°C) and 104°F (40°C) are considered safe for a healthy adult. Lower water temperatures are recommended for young children and when spa use exceeds 10 minutes.
- High water temperatures have a high potential for causing fetal damage during pregnancy. Women who are pregnant, or who think they are pregnant, should always check with their physician prior to spa usage.
- The use of alcohol, drugs or medication before or during spa use may lead to unconsciousness, with the possibility of drowning.
- Persons suffering from obesity, a medical history of heart disease, low or high blood pressure, circulatory system problems or diabetes should consult a physician before using the spa.
- Persons using medications should consult a physician before using the spa since some medications may induce drowsiness while others may affect heart rate, blood pressure and circulation.

Hyperthermia Danger

Prolonged exposure to hot air or water can induce hyperthermia. Hyperthermia occurs when the internal temperature of the body reaches a level 3°F to 6°F above the normal body temperature of 98.6°F (or 2°C to 4°C above 37°C). While hyperthermia has many health benefits, it is important not to allow your body's core temperature to rise above 103°F (39.5°C). Symptoms of excessive hyperthermia include dizziness, lethargy, drowsiness and fainting. The effects of excessive hyperthermia may include:

- Failure to perceive heat
- Failure to recognize the need to exit spa or hot tub
- Unawareness of impending hazard
- Fetal damage in pregnant women
- Physical inability to exit the spa
- Unconsciousness

WARNING: The use of alcohol, drugs, or medication can greatly increase the risk of fatal hyperthermia.

Read This First!

Basic Spa Information

The following operating and maintenance instructions are very important and must be followed carefully. With the proper care and maintenance, your Cal Spa will provide you with years of satisfaction and performance.

Do not be afraid to push buttons or turn knobs to learn about your new Cal Spa, as it is built with quality materials and excellent craftsmanship.

Your new Cal Spa has been engineered with a high-powered water pump that pushes water through various therapy jets, which will relax even the tightest muscles. In addition to the water pressure, you can add air into the spa water with air venturi handles located seat-side that increase the intensity of your massage.

The filtering of this spa is very important. It will minimize cleaning time and the amount of chemicals needed to keep your spa water balanced. The two daily pre-programmed filter cycles of two hours in duration can be increased to six hour cycles if the need arises. This can be accomplished through the topside control panel.

IMPORTANT: Keep the spa covered when not in use!

- Covered spas use less electricity while maintaining a set temperature.
- Covering your spa will protect your spa's finish from the sun's ultraviolet rays.
- You are required to keep the spa covered to maintain warranty coverage.
- Covering your spa helps prevent children from drowning in the spa.

Your new Cal Spa comes equipped with an electric heater. Following the directions listed below will ensure the most efficient operation:

NOTE: This method is only for spa usage under two hours a week.

- Keep the spa's operating temperature 5°F below the desired usage temperature when not in use. One or two hours before use, set the temperature to the desired temperature.
- If the spa usage exceeds two hours a week, the set temperature should remain at the desired usage temperature.
- The air venturis should be used sparingly. When open, water temperature drops quite rapidly and can also dissipate chemicals.

Allowing the water temperature to lower more than 10°F below the desired usage temperature and reheating it prior to usage will cause the heater to operate longer than it normally would maintaining the desired temperature. Doing this will increase your operating cost and makes your heater work more than necessary.

The filter needs to be cleaned or changed on a regular basis. This process takes only a few minutes and the result is increased water clarity and equipment longevity.

Water level is very important to the operation of your spa. If the water level is too low or too high, your spa will not operate properly. The water level should be to the middle of the skimmer area when the spa is not being used.

We recommend that your spa water be changed every 4 to 6 months. You may find the need to change your spa water more frequently with heavy use. When empty, your spa should be cleaned with a non-abrasive cleaner, such as Cal Spas™ All Surface Cleaner, and then rinsed thoroughly.

See the section "Cleaning and Maintaining Your Spa" for instructions on draining your spa.

When filling your spa, always fill through the skimmer filter canister. Use only regular tap water.

WARNING: DO NOT USE SOFT WATER.

Preparing for Your New Portable Spa

Most cities and counties require permits for exterior construction and electrical circuits. In addition, some communities have codes requiring residential barriers such as fencing and/or self-closing gates on property to prevent unsupervised access to the property by children. Your dealer can provide information on which permits may be required and how to obtain them prior to the delivery of your Cal Spa™.

Planning the Best Location

Here are some of the things that you will need to consider when determining where to place your new spa.

Safety First

Do not place your spa within 10 feet (3 m) of overhead power lines.

Consider How You Will Use Your Spa

How you intend to use your spa will help you determine where you should position it. For example, will you use your spa for recreational or therapeutic purposes? If your spa is mainly used for family recreation, be sure to leave plenty of room around it for activity. If you will use it for relaxation and therapy, you'll probably want to create a specific mood around it.

Plan for Your Environment

If you live in a region where it snows in the winter or rains frequently, place the spa near a house entry. By doing this, you will have a place to change clothes and not be uncomfortable.

Consider Your Privacy

In a cold-weather climate, bare trees won't provide much privacy. Think of your spa's surroundings during all seasons to determine your best privacy options. Consider the view of your neighbors as well when you plan the location of your spa.

Provide A View With Your Spa

Think about the direction you will be facing when sitting in your spa. Do you have a special landscaped area in your yard that you find enjoyable? Perhaps there is an area that catches a soothing breeze during the day or a lovely sunset in the evening.

Keep Your Spa Clean

In planning your spa's location, consider a location where the path to and from the house can be kept clean and free of debris.

Prevent dirt and contaminants from being tracked into your spa by placing a foot mat at the spa's entrance where the bathers can clean their feet before entering your spa.

Allow For Service Access

Many people choose to install a decorative structure around their spa. If you are installing your spa with any type of structure on the outside, such as a gazebo, remember to allow access for service. It is always best to design special installations so that the spa can still be moved, or lifted off the ground.

Preparing a Good Foundation

Your spa needs a solid and level foundation. The area that it sits on must be able to support the weight of the spa and the occupants who use it. If the foundation is inadequate, it may shift or settle after the spa is in place, causing stress that could damage your spa shell or finish.

Damage caused by inadequate or improper foundation support is not covered by the warranty. It is the responsibility of the spa owner to provide a proper foundation for the spa. We strongly recommend that you have a qualified, licensed contractor prepare the foundation for your spa.

Place the spa on a level foundation (preferably a 4" concrete slab). If you are installing the spa indoors, pay close attention to the flooring beneath it. Choose flooring that will not be damaged or stained.

If you are installing your spa on an elevated wood deck or other structure, consult a structural engineer or a contractor to ensure the structure will support the weight of 150 pounds per square foot.

Your Cal Spas™ retailer can help you with your foundation and more. Your retailer has a wealth of information and experience about how to get the most out of your spa and can provide you with a full line of accessories that are designed to compliment your spa and increase your enjoyment.

Preparing for Your New Portable Spa

Electrical Set-up Before Delivery of Your Spa

When installed in the United States, the electrical wiring of this spa must meet the requirements of National Electric Code, ANSI/NFPA 70-1999 and any applicable state or local codes. The electrical circuit must be installed by an electrical contractor and approved by a local building / electrical inspector.

All 240V spas must be permanently connected (hard wired) to the power supply. 120V spas may use a GFCI cord, plugged into a dedicated grounded outlet. Supplying power to a spa that is not in accordance with these instructions will void both the independent testing agency listing and the manufacturer's warranty.

The power supplied to the spa must be on a dedicated GFCI protected circuit with no other appliances or lights sharing the power.

To determine the current, voltage, and wire size required for the spa configuration to be connected, refer to the following:

- Wire size must comply with NEC and/or local codes.
- Wire size is determined by length of run from breaker box to spa and maximum current draw.
- We recommend copper wire with THHN insulation.
- All wiring must be copper to ensure adequate connections. Do not use aluminum wire.
- When NEC requires the use of wires larger than #6 (10mm²), install a junction box near the spa and use #6 (10mm²) wire between the junction box and the spa.

IMPORTANT: A clearly labeled emergency shutoff or control switch for the purpose of disconnecting all electrical power to the spa including the motors, recirculation system and jet system shall be installed at a point readily accessible to the users and not less than 5 feet (1.5 m) away, adjacent to, and within sight of the spa. (NEC 680.41)

The electrical circuit for the spa must include a suitable GFCI as required by NEC 680.31.

240 Volt Electrical Installation

All 240V spas must be permanently connected (hard wired) to the power supply. These instructions describe the only acceptable electrical wiring procedure. Spas wired in any other way will void your warranty and may result in serious injury.

These are the only acceptable electrical wiring procedures. Spas wired in any other way will void your warranty. See the wiring diagrams on the following pages

When installed in the United States, the electrical wiring of this spa must meet the requirements of National Electric Code, ANSI/NFPA 70-2005 and any applicable local, state, and federal codes. The electrical circuit must be installed by an electrical contractor and approved by a local building / electrical inspector.

GFCI and Wiring Requirements

The power supplied to the spa must be on a dedicated GFCI protected circuit as required by NEC 680.31 with no other appliances or lights sharing the power.

All 240V spas require one 50 amp GFCI with four #8 AWG copper wires. Ultimate Fitness spas with the optional 5.5kW auxiliary heater require a second dedicated electrical service with one 30 amp GFCI and three #8 AWG copper wires.

Use copper wire with THHN insulation. Do not use aluminum wire. When NEC requires the use of wires larger than #6 AWG, install a junction box near the spa and use #6 AWG wire between the junction box and the spa.

Wire runs over 85 feet must increase wire gauge to the next lower number. For example: A normal 50 amp GFCI with four # 6 AWG Copper wires run over 85 feet would require you to go to four # 4 AWG copper wires.

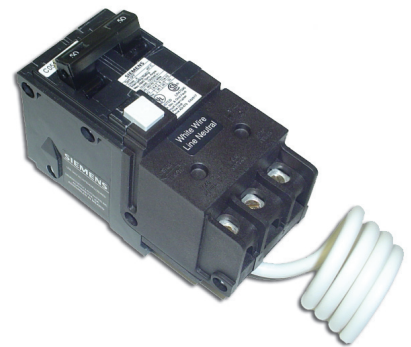

Preparing for Your New Portable Spa

Testing the GFCI Breaker

Test the GFCI breaker prior to first use and periodically when the spa is powered. To test the GFCI breaker follow these instructions (spa should be operating):

1. Press the TEST button on the GFCI. The GFCI will trip and the spa will shut off.
2. Reset the GFCI breaker by switching the breaker to the full OFF position, wait a moment, then turn the breaker back on. The spa should have power again.

Filling and Powering Up Your Portable Spa

Never fill your spa with soft water. Soft water makes it impossible to maintain the proper water chemistry and may cause the water to foam, which will ultimately harm the finish of the spa and void your warranty.

1. Once the spa has been placed on an approved surface and has been correctly wired by a licensed electrician, inspect all plumbing connections in the equipment area of your spa. Ensure that these connections are secure and that they did not loosen during shipment.
2. If equipped, open all gate valves in the equipment area. Before operating the spa, these valves must be in the up or "open" position.
3. Remove the filter basket and cartridge from skimmer/filter canister.
4. Place a garden hose in the skimmer/filter canister and fill your spa with regular tap water to the proper water level (halfway up the skimmer area).

5. (For owners of the automatic bromine generator) Make sure the dial on the face of the bromine generator unit is turned to the "OFF" position.
6. Open the air relief valve (located next to the two filters, if equipped) after the air bubbles stop coming out of it. Close the valve hand-tight.
7. Once the water is at the correct level and air is bled, turn on the power at the GFCI breaker. (Ensure that the 120V spas are connected to the proper electrical outlet.)

Depending on the model, when the power is turned on to the spa, the controls will perform a diagnostic check for approximately five minutes. When the diagnostic is complete, the spa will automatically operate at filter speed and continue heating until the spa water temperature reaches the default temperature of 100°F.

8. If no water is flowing when the pump is running there could be an air pocket at the suction side of the pump. Shut off power to the spa and loosen the pump union on the suction side of the pump to bleed the air. When air is bled, turn power back on.
9. Re-install the filter and the filter basket into the skimmer/filter canister.

The spa is now ready for use.

NOTE: Never run the spa with the gate valves closed or without water circulating for long periods of time. Be careful not to over-tighten the plumbing fittings.

Preparing for Your New Portable Spa

GFCI Hook-Up

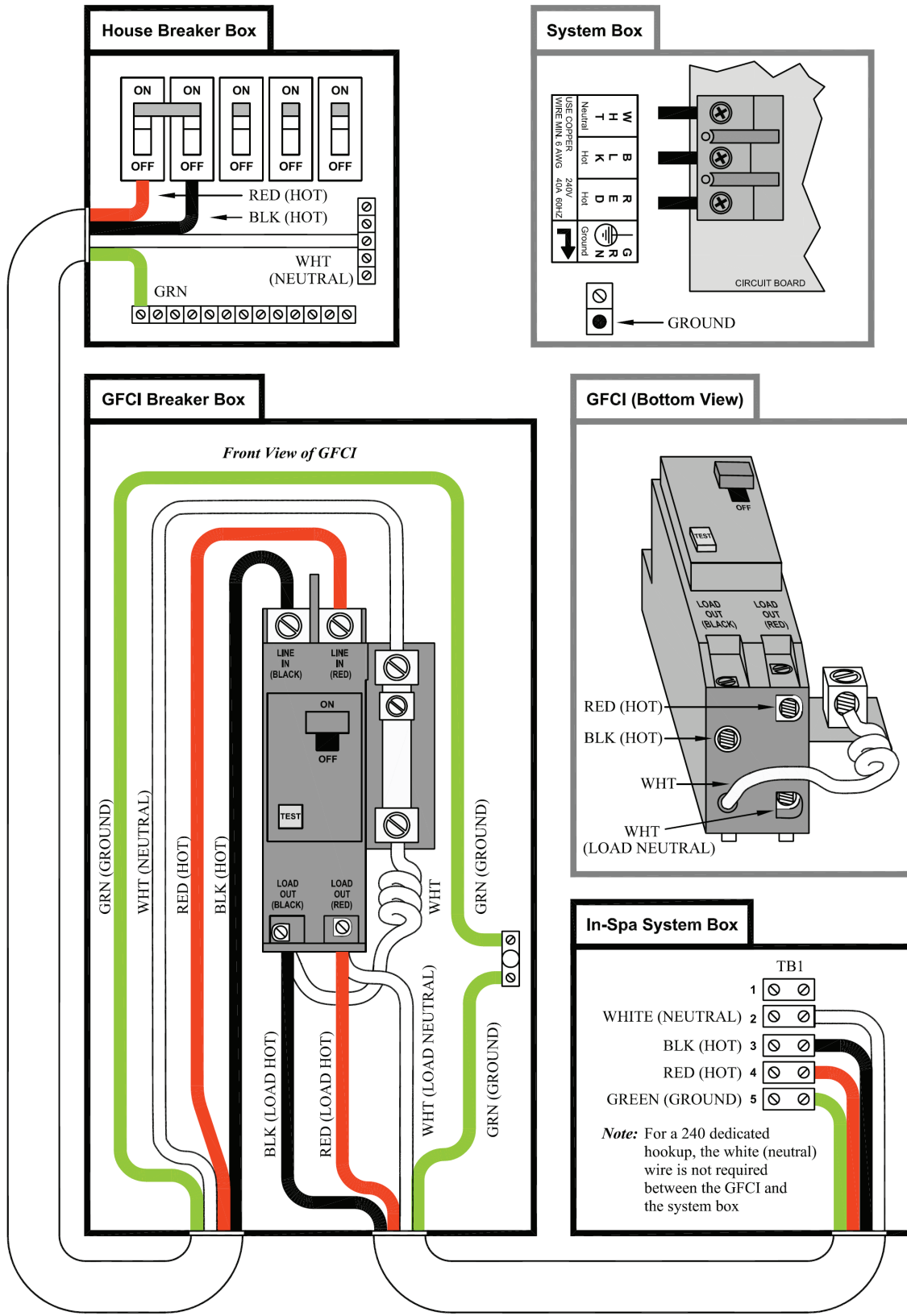

Operating Your Spa

Electronic Control Operation

Initial Start up

When first powered up, it will automatically revert to Priming mode. **Pr** on the topside display will indicate this. Priming mode will be active for less than five minutes at which time the heater will be activated and the water temperature will be maintained in Standard mode. The spa will heat to 100°F (37°C) at start up until the set temperature is changed as described below.

Temperature Adjustment

(Range 80°F to 104°F, 26°C to 40°C)

The electronic control panel displays the actual water temperature in degrees Fahrenheit. The displayed temperature will only be current after the pump has been running for at least two minutes.

To display the temperature that the spa is set to:

- Press the **Temp** button. The temperature setting will flash.
- While the display is flashing, each time you press **Temp** button, the set temperature will change up or down one degree.
- If the desired temperature is opposite of the direction each press of the button is making, release button, allow display to stop flashing and then press **Temp** button to change temperature the other direction.

Standard, Economy and Sleep Heating Modes

Your new spa is equipped with a heating feature that gives you complete control of the heating system. When the spa is powered up, it will automatically start in standard heating mode.

- **St** will light briefly on the main display. In this mode, the heating system will automatically maintain the set spa temperature. In the economy-heating mode, the heating system will only activate during filtration times.
- **Ec** will display solid if temperature is not current and will alternate with spa temperature if measured temperature is current.
- Economy mode will heat the water to the set temperature while Sleep mode, indicated by a **SL** on the main display, will also only activate



the heater during the filtering cycles but will only heat the water to within 20°F (10°C) of the set temperature. Like Economy mode, **SL** will display solid when temperature is not current and will alternate with actual temperature when it is current.

NOTE: Displayed temperature will only be current after the pump has been running for at least two minutes.

Switching Modes

- Press **Temp** button followed by the **Light** button.
- Press the same sequence to switch to the next mode.

Pump Operation

Press the **Jets 1** button to turn on the Pump 1 on. Press it once again to turn off the Pump 1 off.

Press the **Jets 2** button to turn on the Pump 2 on. Press it once again to turn off the Pump 2 off.

Light

Press the **Light** button to turn on the light. Press it once again to turn the light off. All optional lighting such as the control panel light and cabinet perimeter lighting is controlled by the **Light** button and will turn on and off with the spa light.

Automatic Time outs

These features will automatically turn themselves off during periods of continuous use:

- Low speed pump After 4 hours
- High speed pumps After 15 minutes
- Optional circulation pump After 15 minutes
- Optional turbo After 15 minutes
- Spa light After 15 minutes

Operating Your Spa

Setting Filtration Cycles

Your spa is programmed to filter twice a day. The first cycle will begin 6 minutes after the spa is turned on and the second cycle 12 hours later. The factory has programmed the cycle to last for 2 hours but this can be switched to 4, 6, or 8 hours depending on your requirements.

To set filtration time,

- Turn off the power to the spa at the time of day you would like one of the filtration cycles to begin then turn back on after 30 seconds.
- When power has been restored, press the **Temp** button then the **Jets** button.
- Press **Temp** button again to change the filtering cycle duration.
- When desired duration is selected press the **Jets** button to exit.

At the beginning of each filtering cycle the Turbo system will run for approximately 30 seconds. The low speed pump will run for the duration of the filtering cycle and if an Ozone system is installed it will be activated. During filtering, **FC** will appear on the main display.

Diagnostic Messages

Message	Meaning
--	Spa temperature is unknown. After pump has been running for 2 minutes temperature will be displayed.
HH	Overheat protection (spa is shutdown) DO NOT ENTER THE WATER! One sensor has detected 118°F (48°C) at the heater. Remove the spa cover and allow spa to cool below 107°F (42°C). Press any button on the topside display to reset spa. If spa will not reset after spa has cooled, turn off power for approximately 30 seconds and then turn power back on. If display message is repeated then shut the power off to the spa and call your dealer or service organization.
OH	Overheat protection (spa is shutdown) DO NOT ENTER THE WATER! If the spa has reached 110°F (43°C), remove the spa cover to cool the water. At 107°F (42°C), the spa should reset itself. If the spa does not reset, then shut the power off to the spa, wait 30 seconds and restore power to spa. If display message is repeated then shut the power off to the spa and call your dealer or service organization.
IC	A possible ice condition exists within the spa. No action is required, the pump will automatically activate.
SA or Sb	Spa is shut down. Spa has detected that one of the sensors is not operating properly. One of these may display briefly during overheat then disappear when overheat situation has been resolved. Call your dealer or service organization if message does not go away.
Sn	Sensor (Spa is shut down). The high limit or water temperature sensors are not working correctly. Call your dealer or service organization.
HL	A difference in readings between temperature sensors has been detected indicating a possible water flow problem. Make sure spa is filled to proper level and that pumps are primed (water is flowing). Also check to make sure filter cartridges are clean. If message does not reset, call your dealer or service organization.
LF	This will display on the 5th occurrence of the "HL" message in 24 hours indicating a persistent flow problem. The heater will be shut down but other functions will continue to operate. Follow "HL" message actions then press any button to reset.
dr	Insufficient water flow through the heater has been detected. Spa will be shut down for 15 minutes. Check water level and fill spa if water level is low. Make sure pumps are primed (water is flowing) and filter cartridges are clean. Press any button to reset or wait 15 minutes and spa will automatically reset. If message does not reset, call your dealer or service organization.
dY	Insufficient water level detected in heater. This will display on the 3rd occurrence of "dr" message. Follow directions for "dr" message and press any button to reset spa. Spa will not automatically reset when "dY" is displayed.
Sf	Safety Suction System (Spa is shut down). The display will show "Sf" as soon as the vacuum switch closes. All functions will turn off and the system will be disabled until a panel button is pressed.
ST	Indicates heater is in standard mode
Ec	Indicates heater is in economy mode
SL	Indicates heater is in sleep mode

Operating Your Spa

Adjustable Jets

Almost all of the jets in your spa are adjustable. Rotating the face of an adjustable jet to the left (counter-clockwise) will decrease the amount of water flow through the jet. Rotating the face of an adjustable jet to the right (clockwise) will increase the amount of water flow through the jet. (See example shown below.)

Neck jets adjust in the opposite directions (counter-clockwise to increase, clockwise to decrease).



Waterfalls

Some spa series include optional waterfalls. When the booster pump is on, turn the knob near the waterfall. Water will immediately start flowing through it.

Diverter Knobs

Diverter knobs are 1" and 2" knobs located around the top of your spa. They allow you to divert water through jets from one side of the spa to the other, or in most cases from floor jets to wall jets. This is accomplished by rotating the diverter knob to the left (counterclockwise), decreasing the amount of water flow through a section of jets. To increase the amount of water flow through the other section of jets, rotate the handle to the right (clockwise).



Air Venturis

Air venturis are the 1" knobs located around the top of your spa. They can also be distinguished from diverter knobs by the arrows and the words "OFF", "ON" and "AIR" marked on them. Each one will let you add a mixture of air with the jet pressure. This is accomplished by rotating the air venturi knob to the left (counter-clockwise) to increase the amount of airflow through the jets. To decrease the amount of airflow through the jets, rotate the handle to the right (clockwise).



Multi-Colored Spa Light Operation

Operating the Multi-Colored Spa Light

1. Turn the spa light on by pressing the "LIGHT" button on the topside control panel.
2. To filter through the different color choices, press the button on and off. Each time you press the button, you advance to the next color.
3. To turn the spa light off when not in use, press the "LIGHT" button.

Water Quality Maintenance

Cal Spas Clear Water Plan

Great spa water is easily achieved when the right chemicals and / or systems are used and the Cal Spas “Clear Water Plan” is implemented. The key to clean, clear, and safe water is to fully understand how spa water reacts to users, system operation and chemical use. The “Clear Water Plan” will help give you that understanding.

The first thing to understand about taking care of your spa water is that preventive actions are much easier to do than correcting water quality issues. For this reason, we offer the “Clear Water Plan” as a simple, easy to follow guide to clean, safe spa water.

Follow the Right Plan

You will need to decide which chemical plan or alternative sanitation option works best for your spa water. Consult your Cal Spas dealer for the right decision with regards to your lifestyle and spa usage. Whichever plan you decide on, follow it completely and don't take shortcuts. These plans will provide you with clean, safe, clear spa water with a minimum of effort.

Traditional Chemical Options

Choose from either Bromine tablets or Chlorinating granules as your sanitizer of choice. Both work well when the appropriate “Clear Water Plan” is followed. Make sure you follow all instructions and use only Cal Spas brand chemicals.

Ozonator

This system automatically generates ozone gas and injects it into the spa water. Ozone gas is far superior to chemical bromine or chlorine in sanitizing spa water. Saves replacement chemical cost and guards against forgetting to add chemicals.

Before You Begin

Before you begin a “Clear Water Plan”, you should understand that chemicals or systems alone will not take care of your spa water. Other factors such as Filtration and Bather Load also play an important part.

Filtration

The filter is the part of your spa that removes the debris from the water. Even though Cal Spas uses the advanced Bio Clean filter cartridge that protects itself

from bacterial growth, the filter still needs to be cleaned on a regular basis to maximize your spa's filtering performance and heating efficiency.

In addition to spraying off the filter weekly to remove surface debris, your filter should be deep cleaned periodically to dissolve scale and other contaminants that get lodged deep within the filter fibers and impede the filtration process. Even if the filter looks clean, the contaminants can clog the fibers and prevent water from flowing through the filter resulting in the most common spa problem—no heat, caused by a dirty filter.

Filter Cleaning

- Place the dirty filter into a bucket of water deep enough to cover the filter. Add 8oz of Cal Spas “Liquid Filter Cleaner” to the bucket of water.

Note: It is a good idea to keep a spare filter to be deep cleaned while the regular filter is in the spa. This way, you can rotate the filters and both will last longer.

- Soak the filter for a minimum of 24 hours.
- Remove the filter and spray clean with a water hose. Spray each pleat carefully.
- Allow filter to dry completely (a minimum of 2 days drying time is recommended).
- Reinstall filter as described in the “Clear Water Plan”.

Filtration Cycles

The filtration cycle of your spa is the process that allows the water to flow through the filter. Your spa will filter automatically twice each day. The factory set default time for filtration is usually enough for normal use, however heavy bather load or frequent use may require longer filtration times or more frequent filtration cycles to keep the spa water clean. Consult your Owner's Manual for setting your spa's filtration times.

Bather Load

“Bather Load” is the term used to describe the number of people using a spa, combined with the length of usage, and the frequency of usage. All these factors have a great effect on the spa water. The higher the bather load, the more chemicals need to be added and a longer filtration time will be needed.

All versions of the Cal Spas “Clear Water Plan” are designed for spas with average bather load. (3-4 people, 15 minutes of usage, 3 times a week at 100 degrees) If your bather load exceeds these guidelines, and you experience water quality problems, increase the amount of filtration first, (go to the next higher

Water Quality Maintenance

filtration number) then if water quality is still not adequate, consult the advise of your Cal Spas dealer for additional chemical or system recommendations. Be sure to give them your bather load information.

Chemical Overview

The following information is intended for use with Cal Spas chemicals only. Other brands of chemicals may have similar names and/or usage descriptions but due to manufacturing differences, use of other chemicals can increase the likelihood of under or over-dosing the spa chemicals. Damage to the spa or spa's components from improper chemicals or chemical usage is not covered under the spa's warranty.

Chemical Safety

- Failure to follow chemical directions may result in serious injury, sickness, or even death.
- Read and follow all printed instructions listed on bottles, packages and in your owner's manual.
- Do not exceed chemical dosages as recommended in the "Clear Water Plan", or on chemical bottles and packages. (Most chemical instructions are figured for a 500 gallon spa however, most spas hold less than 500 gallons, consult your Owner's Manual for the approximate gallons of your spa)
- Never mix chemicals together.
- Never change chemical brands or types without completely draining, flushing and thoroughly cleaning the spa and cover first.
- Always protect your eyes while introducing chemicals into the spa. Wear protective eyeglasses to prevent powdered chemicals from blowing into the eyes or liquid chemicals from splashing into the eyes.

- In the event of overdosing a sanitizing chemical (chlorine or bromine), immediately turn off the power to the spa and drain water to a safe and approved area. Refill with fresh water and proceed with the "Clear Water Plan" start up.

Physical Chemical Hazards

- Do not allow chemicals to come in contact with skin, eyes or clothing.
- Always wear rubber gloves, protective eye wear and clothing to reduce the risk of chemical contact and irritation.
- Remove and wash clothing that may have been exposed to chemical contact prior to wearing them again.
- Inhaling or ingesting chemicals will cause serious injury, sickness, or even death.
- Do not mix chemicals. Mixing chemicals together can cause dangerous chemical reactions including the release of toxic gas, fire and explosions.

Chemical Storage

Chemicals must be stored completely out of the reach of children in an area that is well vented, cool, and dry. Failure to provide a proper area for chemical storage may result in serious injury, sickness, fire explosion and even death. Do not store your chemicals inside the equipment area of your spa.

Chemical Descriptions

The following descriptions and recommendations are intended for use with Cal Spas chemicals only. Many of these chemicals will be used with alternative sanitation systems as well.

Test Strips -- Bromine



Provides accurate spa water testing for Bromine, pH, and total Alkalinity.

For use with bromine "Clear Water Plan".

Chlorinating Granules



Quick acting sanitizer / disinfectant for spa water.

For use with chlorine "Clear Water Plan".

Test Strips -- Sodium Bromide



Provides accurate spa water testing for Sodium Bromide.

For use with Cal Clarity Automatic Bromine Generator "Clear Water Plan".

Oxidizer Shock



Destroys ammonia, organic contaminants, and odor causing wastes in spa water.

Use with any "Clear Water Plan".

Test Strips – Chlorine



Provides accurate spa water testing for Bromine, pH, and total Alkalinity.

For use with chlorine "Clear Water Plan".

Iron Out



Helps prevent metals in water from staining spa.

Use during start up.

Use with any "Clear Water Plan".

Go Brom



Establishes a bromide reserve in spa water.

Use during start up.

For use with bromine "Clear Water Plan".

Stain And Scale Defense



Helps prevent minerals from damaging spa components.

Use with any "Clear Water Plan".

Brominating Tablets



Long lasting sanitizer / disinfectant for spa water.

Add to bromine floater.

For use with bromine "Clear Water Plan".

Ph / Alkalinity Up



Raises pH and alkalinity levels in spa water.

Use with any "Clear Water Plan".

Water Quality Maintenance

Ph / Alkalinity Down



Raises pH and alkalinity levels in spa water.

Use with any "Clear Water Plan"

Filter Cartridge Cleaner



Deep cleans filter cartridge. Dissolves scale and removes imbedded organic contaminants from filter cartridge fibers.

Use with any "Clear Water Plan"

Liquid Hardness Increaser



Helps reduce foaming and corrosion by increasing hardness levels in spa water.

Use with any "Clear Water Plan".

Enzyme Formula



Biodegrades body oils, suntan lotions, and organic contaminants in spa water.

Do not on same day as adding Chlorine Granules.

Use with any "Clear Water Plan".

Spa Brite



Helps to quickly clear up cloudy spa water.

Use with any "Clear Water Plan".

Multi-Purpose Cleaner



Special formula designed to clean spa surfaces without leaving foam-causing residue.

Use with any "Clear Water Plan".

Foam Gone



Quickly breaks up existing foam on spa water.

Use with any "Clear Water Plan"

Vinyl And Leather Cleaner



Specifically designed to clean and protect spa covers and pillows from chemical and ultraviolet damage. Use with any "Clear Water Plan".

Fast Sheen



Water based, reactive, silicone polish that seals, shines, and protects spa acrylic surfaces.

Use with any "Clear Water Plan".

Cal Balance Magnetic Water Stabilizer

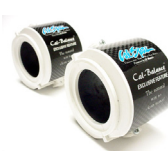

Promotes clean water naturally by organizing water molecules into appositive charge. Helps coagulate debris for improved filtration, and also traps calcium and scale into a suspension that gives spa water a soft, silky feel. Use with any "Clear Water Plan".

Traditional Chemical Start Up

Prior to filling a spa for the first time, or after a routine draining, you will want to follow this start-up plan to extend water life and performance. If you are following either the Bromine or Chlorine “Clear Water Plans”, you will notice that both start-up processes are the same with the exception of Step 7. As with all chemical dosages listed in these “Clear Water Plans”, start-up dosages are intended for 500-gallon spas. Please adjust the chemical dosages to the capacity of your particular spa.

Start Up

1. Clean surface of spa with Cal Spas “Multi-Purpose Cleaner”.
2. Apply a protective coat of Cal Spas “Fast Sheen” to the acrylic surface.
3. Fill spa to proper water level with normal tap water (Do not use soft water)
4. Use test strip and balance the spa water:
5. Adjust total alkalinity (acceptable range is 80-120ppm),
6. Then adjust pH if necessary. (between 7.2 to 7.8)
7. Pour in 16 oz of Cal Spas “Metal Protector” to center of spa.
8. Add either Bromine or Chlorine (According to your preferred plan)

Bromine: Add 2 oz of Cal Spas “Go Brom” to establish a bromine base.

Add 2 Cal Spas “Bromine Tablets” to Bromine Floater.

Set floater opening at #2.

Chlorine: Add two tablespoons of Cal Spas “Chlorine Granules” to the spa water.

9. Sprinkle 2 oz of Cal Spas “Oxidizer Shock” in the center of the spa and turn on jets for 15 minutes. Leave spa uncovered during this time.
10. Put cover on spa and allow to heat up to desired temperature.

Bromine Clear Water Plan

This plan and its chemical dosages are intended for Cal Spas chemicals only. Most chemical manufacturers use different chemical formulas and strengths. Only Cal spas chemicals are specially formulated to provide chemical balance at lower dosages. Always read and follow printed instructions on chemical bottles and packages.

Day One (Monday)

1. Test spa water using “Bromine Test Strips”.
2. Based on the Test Strip readings:
 - Adjust total alkalinity first (acceptable range of 80-120 ppm)
 - Then adjust the pH if needed. (range is between 7.2 to 7.8)
 - Add “Bromine Tablet(s)” if needed. (Do not add more than 2)
 - The recommended level of bromine is 3-5 ppm.
3. Add 2 oz of “Stain and Scale Defense”.
4. Remove dirty filter from the spa and rinse off. Allow to dry.
5. Place your extra clean filter cartridge back into the spa.
6. Vacuum debris from the bottom of your spa with the “Spa Vacuum”.

Day Two (Wednesday)

1. Test spa water using Bromine Test Strips.
2. Based on the Test Strip reading: Adjust total alkalinity, then the pH if needed.

Day Three (Friday)

1. Test spa water using Bromine Test Strips.
2. Based on the Test Strip reading:
 - Adjust total alkalinity, then the pH if needed.
 - Add one Bromine Tablet (if needed).
3. Add 2 oz of Oxidizer Shock to spa. Run Spa for 15 minutes with cover off.
4. Replace cover.

Water Quality Maintenance

Chlorine Clear Water Plan

This plan and its chemical dosages are intended for Cal Spas chemicals only. Most chemical manufacturers use different chemical formulas and strengths. Only Cal spas chemicals are specially formulated to provide chemical balance at lower dosages. Always read and follow printed instructions on chemical bottles and packages.

Day One (Monday)

1. Test spa water using "Chlorine Test Strips".
2. Based on the Test Strip readings:
 - First adjust total alkalinity (acceptable range of 80-120 ppm)
 - Then adjust the pH if needed. (range is between 7.2 to 7.8)
 - Add 2 tablespoons of Chlorine Granules.
 - The recommended level of chlorine is 3-5 ppm.
3. Add 2 oz of "Stain and Scale Defense".
4. Remove dirty filter from the spa and rinse off.

5. Place your extra clean filter cartridge back into the spa.
6. Vacuum debris from the bottom of your spa with the "Spa Vacuum".

Day Two (Wednesday)

1. Test spa water using Chlorine Test Strips.
2. Based on the Test Strip reading: Adjust total alkalinity, then the pH if needed.

Day Three (Friday)

1. Test spa water using Chlorine Test Strips.
2. Based on the Test Strip reading:
 - Adjust total alkalinity, then the pH if needed.
 - Add 2 tablespoons of Chlorine Granules. (if needed)
3. Add 2 oz of Oxidizer Shock to spa. Run spa for 15 minutes with cover off.
4. Replace cover.

Ozonator Clear Water Plan

This plan and its chemical dosages are intended for spas equipped with the optional ozonator. The chemical references are designed for Cal Spas chemicals only.

Start Up

1. Follow the Spa Start Up procedures for Chlorine "Clear Water Plan".
2. Set the spa's filtration time for "F-4". This activates the ozonator and produces the ozone gas. (Follow the instructions in the owner's manual)
3. Note: Filtration time may need to be increased with heavy bather load.

Day One (Monday)

1. Test spa water using chlorine "Test Strips". (you will need to use a small amount of chlorine as a supplemental sanitizer)
2. Based on the Test Strip readings:
 - First adjust total alkalinity (acceptable range of 80-120 ppm),
 - Then adjust the pH if needed. (range is between 7.2 to 7.8)

- Add 1 tablespoon of Chlorine Granules.
 - The recommended level of Chlorine is 1-3 ppm.
3. Add 2 oz of "Stain and Scale Defense".
 4. Remove dirty filter from the spa and rinse off.
 5. Place your extra clean filter cartridge back into the spa.
 6. Vacuum debris from the bottom of your spa with the "Spa Vacuum".

Day Two (Friday)

1. Test spa water using Chlorine Test Strips.
2. Based on the Test Strip reading:
 - Adjust total alkalinity, then the pH if needed.
 - Add 1 tablespoon of Chlorine Granules. (if needed)
3. Add 2 oz of Oxidizer Shock to spa. Run Spa for 15 minutes with cover off.
4. Replace cover.

Clear Water Maintenance

Regardless of which “Clear Water Plan” you are using, you should also do the following:

Every Month

1. Deep clean your spa’s filter. (Follow “filter cleaning” instruction at beginning of “Clear Water Plan”)
2. Check inside the equipment area for leaks, rodents, and insects.
3. If a leak is discovered, contact your Cal Spas dealer for service.
4. If you see evidence of rodents or insects, take necessary actions to remove them and precautions to prevent them from returning.

Every 3 To 4 Months

1. Drain and clean your spa with “Multi-Purpose Cleaner”.
2. Polish the acrylic surface with “Fast Sheen”.
3. Clean and treat spa cover, pillows, and Cal Select cabinet (if equipped) with “Cover Protector”.
4. When re-filling your spa, follow your specific “Clear Water Plan” Start Up procedures.

Once A Year

1. Clean and treat redwood spa cabinets and gazebos with “Nu-Spa Redwood Stain Renew and Brightener”.
2. If you use the ozonator, you will need to replace the ozone cartridge.
3. Check the filter cartridge pleats. If they are frayed, replace the cartridge.

Cleaning and Maintenance

Cleaning and Maintenance

Cleaning and Replacing the Filter

Filtration

Filtration is one of the most important steps you can take to ensure clean, clear water. Regardless of what some people may think, it is far less expensive to fix water clarity problems by filtering your spa than by using excessive amounts of chemicals, excessive filtration times, or by water replacement.

Cal Spas™ filtration system draws contaminated water through the exclusive Bio-Clean™ filter removing debris from the water. It then pumps the newly cleaned water back into the spa through various jets. Spas equipped with the optional ozonator will also receive ozone injection into the filtered water for further protection against contaminants during filtration cycles. Filtration also ensures that chemicals are mixed thoroughly through the water, increasing performance.

Filtration starts on electronically controlled spas as soon as the pumps are primed and water flow is steady. As the flow of water goes through the filter, dirt and debris is removed and accumulated in the filter cartridge. As the filter cartridge accumulates dirt and debris, water flow is restricted and jet performance is reduced. This can cause your spa to not run or heat effectively.

Clean your filter regularly and replace as needed.

Filter Cleaning

Your new Cal Spa has been designed for quick and easy filter maintenance. The filter cartridge should be cleaned once a week. These instructions apply to both dual and single filtration systems.

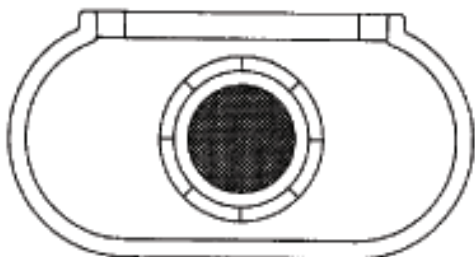

Filtration System
50 square foot system

1. Turn the power off at the breaker.
2. Remove the filter by turning it counterclockwise and unscrewing the bottom threads. Then pull it up and out.
3. Clean the filter with a garden hose as follows:
 - a. Hold the filter vertically.
 - b. Spray the filter cartridges with a pressure nozzle, starting from the top and spraying down each pleat.
 - c. Turn the filter cartridge over and repeat Step 3b.
 - d. Deep clean filter cartridge every month. Use only a Cal Spas™-approved filter-cleaning chemical.

Exclusive Bio-Clean™ Filter Cartridge

The filter cartridge is designed to remove dirt, sand, minerals, phosphates, bather waste and other solids from the spa. Unfortunately, some spa owners fail to include filter cleaning as part of their chemical maintenance plan. Filters accumulate debris and become prime areas for bacteria growth.

The Cal Spas™ exclusive Bio-Clean™ Filter is the only antibacterial filter cartridge on the market today. Having a filter cartridge that prevents bacteria growth is added protection for those times you forget to clean the filter. We recommend that you only replace your spa's filter cartridge with a Bio-Clean™ filter cartridge for ensured protection and peace of mind.

Cleaning the Cover, Shell and Pillows

Due to the constant punishment your spa cover and pillows receive, you should protect them by applying Vinyl and Leather Cleaner as part of your monthly maintenance plan. Cal Spas™ Vinyl and Leather Cleaner is specifically designed to protect spa covers and pillows from chemical and ultraviolet light damage. It accomplishes this without leaving an oily residue behind that is normally associated with common automotive vinyl protectants.

Use of Vinyl and Leather Cleaner

Cal Spas™ Vinyl and Leather Cleaner should be used sparingly. Incorrect usage may cause water clarity issues.



Spa Covers

1. Remove spa cover from spa.
2. Allow spa cover to dry completely.
3. Spray Vinyl and Leather Cleaner to cover evenly and wipe dry.
4. Allow spa cover to dry completely.
5. Reinstall cover on spa.

Pillows

1. Wipe pillows dry with a soft cloth.
2. Carefully spray Vinyl and Leather Cleaner directly onto pillow.
3. Wipe pillows dry.
4. Allow pillows to dry completely.

Warning: Do not use automotive vinyl protectants on spa covers or pillows. These products are generally oil-based and will cause severe water clarity issues that are difficult to correct.

All-Purpose Cleaner (Spa finish cleaning)



Cal Spas™ All-Purpose Cleaner is an essential part of maintaining your spa's finish. Through normal use, the spa's finish can accumulate dirt, oil, and calcium causing a rough feel and unsightly scum lines. Cal Spas™ All-Purpose Cleaner is a low detergent, non-abrasive cleaner specifically formulated to clean the spa without damaging its acrylic finish.

The most effective solution to minimize cleaning time is prevention. When the following steps are followed, the spa's finish will actually start to resist most of the elements that cause calcium build-up and make scum line clean up easier.

Prior to Spa Start-Up and Refilling

1. Spray Cal Spas™ Multi-Purpose Cleaner directly on to the spa's finish.
2. Wipe clean with a clean soft cloth.
3. Repeat on heavily calcified areas.
4. Wipe spa thoroughly with a wet sponge, rinsing often with a bucket of clean water.
5. Allow spa to dry completely.
6. Apply a coat of Cal Spas™ Fast Sheen to the spa's entire finish with a soft towel or sponge.
7. Allow Fast Sheen to dry until white and powdery.
8. Buff clean with a soft cloth, rotating frequently.

Periodic Maintenance

1. Spray Cal Spas™ Multi-Purpose Cleaner directly to the spa's finish.
2. Wipe clean with a clean soft cloth.
3. Wipe spa thoroughly with a wet sponge, rinsing often in a bucket of clean water.

Cal Spas™ Multi-Purpose Cleaner should not be sprayed directly into the spa water. Incorrect usage of this product will cause water clarity issues.

Fast Sheen (Spa finish protecting wax)



Cal Spas™ Fast Sheen is an essential part of maintaining your spa's finish. Through normal use, the spa's finish can accumulate dirt, oil, and calcium, causing a rough feel and unsightly scum lines. Cal Spas™ Fast Sheen is a non-oil based wax that is specifically formulated to protect the spa's finish from the chemicals and minerals associated with normal spa use.

The most effective solution to minimize cleaning time is prevention. When the following steps are followed, the spa's finish will actually start to resist most of the elements that cause calcium build-up and make scum line clean-up easier.

Cleaning and Maintenance

Prior to Spa Start-Up and Refilling

1. Spray Cal Spas™ Multi-Purpose Cleaner directly to the spa's finish.
2. Wipe clean with a soft cloth.
3. Repeat on heavily calcified areas.
4. Wipe spa thoroughly with a wet sponge, rinsing often in a bucket of clean water.
5. Allow the spa to dry completely.
6. Apply a coat of Cal Spas™ Fast Sheen to the spa's entire finish with a soft cloth or sponge.
7. Allow Fast Sheen to dry until white and powdery.
8. Buff clean with a soft cloth, rotating frequently.

IMPORTANT: Cal Spas™ Fast Sheen should not be used on spas full of water. Only apply to clean, cool, dry surfaces. Incorrect product usage may cause water clarity issues.

Draining Your Portable Spa

Your spa should be drained every four to six months, and refilled with fresh tap water. The following is the recommended method for draining your spa.

1. Turn off the power at the breaker.
2. Remove all filters.

If your drain valve is mounted on the side of the spa cabinet as shown at right, proceed to step 5.

If your drain valve is located inside the spa cabinet:

3. Using a Phillips screwdriver, remove the screws to the access panel and open it.
4. Locate hose ending with the 3/4 inch hose-bib fixture.
5. Hook up the female end of a garden hose to the drain fitting.
6. Place the other end of the garden hose where you would like the water to drain to.
7. Twist the hose-bib fixture counterclockwise and pull to open the drain.
8. Let spa drain completely, then remove garden hose.
9. Twist the hose-bib fixture clockwise to close it.

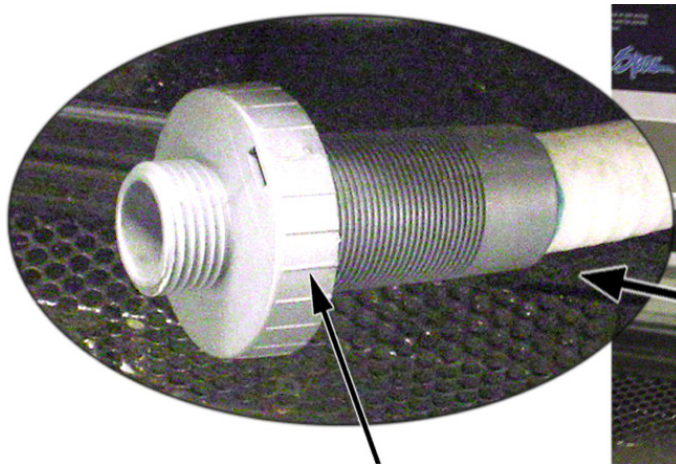

Hose-bib fixture

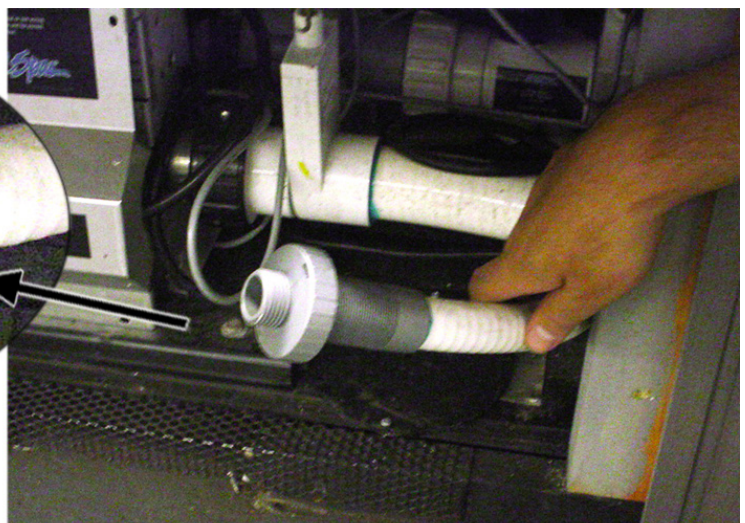

Removing and Reseating the Pillows

You can remove the pillows for cleaning and maintenance quickly and easily. This method works for all types of pillows.

Grab the lower edge of the pillow with both hands firmly and pull up. As you do this, the pillow inserts will pop out of the holes.

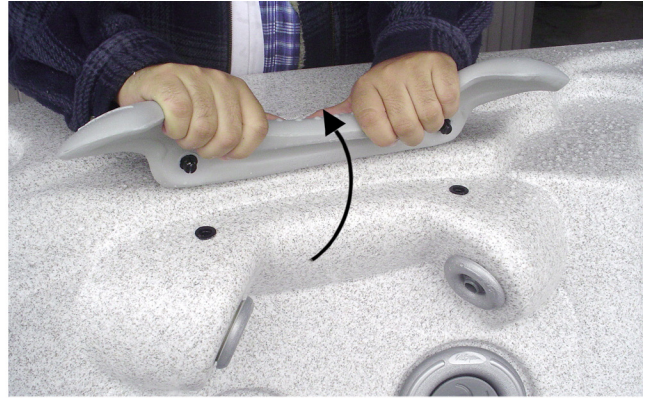

Reseat the pillows by aligning the pillow inserts with the holes and striking the pillow hard enough to insert the pegs back into the holes.



Winterizing (Cold Climate Draining)

In many areas of the country, the temperature drops below 32°F (0°C). We recommend that you always have your spa full of water and running at normal spa temperatures (80°F to 100°F, 26.7°C to 37.8°C). This will help reduce the risk of freezing in your spa and your spa's equipment.

Warning: If you find the need to drain your spa, please be aware of the potential of freezing in your spas equipment and plumbing. Even if the directions below are followed perfectly, there is no guarantee that your spa will not suffer freeze damage.

Freeze damage is not covered by your warranty.

1. Open all filter covers.
2. Remove the filter baskets and filters.
3. Drain your spa completely as described in the instructions above.

Cleaning and Maintenance

4. Remove drain plugs from the front of the pumps.
5. Disconnect the unions from both sides of the pump.
6. Use a wet/dry vacuum to blow any remaining water out of the jets and equipment area.

Cover your spa with a good spa cover and an all-weather tarp to ensure that neither rain nor snow enters the spa.

Spa Cover

Important! Keep the spa covered when not in use!

- Covered spas will use less electricity in maintaining your set temperature.
- Covering your spa will protect your spa's finish from the sun's ultraviolet rays.
- You are required to keep the spa covered to maintain warranty coverage.
- Covering your spa helps prevent children from drowning in the spa.

See the manual enclosed with your cover for instructions on mounting the locks and how to lock and unlock the cover.

In addition, while the spa cover is rigid, it is not designed to support any weight. Therefore, as a safety precaution and to preserve the life of your cover, you must not sit, stand, or lie on it; nor should you place objects of any kind on top of it.

Using the Cal Entertainment System™

Some spas may be equipped with audio/visual entertainment options. Several options are available and include marine grade CD players and DVD players. Two different TV monitors are also available. Each Cal Spa™ unit equipped with an audio/visual system is delivered with the manufacturer's operating instructions. We strongly recommend that you read these instructions prior to operating the unit.

The instructions contained in this manual describe only basic functions. See the manufacturer's operating instructions for other features and functions. These instructions are delivered with the Cal Spas™ owner's manual in a clear plastic bag.

Observe the following precautions for your entertainment system:

- Make sure that hands and CDs / DVDs are dry before coming in contact with this or any electronic option.
- Always close the CD / DVD protection door.
- Do not place wet CD's or DVD's into this unit at any time.
- Water damage is not covered by Cal Spas or the manufacturer's warranty.

Although the marine grade entertainment system is encased in a plastic housing with weather seals, the system is water resistant and NOT waterproof. You must take every precaution to keep this system dry! Water damage is not covered by Cal Spas or the manufacturer's warranty.

WARNING! Although the TV monitor is water-resistant, make sure that hands are dry before coming in contact with this or any electronic option. DO NOT SPLASH WATER ON THE TV MONITOR!

Operating the CD Player

The manufacturer's operating instructions are delivered with your spa. We strongly recommend that you read these instructions prior to operating this unit. Press the POWER button on the unit or the remote control to turn the system on. The system automatically starts in the mode it was in when it was last shut off.

Listening to the Radio

1. Press the MODE button to switch to the radio mode.

2. Press the left and right arrows located at the far right of the panel to tune the radio to a station.

Inserting a Disk

For Aquatic and Poly Planar systems:

1. Press the OPEN button on the unit. The faceplate will gently lower and expose the disk drive.
2. Insert a disk in the disk drive.
3. Flip up the faceplate.

For JBL systems, simply insert a disk into the slot in the faceplate.

Playing a CD

You can play CDs with any of the media systems (Aquatic CD, Aquatic DVD, Poly Planar, and JBL CD player).

1. Insert a disk in the disk drive as described above. The player will identify the type of disk and begin playing it.
2. Use either the remote control or the buttons on the faceplate to start and stop the player and to jump to selections.
3. To remove the disk, press the EJECT button.

Wired Remote Control

If you have an Aquatic entertainment system with the wired remote control, you can use it to adjust volume, change CD tracks, and change radio stations. If you have the optional Aquatic DVD player, you can also use the wired remote control to play, stop, pause and forward through movies.



Entertainment System

Raising and Lowering the 20" TV

Press the TV button on the auxiliary control panel to raise and lower the TV monitor. Press the button once to raise the TV. Press it again to lower the TV.

You can also press the OPT.1 button on the universal remote.

Playing a Movie

1. Press the OPT.1 button to raise the TV.
2. Turn on the TV using the universal remote control.

3. Insert a disk in the DVD player as described above. The player will identify the type of disk and begin playing it. Either the DVD menu will appear on the TV screen or the movie will begin playing automatically.
4. Use the remote control to navigate the DVD menu using the fast forward and fast reverse buttons located at the lower part of the universal remote.
5. To remove the disk, press the OPEN button on the DVD player. The faceplate will gently open. Press the small EJECT button located to the left of the disk drive slot.

Using the Universal Remote Control

Everything you want to do with your entertainment system can be controlled with the universal remote. All of the commands are organized into six areas.

Device selection buttons	Selects among six devices: TV, VCR, CD player, DVD player, stereo receiver, and satellite
Navigation and menu selection buttons	Selects among set-up, menu, and channel guide functions
Channel and volume control	Adjusts the volume up and down and
Spa controls	Selects among eight functions specific to the spa, such as blower, pumps and light
Keypad	Used to enter TV channels
CD and DVD controls	Use to control a CD or DVD player

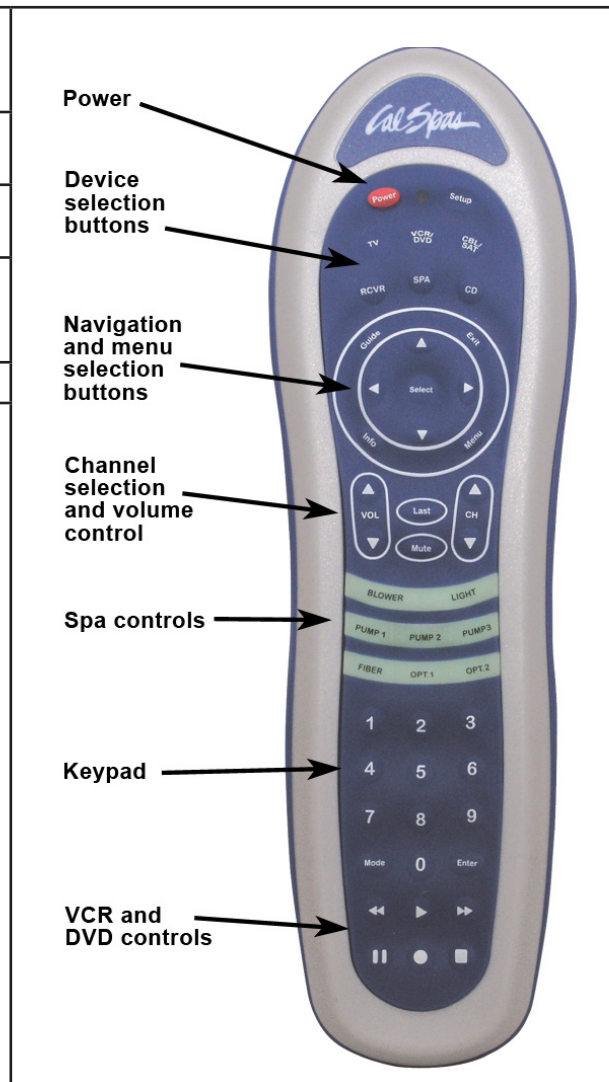

Programming the Universal Remote Control

The Cal Spas universal remote has been pre-programmed to function with the entertainment system the spa has been configured with. However, in case you need to reprogram the remote, use the device list below for the programming code.

1. Turn on the device (TV, CD player, DVD player) with the manufacturer's remote control.
2. Press the button on the remote for the device you want to program (TV, CD, DVD, etc.)
3. Press and hold the SETUP button until the LED blinks twice.
4. Enter the device code. If you perform this procedure correctly, the LED will blink twice. If not, repeat steps 2 and 3.









Device Manufacturer	Device Type	Code
Samsung 42" plasma	TV	1312
River Park 20"	TV	1530
Aquatic	CD	1867
Aquatic	DVD	1866
Poly Planar	DVD	N/A
JBL	CD	N/A

Appendix

Appendix

Replacement Parts

Jets

<p>PLU21700818 OZONE INJECTOR JET</p> 	<p>PLU21703621 (EPW) 2", INT. CLUSTER STORM, (EURO) SS W/MTL ESC</p> 	<p>PLU21703623 (SXRW) 5.5", POWER STORM JET W/SS ESC, DIRECTIONAL</p> 
<p>PLU21703629 TW 4.75", POWER SWIM JET W/SS ESC TORNADO</p> 	<p>PLU21703630 MFLW 4.25", STORM JET, MAXI FLOW W/SS ESC & DRK EYEBALL</p> 	<p>PLU21703631 (MFW) 3.25", STORM JET, MICRO FLOW W/SS ESC & DRK EYEBALL</p> 
<p>PLU21703632 (MSRW) 3" STORM JET, MICRO SWIRL W/SS ESC & DRK EYEBALL</p> 	<p>PLU21703642 (SJ) 5.5", STORM JET</p> 	<p>PLU21703643 EURO DIRECTIONAL W/SS ESC</p> 

Valves

<p>PLU21300052 DIVERTER VALVE 1" (2 WAY) SILVER, TEARDROP HANDLE (2 TONE)</p> 	<p>PLU21300062 DIVERTER VALVE 2" (2 WAY) SILVER, TEARDROP HANDLE (2 TONE)</p> 	<p>PLU21700378 VENT, 1" AIR CONTROL SILVER, TEARDROP (2 TONE)</p> 
--	--	--

Pillow

<p>ACC01400886 PILLOW, VX</p> 

Drain

<p>PLU21400132 MAIN DRAIN, SUPER HI FLO SUCTION 2" SILVER</p> 

Waterfall

<p>PLU21700730 WATERFALL SILVER W/9" SLOT CLEAR FACE</p> 
--

Weir Skimmer

<p>PLU21600270 SKIMMER WEIR GATE</p> 

Covers

ACC01200420	Standard Rust 5 to 3
ACC01200421	Standard Gray 5 to 3

Filter	FIL11100200	FILTER CARTRIDGE, 50 SQ FT. ANTI-BACTERIAL WHITE, SCREW-IN
Pump	PUM22000941	PUMP 6.0 HP 2SP 145T DBL SEAL, SWITCHLESS 2" 240V
Ozonator	OZO19001011	OZONATOR, BALBOA (CD CHIP) '07

Appendix

LED Lights

LIT16100179	CONTROLLER, SMALL, DAISY CHAIN,
LIT16100180	LED, QUAD , DAISY CHAIN,
LIT16100195	LED, DUAL , DAISY CHAIN
LIT16100201	LED CABLE HARNESS - 8' LED TO LED 4 WIRE
LIT16100202	LED CABLE HARNESS (FOR SPA LIGHT) AREA, 6 FT. 5 WIRES
LIT16100205	7 LED 2" LIGHTS, (SPA LIGHT),
LIT16100207	ROUND LED LENS,
LIT16100208	ROUND LED, SILICONE GASKET,
LIT16100153	WALLFITTING, CLEAR LENS CAP, JUMBO SPA LIGHT, 5"

Replacement Cabinet Panels

The complete selection of replacement cabinets for all model is very extensive and too lengthy for this owner's manual. See your Cal Spas deal to order replacement panels for your spa, or call 1-800-CAL-SPAS.

Keeping Fit with your Cal Spa

The fitness series spas put the fun back into fitness. This comes with everything you need for a high powered, low impact, result achieving workout in total comfort and privacy. Plus you get a spa loaded with incredible therapeutic seating, variable jet massage and generous control options, and the most gorgeous cabinetry on the planet.

The fitness equipment consists of two exercise arm bars, two exercise band cords, two exercise bands and grips, and an exercise belt. This equipment attaches quickly and easily to the exercise anchors located on the spa walls.

IMPORTANT: Always consult your physician before starting any exercise activity or program. The fitness series spas feature rubber exercise bands. When stretched, these bands create a hi-tension condition. Improper use or failure to connect the exercise bands properly may cause injury. Always inspect all of the exercise equipment prior to beginning any exercise. Do not use any damaged equipment

Fitness Series™ Exercise Program

Many people have never performed resistance training and/or may not fully understand the benefits of this extremely important form of exercise for the goal of improving your health, appearance and overall confidence.

Resistance training is necessary when trying to loose body fat, maintain and improve lean muscle structure and increase energy levels while improving flexibility.

Hydrotherapy is a remarkable way of utilizing water and heating to promote health and wellness. The majority of people are turning back to natural methods of healing and health practices to improve their body externally, but most of all internally. Hydrotherapy provides specific benefits for increased blood circulation, detoxification, reduction of body fat, replenish minerals and nutrients in the body and relieve stress.

Fitness Series™ Exercise Program

20 to 30 min. session three times a week

1. **Seated Row:** An all around exercise that focuses on the muscles of the upper back, shoulders and arms. Using the exercise bars in a seated position with your feet stable, abs tight and lower back stable. Palms down, arms extended with elbows slightly bent. Pull towards your chest squeezing your shoulder blades to the middle back and returning slowly to the starting position.
2. **Standing Chest Fly:** An excellent upper body exercise that focuses on the muscles of the chest, shoulders and arms. Using the exercise grips, place palms sideways facing your body with your elbows slightly bent. Pull forward toward your body bringing hands together, squeezing and flexing chest muscles, then slowly returning to the starting position.
3. **Standing Chest Press:** Using the exercise grips, place your palms down with your elbows bent at 90°. Press forward bringing your hands together, squeezing and flexing your chest muscles, then slowly return to the start position.
4. **Standing Shoulder Press:** Using the exercise grips, place your palms facing away from your body with your elbows bent at 90°. Press upward bringing

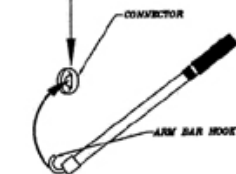
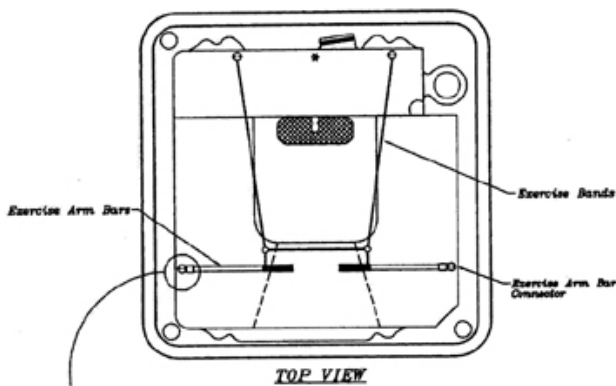

WHEN ATTACHING ARM BAR PLACE HOOD FACING AWAY FROM YOU THEN PLACE INTO THE CONNECTOR (AS SHOWN)



Appendix

your hands together in front of you, above your head and slowly return to the start position.

5. **Arm Curls:** Using the exercise grips, place your hands face up with your elbows slightly bent, pull upward towards your chin squeezing and flexing your biceps then slowly return to start position.
6. **Hydro Squats:** Excellent for defining and firming the buttocks, thighs and legs. From a standing position, slowly sink down into the water until your buttocks is level with your knees (90°). Squeezing your muscles tightly like sitting in a chair with abs tight and your back straight then slowly returning to standing position.
7. **Hydro Leg Extensions:** Sitting with your feet flat, knees bent (90°) and abs tight. Lift your foot upwards straightening the leg while squeezing and flexing the thigh muscles and slowly lowering the foot to start position.

Important: Consult your physician before starting any exercise activity or program. The fitness series spas feature rubber exercise bands. When stretched, these bands create a hi-tension condition. Improper use or failure to connect the exercise bands properly may result in injury. Always inspect all exercise equipment prior to beginning any exercise. Do not use any damaged equipment.

Warm Water Workouts

Almost any exercise that can be done on land, including walking or jogging, can be also done in water. If you have arthritis and you're exercising in a spa you will probably focus on range-of-motion exercises that work the toe, ankle, knee, leg, hip, hand, wrist and shoulder. The size and shape of the spa will determine the specific types of exercises you can do in it. Following are some low impact exercises that can assist in improving flexibility and strength.

Forward Arm Reach

With both arms, reach straight in front of you. Raise your hands overhead as high as possible, keeping your elbows as straight as you can. If one arm is very weak, use your other arm to help raise it.

Elbow Bend

Start with your elbows as straight as possible, fingers pointing down. Bend your elbows and try to touch your thumbs to your shoulders. Keep your elbows close to your body. You do not have to touch your shoulders. Then relax your elbows and straighten your arms down at your sides.

Wrist Bend

Bend both of your wrists upward and then downward. You can also exercise one wrist at a time by placing your free hand, thumb out, under the exercising wrist. Hands and fingers should be relaxed.

Finger Curl

Curl your fingers into your palm to make a loose fist then straighten them out.

Ankle Circles

While seated, make large inward circles with your left foot, moving it from the ankle. Repeat circles in the opposite direction. Then repeat the exercise with your right foot.

Spread Eagle

While sitting on the edge of a bath seat, straighten one knee. While holding it straight, slowly move it out to the side. Hold it out for three seconds, then bring it back to the center and relax. Repeat these instructions with your other leg.

Cal Spas™ Chemicals



Bromine/Chlorine Starter Kit

#CHE07000290/#CHE07000295

When used as directed, this product is effective as a spa and hot tub sanitizer/disinfectant. Treats 250 gallons for up to three weeks.



Vinyl & Leather Cleaner

#CHE07000620

Specifically designed to protect spa covers and pillows from chemical and ultraviolet damage.



Fast Sheen

#CHE07000610

Unique water-based, chemically reactive silicone sealant and polish. Seals, shines, and protects spa surfaces.



Brominating Tablets

#CHE07000760/#CHE07000770

Sanitizer, disinfectant for spas and hot tubs.



Chlorinating Granules

#CHE07000865/#CHE07000880

When used as directed, this product is effective as a spa and hot tub water disinfecting agent.



Go Brom

#CHE07000830

Establishes a bromide bank in spas and hot tubs.



Filter Cartridge Cleaner

#CHE07000690

Breaks down organic and inorganic material. Removes calcium scale and mineral deposits.



Liquid Hardness Increaser

#CHE07000250

Increases water hardness to reduce corrosion. Helps reduce foaming.



Spa Brite

#CHE07000580/#CHE07000590

Clears up cloudy water in spas and hot tubs. Effective at all spa and hot tub temperatures.



Foam Gone

#CHE07000800/#CHE07000810

Breaks up existing foam in spa water. Effective at all spa and hot tub temperatures.



pH-Alkalinity Up

#CHE07000720/#CHE07000730

Helps maintain pH in spas and hot tubs.



pH-Alkalinity Down

#CHE07000750

Lowers pH in spas and hot tubs.



Enzyme Formula

#CHE07000600/#CHE07000605

Emulsifies and biodegrades bodily oils, suntan lotion, and other contaminants in spas and hot tubs.



Metal Protector

#CHE07000630/#CHE07000640

Controls water discoloration caused by minerals. Special Extra Strength formula for spas and hot tubs.



Stain & Scale Prevention

#CHE07000650/#CHE07000660

Prevents minerals from damaging spa components and affecting performance.



Oxidizer Shock

#CHE07000680/#CHE07000710

Destroys organic contaminants and odor-causing wastes.

Appendix

2007 Warranty Information

See your Cal Spas™ dealer for a copy of the applicable warranty, details, and any questions you may have regarding the warranty coverage on your spa.

Warranty Specifics

- Five Year Cabinet Warranty: Cabinet surface peeling, blistering, or delamination is specifically excluded from this warranty.
- Five Year Freedom Seal Warranty: Leaking caused by operating pump while dry is specifically excluded from this warranty.

Warranty Limitations

The 2007 Limited Warranty is void if the spa has been subject to negligence, alteration, misuse, abuse, repairs by non-C.A.I. authorized representatives, incorrect electrical installation, acts of God and any other cases beyond the control of C.A.I. Examples of common acts invalidating this warranty include, but are not limited to:

- Use of spa in a non-residential application.
- Scratches caused by normal use.
- Operation of spas water temperature out of the normal operating range of 32°F (0°C) to 118°F (47.8°C).
- Damage caused by incorrect water level (low, overflow, etc.).
- Damage caused by extreme weather conditions (hot, cold, etc.).
- Damage caused by dirt, sand and calcium.
- Damage caused by clogged filter cartridges. See filter cleaning recommendations in this Owner's Manual.
- Damage caused by continued operation of this spa with either a known or an unknown problem.
- Damage caused by tri-chlor, acids, chlorine tablets, and any other spa chemicals not authorized by C.A.I.
- Damage caused by improper water chemistry. (High levels of chlorine, bromine, calcium, pH and other excessive chemical levels.)
- Damage caused by direct sunlight. Spas should always be covered when not in use.
- Damage caused as a result of failure to follow operating instructions as defined within this Owner's Manual.
- Damage caused by incorrect electrical installation, electrical brownout, voltage spikes, or operation of spa out of voltage range by more than ±10%.
- Spas improperly installed in-ground or placed on non-approved surfaces.

The Limited Warranty applies only to spas normally used for personal, family or household purposes.

Warranty Exclusions

Replaceable service items such as filters, light bulbs, pillows, jet inserts, spa covers, and filter covers are specifically excluded from the limited warranty.

Spa covers and stereo systems are delivered with their own manufacturer's warranty. For more info, please see their warranties in the owner's information package that was delivered with your spa for more information.

Equipment adjustments (such as pressure switch adjustments) are specifically excluded from this warranty.

2007 WARRANTY

This limited warranty is effective for portable spas manufactured after December 4, 2006.

Spa Shell / Structural Warranty



Portable Cal Spas hot tubs: C.A.I. warrants against the loss of water through the spa shell due to defects in materials and/or workmanship for a period of 10 years from the original date of purchase.

Interior Surface Warranty



Portable Cal Spas hot tubs: C.A.I. warrants against cracks, blisters, peeling, discoloration and delamination of Altair Plus / Quarite Plus interior surfaces for a period of 10 years from the original date of purchase.

Equipment Warranty



Portable Cal Spas hot tubs: C.A.I. warrants the spa's electrical and electronic components, specifically: the control system, pumps and air blowers against malfunction due to defects in materials and/or workmanship for a period of five years from the original date of purchase.

Interior Surface Warranty



Portable Cal Spas hot tubs: C.A.I. warrants against cracks, blisters, peeling, discoloration and delamination of standard acrylic/quarite interior surfaces for a period of 5 years from the original date of purchase.

Plumbing Warranty



Portable Cal Spas hot tubs: C.A.I. warrants all factory installed plumbing and Eliminator™ Plus Wet Ends from loss of water due to defects in material and/or workmanship for a period of five years from the original date of purchase.

Cabinet Warranty



C.A.I. warrants Cal Premium™, Cal Select™ and Cal Stone™ panels against cracking and warping for a period of five years from the original date of purchase.

Component Warranty



C.A.I. warrants manufacturer-installed XL Heat Exchanger™ and Cal Zone Quest 2000 Ozonator™ against malfunction due to defects in materials and/or workmanship for a period of 5 years from the original date of purchase.

Freedom Seal™



C.A.I. warrants the factory installed Freedom Seal™ for a period of 5 years against leaking.

LED Light Source



C.A.I. warrants the LED light source for a period of one year from the original date of purchase.

Extent of Warranty

This limited warranty is only valid on portable hot tubs delivered in the United States and Canada. However, it does not apply to special offers and events and extends through the selling dealer to the original purchaser at the original site of installation. This warranty becomes valid at time of purchase and ends either by specified time-frame listed above, owner-transfer, relocation, or installation of any component other than by manufacturer. The Designer series spas are excluded from this warranty.

Manufacturer Warranty

All Cal Spas hot tubs are manufactured with the highest quality appliances and are warranted to be free from defects in material and workmanship at the time of delivery. The appliance warranty is extended through the manufacturer of the product including, but not limited to: televisions, stereos, DVD players, etc.

Warranty Performance

In the event of a malfunction or defect covered under the terms of this warranty, the factory authorized selling dealer is responsible for performing all necessary repairs. To obtain service, contact the selling dealer. In the event the consumer is unable to obtain satisfactory customer service from the selling dealer, written notification must be given to the C.A.I. Customer Relations Department within 10 days of the reported failure. There will be no charge for parts or labor on a covered item. However, the C.A.I. Service Agent may assess a reasonable travel or mileage charge per service call, which may include diagnostic time. If C.A.I. determines that repair of a covered item is not feasible, C.A.I. reserves the right to replace the defective merchandise with merchandise equal in value to the original purchase price. In the event of any warranty replacement, all removal, replacement, installation and shipping costs are the responsibility of the spa owner.

Warranty Exclusions & Limitations

This warranty is void if the spa has been subject to negligence, alteration, misuse, abuse, repairs by non-C.A.I. authorized personnel, incorrect electrical installation, installation of any component other than by the manufacturer, acts of God (including, but not limited to, acts of nature and surrounding environments), and any other cases beyond the control of C.A.I. Refer to the owner's manual for further information and examples of exclusions and common acts invalidating this warranty. This warranty excludes Designer Series Spas.

Disclaimers

This limited warranty is made with the express understanding that the spa is not an essential device or medical device as defined under State and Federal Law. C.A.I. shall not be liable for loss of use of the spa or other incidental or consequential costs, expense or damages, which may include but are not limited to removal of permanent deck or other custom fixtures or the necessity for crane removal. Any implied warranty shall have duration equal of the applicable warranty stated above. Under no circumstances shall C.A.I. or any of its representatives be held liable for injury to any person or damage to any property, however arising.

Legal Remedies

This limited warranty gives you specific legal rights and you may have other rights, which may vary from state to state.

Customer Service

For customer service, contact the authorized selling dealer immediately. If you need additional information or assistance, please contact the C.A.I. Customer Relations Department at 1462 E. Ninth St., Pomona CA 91766 or call (800) 225-7727.



Locating the product serial number

The serial number of your Cal Spa is located on a metal plate attached to the lower right front panel of the spa. You will need this number to properly register your grill or cart and activate coverage. Write this information in the space provided below.

Cal Spa Model: _____

Cal Spa Serial Number: _____

Date Purchased: _____

Date Installed: _____

Cal Spa Dealer's Phone Number: _____

Cal Spa Dealer's Address: _____

CONTACT INFORMATION

For customer service, please contact your authorized dealer immediately. If you need additional information and/or assistance, please contact:

C.A.I. Customer Service Department
1462 East Ninth Street
Pomona, CA 91766.

Toll Free: 1-800-CAL-SPAS
Fax: 1-909-629-3890

www.calspas.com