

# Escape Series

2  
0  
2  
4



**Cal Spas**

 **Made in USA**

**UL** US  
**LISTED**



**Cal Spas Home Resorts™**

**Owner's Manual**



Congratulations! You are now the owner of the finest spa built. Now you will experience true comfort and relaxation as you never had before. We at Cal Spas® focus on quality, design and comfort in order to create a truly luxurious experience like no other.

Welcome to the Cal Spas® family.

It is important that you register your Cal Spas product as soon as possible. By taking just a few quick minutes to register, you can enjoy product alerts, more efficient support, and quicker service. Go to <https://calspas.com/register-your-spa.php>. Fill in your information and click “SEND WARRANTY INFO”.

### Locating the product serial number

The serial number of your spa is located on a metal plate attached to the right side of the spa panel. You will need this number to properly register your spa and activate coverage. Write this information in the space provided below.

Spa Model: \_\_\_\_\_

Spa Serial Number: \_\_\_\_\_

Date Purchased: \_\_\_\_\_

Date Installed: \_\_\_\_\_

Dealer's Phone Number: \_\_\_\_\_

Dealer's Address: \_\_\_\_\_

Copyright 2024 Lloyd's Material Supply Company, Inc.  
All rights reserved. Duplication without written consent is strictly prohibited.  
Cal Spas®, Adjustable Therapy System™, ATS™, Cal Premium™, Cal Select™, Cal Stone™, XL™ Heater, and Ultimate Fitness Spa Series™ are registered trademarks.  
Due to continuous improvement programs, all models, operation, and/or specifications are subject to change without prior notice.

LTR.1013.2024  
4/8/24 Rev B

**CONTACT INFORMATION**  
For customer service, please contact your authorized dealer immediately. If you need additional information and/or assistance, contact:

**Lloyd's Material Supply Company, Inc.**  
**Customer Service Department**  
**1462 East Ninth Street**  
**Pomona, CA 91766.**

Toll Free: 1-800-CAL-SPAS  
Fax: 1-909-629-3890

# Table of Contents





- Important Safety Instructions**..... 4
- Preparing for Your Portable Spa..... 6
- Planning the Best Location..... 6
- 240 Volt Electrical Installation..... 7
- GFCI Wiring Diagram for USA and Canada..... 8
- GFCI Testing..... 8
- Filling and Powering Your Spa..... 9
- Priming the Pump & Air Lock Bleeding..... 11
- Operating Your Spa.** 12
- TP 700 Control System..... 12
- Controller Navigation..... 14
- Set Time of Day & Temperature..... 17
- Heat Modes & Temperature Range..... 19
- Restricting Operation & Filter Cycles..... 21
- Electrical Efficiency..... 23
- Jets & LED Lighting..... 23
- Water Diverters & Air Controls..... 24
- Waterfall..... 24
- ATS Therapy System..... 25
- Water Clarity.**
- The Key to Clear Water..... 26
- Testing and Adjusting Spa Water..... 27
- Sanitation..... 28
- Ozone, Bather Load & Filter Cleaning..... 29
- Maintenance Schedule..... 30
- Troubleshooting Water Clarity Problems..... 30
- Cleaning and Maintenance.**
- Removing Pillows & Jets..... 32
- Spa Cover and Lock Installation..... 33
- Draining Your Spa & Cold Climate Draining “Winterization”..... 35
- Cleaning and Replacing Filters..... 36
- Vacation Care..... 36
- Cleaning Your Spa..... 37
- Using the Freedom Sound System..... 37
- Cal Connect Wifi Set-Up..... 39
- Appendix.**
- Replacement Parts ..... 43
- Basic Troubleshooting..... 48
- “Thermal Creep”..... 50
- Warranty Information..... 51
- Notes..... 53



# **1.IMPORTANT SAFETY INSTRUCTIONS**

## **READ AND FOLLOW ALL INSTRUCTIONS CAREFULLY!**

When using installing and using this spa, basic safety precautions should always be followed, including:

- 1.  DANGER: RISK OF SEVERE INJURY OR DROWNING!**
  - DO NOT allow children to be in or around a spa unless a responsible adult supervises them.
  - Keep the spa cover on and locked when not in use.
  - See instructions enclosed with your cover for locking procedures.
  
- 2.  DANGER: RISK OF SEVERE INJURY OR DROWNING!**
  - The suction fittings in this spa are sized to match the specific water flow created by the pump. Should the need arise to replace the suction fittings, or the pump be sure the flow rates are compatible.
  - Never operate the spa if the suction fitting or filter baskets are broken or missing. Never replace a suction fitting with one that is rated less than the flow rate marked on the original suction fitting.
  
- 3.  DANGER: RISK OF SEVERE INJURY FROM ELECTRIC SHOCK OR DEATH FROM ELECTROCUTION!**
  - Install the spa at least 5 feet (1.5 meters) from all metal surfaces. As an alternative, a spa may be installed within 5 feet (1.5 meters) of metal surfaces if each metal surface is permanently bonded by a minimum #8 AWG solid copper conductor to the outside of the spa's control box.
  - DO NOT permit any external electrical appliances, such as lights, telephones, radios, televisions, and etc., within 5 feet (1.5 meters) of the spa. Never attempt to operate any electrical device from inside the spa.
  - Replace a damaged power cord immediately.
  - DO NOT bury the power cord.
  - Connect to a grounded, grounding-type receptacle only.
  
- 4.  WARNING: RISK OF HYPERTHERMIA (OVER-HEATING) CAUSING SEVERE INJURY, BURNS, WELTS OR DEATH!**
  - Water temperature in excess of 104°F (40°C) may be injurious to your health.
  - The spa water should never exceed 104°F (40°C). Water temperatures between 100°F (38°C) and 104° F (40°C) are considered safe for a healthy adult.
  - Lower water temperatures are recommended for young children and when spa use exceeds 10 minutes.
  - Before using the spa, the user should measure the water temperature since the tolerance of water temperature-regulating devices varies.
  
- 5.  WARNING: To reduce risk of injury**
  - Prolonged exposure to hot air or water can induce hyperthermia. Hyperthermia occurs when the internal temperature of the body reaches a level between 3°F (2°C) to 6°F (4°C) above the normal body temperature of 98.6°F (37°C). While hyperthermia has many health benefits, it is important not to allow you body;s core temperature to rise above 103°F(39.5°C).
  - High water temperatures have a high potential for causing fetal damage during pregnancy. Women who are pregnant, or think they are pregnant should always check with their physician prior to spa usage.
  - The use of alcohol, drugs or medication before or during spa use may lead to unconsciousness, with the possibility of drowning.

- Persons suffering from obesity, a medical history of heart disease, low or high blood pressure, circulatory system problems or diabetes should consult a physician before using the spa.
- Persons using medications should consult a physician before using the spa since some medications may induce drowsiness while others may affect heart rate, blood pressure and circulation.

## 6. Hyperthermia

- Symptoms of excessive hyperthermia include dizziness, lethargy, drowsiness and fainting. The effects of excessive hyperthermia may include:
  - Failure to perceive heat
  - Failure to recognize the need to exit spa or hot tub
  - Unawareness of impending hazard
  - Fetal damage in pregnant women
  - Physical inability to exit spa
  - Unconsciousness

 **WARNING:** The use of alcohol drugs or medication can greatly increase the risk of fatal hyperthermia.

## 7. **DANGER: RISK OF ELECTRIC SHOCK**

- Do not permit any electric appliance, such as a light, telephone, radio, or television within 5 feet (1.5m) of a spa.

8.  **WARNING:** people with infectious diseases should not use a spa or hot tub.

9.  **WARNING:** to avoid injury exercise care when entering or exiting the spa or hot tub.

10.  **WARNING:** Do not use spa or hot tub immediately following strenuous exercise.

11.  **WARNING:** Prolonged immersion in a spa or hot tub may be injurious to your health.

12.  **CAUTION:** Maintain water chemistry in accordance with manufacturer's instructions.

13.  **WARNING:** The filter lid is a cosmetic item, do not sit or place heavy objects on the filter lid.

**SAVE THESE INSTRUCTIONS.**

## 2. Preparing for Your New Portable Spa

### Pre-Delivery Checklist

Most cities and counties require permits for exterior construction and electrical circuits. In addition, some communities have codes requiring residential barriers such as fencing and/or self-closing gates on property to prevent unsupervised access to the property by children. Your dealer can provide information on which permits may be required and how to obtain them prior to the delivery of the spa.

#### Before Delivery

- Plan your delivery route
- Choose a suitable location for the spa
- Lay a 5-8 cm concrete slab
- Install dedicated electric supply

#### After Delivery

- Place spa on Slab
- Connect electrical components

### 2.1 Planning the Best Location

#### Safety First

Do not place your spa within 10 feet (3m) of overhead power lines.

#### Consider How You Will Use Your Spa

How you intend to use your spa will help you determine where you should position it. For Example, will you use your spa for recreational or therapeutic purposes? If your spa is mainly used for family recreation be sure to leave plenty of room around it for activity. If you will use it for relaxation and therapy, you will probably want to create a specific mood around it.

#### Plan for Your Environment

If you live in a region where it snows in the winter or rains frequently, place the spa near a house entry. By doing this, you will have a place to change clothes and not be uncomfortable.

#### Consider Your Privacy

In a cold-weather climate, bare trees won't provide much privacy. Think of your spa's surroundings during all seasons to determine your best privacy options. Consider the view of your neighbors as well when you plan the location of your spa.

#### Provide a View with Your Spa

Think about the direction you will be facing when sitting in your spa. Do you have a special landscaped area in your yard that you find enjoyable? Perhaps there is an area that catches a soothing breeze during the day or a lovely sunset in the evening.

#### Keep Your Spa Clean

In planning your spa's location, consider a location where the path to and from the house can be kept clean and free of debris.

Prevent dirt and contaminants from being tracked into your spa by placing a foot mat at the spa's entrance where the bathers can clean their feet before entering your spa.

#### Allow for Service Access

Make sure the spa is positioned so that access to the equipment compartment and all side panels will not be blocked.

Many people choose to install a decorative structure around their spa. If you are installing your spa with any type of structure on the outside, such as a gazebo, remember to allow access for service. It is always best to design special installations so that the spa can still be moved, or lifted off the ground.

## 2.2 Preparing a Good Foundation

**NOTE:** We strongly recommend that a qualified, licensed contractor prepare the foundation for your spa. Damage caused by inadequate or improper foundation support is not covered by the warranty. It is the responsibility of the spa owner to provide a proper foundation for the spa.

Your spa needs a solid and level foundation. The area that it sits on must be able to support the weight of the spa, with water and occupants who use it. If the foundation is inadequate, it may shift or settle after the spa is in place, causing stress that could DAMAGE YOUR SPA SHELL AND FINISH. Place the spa on an elevated 3 to 4" / 30 cm concrete slab. Pavers, gravel, brick, sand, timbers or dirt foundations are **not** adequate to support the spa. If you are installing the spa indoors, pay close attention to the flooring beneath it. Choose flooring that will not be damaged or stained. If you are installing your spa on an elevated wood deck or other structure, it is highly recommended that you consult a structural engineer or contractor to ensure the structure will support the weight of 150 lbs per square foot (732 Kg/m<sup>2</sup>).



## 2.3 240 Volt Electrical Installation

**NOTE:** These instructions describe the only acceptable electrical wiring procedure. Spas wired in any other way will void your warranty and may result in serious injury. The electrical circuit must be installed by an electrical contractor and approved by a local building or electrical inspector. Failure to comply with state and local codes may result in a fire or personal injury and will be the sole responsibility of the spa owner.

All 240V spas must be permanently connected (hard wired) to the power supply. When installed in the United States, the electrical wiring of this spa must meet the requirements of the NEC 70 and any applicable local, state, and federal codes. The power supplied to the spa must be on a dedicated GFCI protected circuit as required by NEC 70 with no other appliances or lights sharing the power. Use copper wire with THHN insulation. DO not use aluminum wire. Use the table on the next page to determine your GFCI and wiring requirements. Wires that run over 100 feet must increase wire gauge to the next lower number. For example: A normal 50 amp GFCI with four #6 AWG copper wires that run over 100 feet would require you to go to four #4 AWG copper wires.

## 2.4 GFCI Wiring Diagram for US and Canada

Control System	GFCI Require	Wires Required
BP501G1 (one pump system)	One 40 amp GFCI	Four #8 AWG copper wires
BP501G1 (two pump system) BP501X BP20X	One 50 amp GFCI	Four #6 AWG copper wires

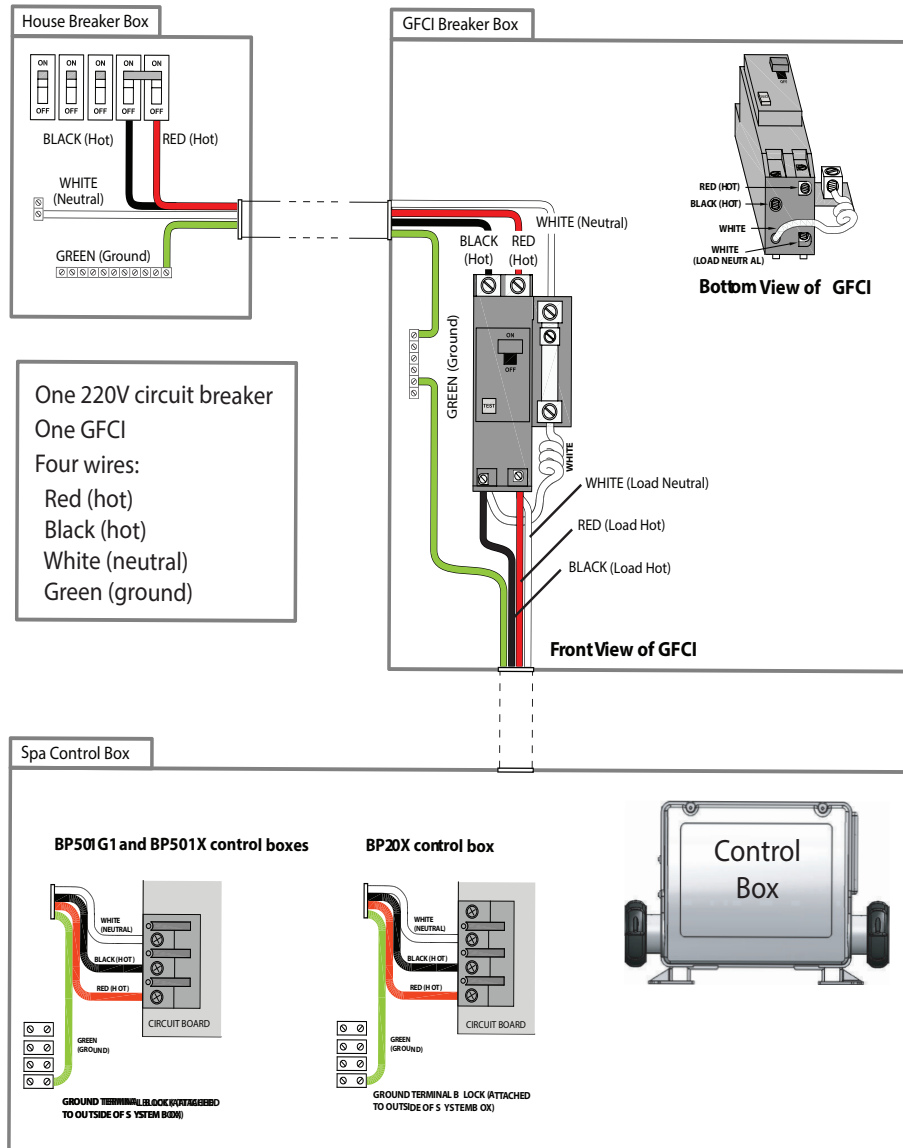

## 2.5 Testing the GFCI Breaker

Test the GFCI breaker prior to first use and periodically when the spa is powered. To test the GFCI breaker.

1. Press the TEST button on the GFCI. The GFCI will trip and the spa will shut off
2. Reset the GFCI breaker by switching the breaker to the full OFF position, wait a moment, then turn the breaker on. The spa should have power again.



## 2.7 Filling and Powering Up your Portable Spa

This applies to all spa owners **EXCEPT** those with the Cal Clarity II Bromine generator. See instructions on page 71 for bromine generator operating instructions and spa filling procedures.

### Step 1. Inspect the spa equipment.

Inspect all plumbing connections in the equipment area of your spa.

- Make sure unions in the equipment pack are tight. (Be careful not to over-tighten the plumbing fittings.)
- If your spa has gate valves, make sure they are all in the UP or OPEN position.
- Make sure the drain valve is closed and capped.

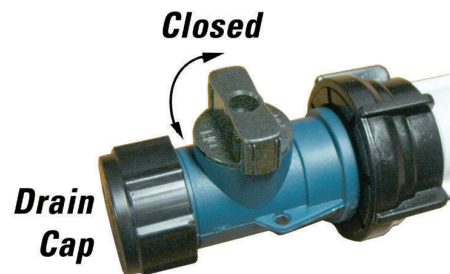
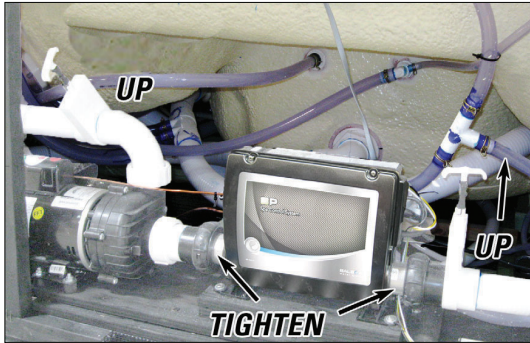

**NOTE:** Never run the spa with the gate valves closed or without water circulating for long periods of time.

### Step 2. Remove the cartridge from the filter canister.

Unscrew the cartridge and remove it.



**NOTE:** After you remove the filter, remove the plastic wrapper and soak it in water for 30 minutes before you replace it. A dry filter can allow air into the filtration system which can cause the pump to fail to prime. Never try to pull the filter cartridge while the spa is running in low or high speed (i.e., any speed).

### Step 3. Fill the spa.

Place a garden hose in the filter canister and fill your spa with **regular tap water** about six inches from the top. If the water level is too low or too high, your spa will not operate properly.

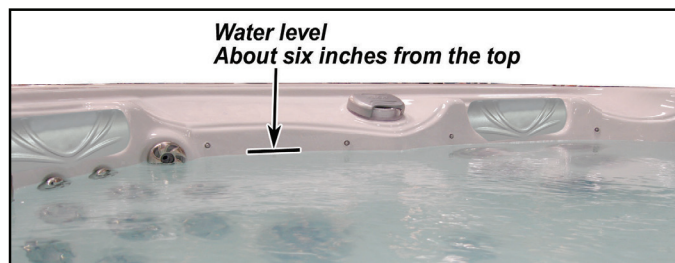

**NOTE: Never fill your spa with soft water.**

Soft water makes it impossible to maintain the proper water chemistry and may cause the water to foam, which will ultimately harm the finish of the spa and void your warranty.

You may fill your fill your spa with well water provided the following conditions are met:

1. Purchase and use a pre-filter to run the well water on the fill-up. The pre-filter will be placed before the spa filter in the fill-up flow of water.
2. Have a Total Dissolved Solids (TDS) and metals test performed by a qualified person after the fill-up process but before any spa use

**Step 4.** Turn on power to the spa.

When the spa is filled to the correct level, turn on the power at the GFCI breaker. (Ensure that the 120V spas are connected to the proper electrical outlet.)

**Step 5.** Prime the pump.

After the initial start-up sequence, the control will enter Priming Mode and display a Priming Mode screen. Only pump icons appear on the priming mode screen. During the priming mode, the heater is disabled to allow the priming process to be completed without the possibility of energizing the heater under low-flow or no flow conditions. Nothing comes on automatically, but the pump(s) can be energized by selecting the “Jet” buttons. If the spa has a Circ Pump, it can be turned on and off by pressing the “Circ” button during Priming Mode.

**Step 6.** Install the filter into the filter canister.

**NOTE: Make sure the filter has soaked at least 30 minutes before you install it. Insert the filter all the way and screw it in. Do not over-torque the cartridge during installation, just hand tighten gently.**

**Step 7.** Adjust water chemistry.

Test and adjust the water chemistry.

**Step 8.** Let the spa heat up.

When the spa has finished priming the heater will activate. Put the cover on and let the spa heat to the set temp.

## 2.8 Priming the Pump

New spa owners often have difficulty the first time they start their spa and the pump fails to prime. This can be frustrating, but these simple instructions can help you.

Sometimes air can become trapped in the pump while filling the spa. You will know this has happened when after you have filled and started the spa, the pump does not seem to function. You will hear the pump operating, but no water will be moving.

**NOTE: The pump will not work properly while air is trapped in it. Continuing to operate the pump in this way will cause damage.**

### Starting up: Priming Mode

#### Priming Mode - M019

After the initial start-up sequence, the control will enter Priming Mode and display a Priming Mode screen. Only pump icons appear on the priming mode screen. During the priming mode, the heater is disabled to allow the priming process to be completed without the possibility of energizing the heater under low-flow or no-flow conditions. Nothing comes on automatically, but the pump(s) can be energized by selecting the “Jet” buttons. If the spa has a Circ pump, it can be turned on and off by pressing the “Circ button during priming mode.

### Automatic exiting of Priming Mode

The system will automatically enter the normal heating and filtering at the end of the priming mode, which lasts 4-5 minutes.

### Bleeding Air from the Pump

If you have tried priming the pump several times unsuccessfully using the control panel, you can bleed the air from the pump manually.

1. Shut off power to the spa.
2. Using a Phillips head screwdriver, remove the front panel from the spa and locate the pump.
3. Close the gate valve on the discharge side of the pump (if your spa is installed with one.)
4. Turn the bleeder valve counter clockwise with a small pair of pliers until the air has been released from the pump.
5. If this is unsuccessful, loosen the Union nut on the side of the pump with channel locks. When air is bled out tighten the nut.
6. Turn on power to the spa and press the JETS button. If there is still air trapped in the pump, repeat steps 2 through 5 until the pump primes.

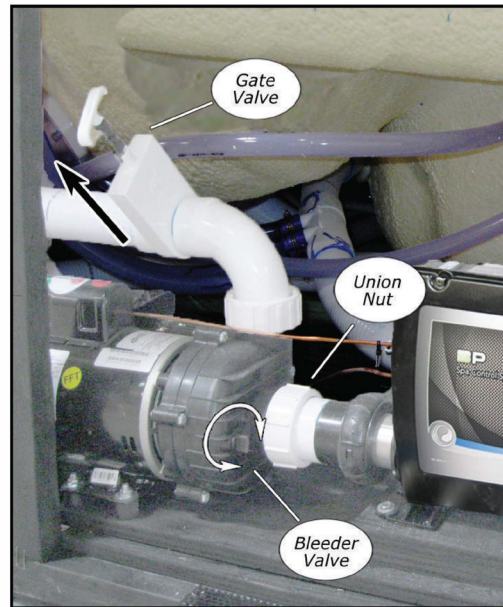

# THE MAIN SCREEN



Main Screen

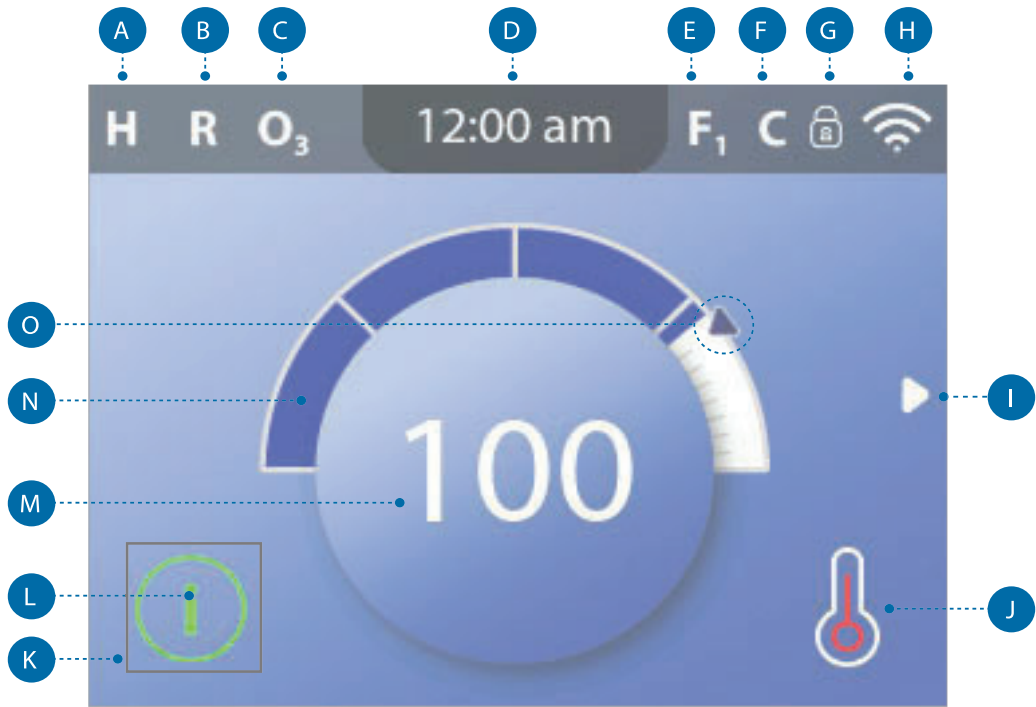

Main Screen

# MAIN SCREEN ICONS

A - Temperature Range

High: **H**

Low: **L**

B - Heat Mode

Ready: **R**

Rest: **⌘**

Ready-in-Rest: **RR**

C - Ozone Running: **O<sub>3</sub>**

D - Time-of-Day

E - Filter Cycles

Filter Cycle 1: **F<sub>1</sub>**

Filter Cycle 2: **F<sub>2</sub>** (Optional Feature)

Filter Cycles 1 & 2: **F+**

F - Cleanup Cycle (Optional Feature)

G - Panel Locked and/or Settings Locked

H - WiFi (Local or Cloud Connection)

I - Navigation Arrow

J - Heat Status

K - Selection Box

L - Message (May Appear)

 Information

 Reminder

 Error - Normal Error or Warning

 Error - Spa will not function until fixed

M - Water Temperature

Fahrenheit temperatures are displayed without decimal points. For example, 100 ° F is displayed as 100.

Celsius temperatures are displayed with decimal points. For example, 37.5 ° C is displayed as 37.5.

N - Water Temperature Bar

O - Set Temperature Arrow

# Important information about the current state of your spa is displayed on the Main screen.

## NOTE:

Not all control systems are configured the same. Spa devices, Settings, and various menu items may vary on your control panel.



# USER INTERFACE



Spa Device Buttons

Control Panel

Navigation Buttons

## Spa Device Buttons

These buttons control various spa devices, such as Jets, Lights and/or Blowers.

## Navigation Buttons

Navigate the entire menu structure with the 5 navigation buttons on the control panel.

The names shown to the right refer to the navigation buttons in this user guide. The names will be written in uppercase letters.

Operating or changing a selected item on the panel screen is generally done with the SELECT button (center button).

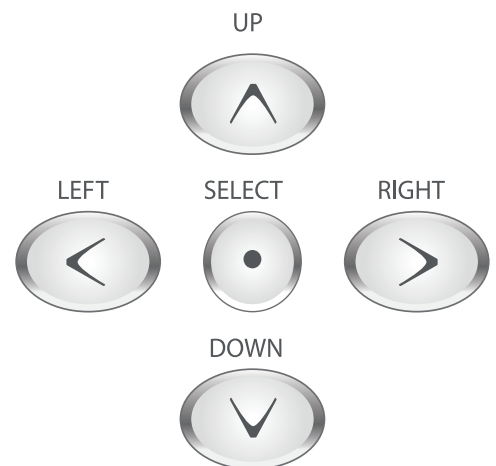

## Selection Box

The Selection box is a fundamental navigation tool. It indicates a selected item. Move the selection box by pressing the UP, DOWN, LEFT, RIGHT Navigation buttons. When an item is selected, press the SELECT navigation button to act upon the selected item. The next page shows various examples of selected items (C, I, L).

Main Screen

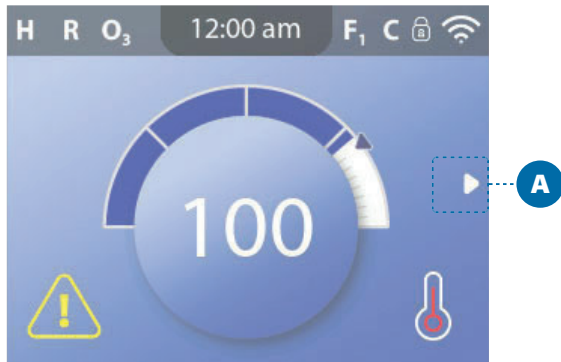

## Menu Navigation

The right Navigation arrow (A) on the Main screen indicates a menu. Press the RIGHT navigation button to enter that menu.

A selection box (C) indicates that a menu item is selected. When a menu item is selected, its name appears at the top of the screen (B). In this example the Settings menu is selected. Press the SELECT navigation button to enter the Settings window (E).

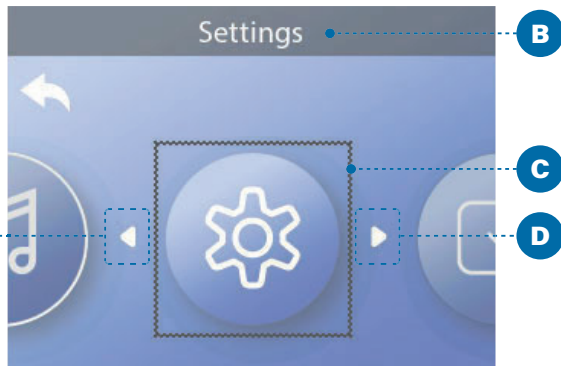

## Navigation Arrows

Navigation arrows (D, F, H, M) indicate more menu items. Each navigation arrow corresponds to a navigation button. For example, the right Navigation arrow (D) corresponds to the RIGHT navigation button. The left Navigation arrow (M) corresponds to the LEFT navigation button, etc.

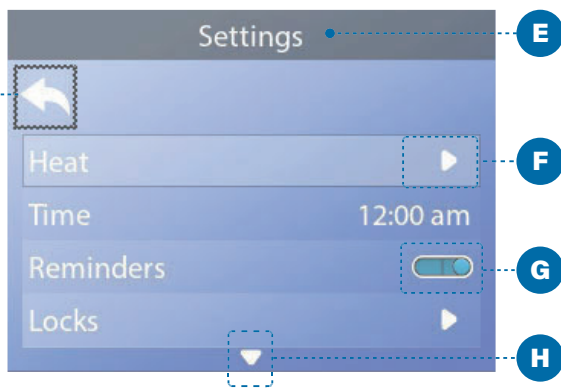

## Back Button

Use the Back button (L) to navigate back in the menus. Use the navigation buttons to select the Back button. The Selection box (L) indicates that the Back button is selected. Press the SELECT navigation button.

## On/Off Switches

In this example the Reminders setting has an On/Off switch (G). When the Reminders setting line is selected, press the SELECT navigation button to turn the switch On/Off. In this example the switch is On (G).

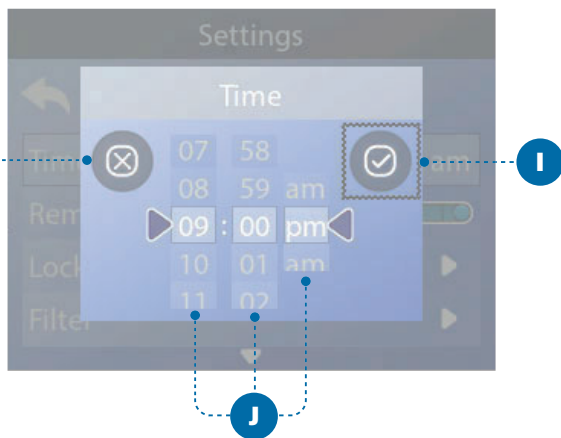

## Select, Save, Cancel

Select one of these columns (J) with the RIGHT and LEFT navigation buttons. Change the selected setting with the UP and DOWN navigation buttons. After you change the settings, choose the Save button (I) and press the SELECT navigation button. After you press SELECT, the change is complete. If you decide to cancel your new settings, select the Cancel button (K) and press the SELECT navigation button.

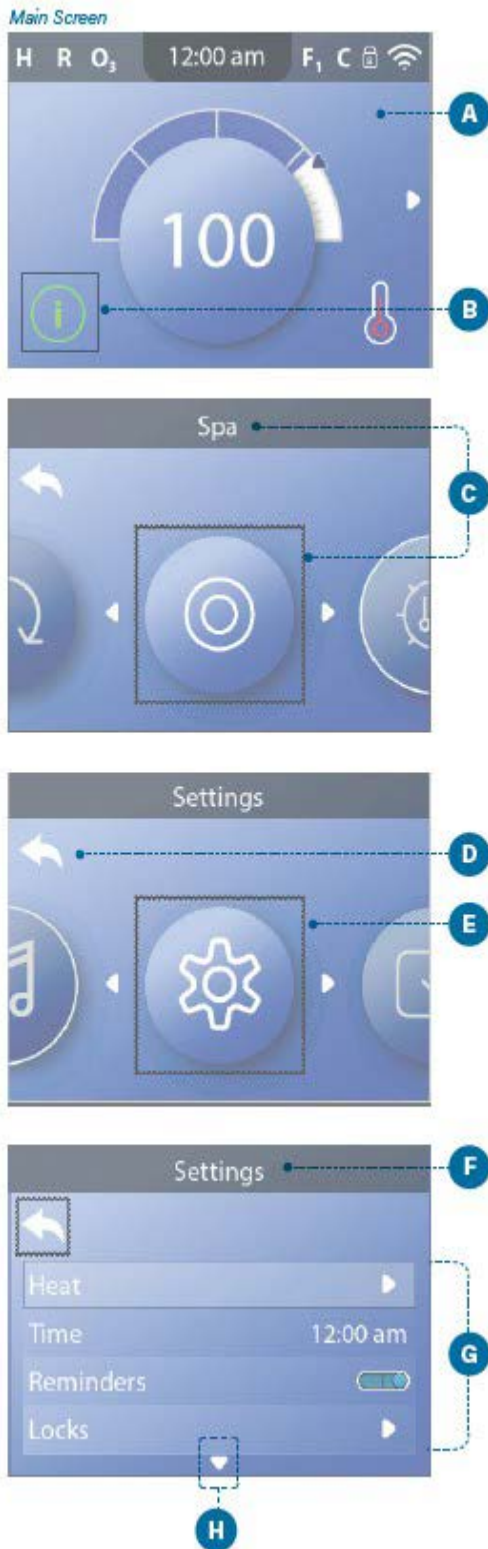

## Navigate the Main menu

1 - Start from the Main screen (A), and press the RIGHT navigation button to enter the Main menu. If the Selection box (B) is on the Message icon, you need to press the RIGHT navigation button twice to enter the Main menu.

2 - Spa is the first item in the Main menu (C). Continue pressing the RIGHT navigation button to view all items in the Main menu.

3 - If you want to navigate back to the Main screen, press the UP navigation button to select the Back button (D). Once the back button is selected, press the SELECT navigation button and the Main screen (A) will appear.

## Navigate the Settings menu

1 - Start from the Main screen (A), and press the RIGHT navigation button to enter the Main menu.

2 - Spa is the first item in the Main menu (C). Continue pressing the RIGHT navigation button until the Settings menu is selected (E).

3 - Press the SELECT navigation button to enter the Settings menu (F).

4 - The Navigation arrow (H) indicates more settings. Press the DOWN navigation button to scroll down the list.

## Press-and-Hold

If you need to navigate a long list, press-and-hold the navigation button. For example, press-and-hold the DOWN navigation button to scroll down the Settings menu list (G). The Navigation arrow (H) indicates more menu items.

## View Message Screen

1 - Start from the Main screen (A), and press the LEFT navigation button to select the Message icon (B).

2 - Pressing the SELECT navigation button to view the Message screen.

3 - The Message screen may have an Exit button or a Clear button. Select the button on the screen and press the SELECT navigation button.



# SET TIME-OF-DAY

## Be sure to set the Time-of-Day

Setting the Time-of-Day can be important for determining water filtration times and other background features.

### Follow these steps to set the time-of-day:

- 1 - Navigate to Time (A)\*
- 2 - Press the SELECT navigation button, and the Time screen will appear (B).
- 3 - Use the navigation buttons to adjust your settings (D).
- 4 - Select the Save button (C), and press the SELECT navigation button.

You have set the time-of-day.

If you do not want to save your settings, select the Cancel button (H), and press the SELECT navigation button.

If Time-of-Day has not been set, this Information icon appears (G). Select the Information icon and press the SELECT navigation button to view the corresponding message in the Information screen (F). Select the Exit button (E) and press the SELECT navigation button to exit the Information screen.

You can choose a 12-hour or 24-hour time display



## Main Screen



*Note: the Heater Status icon flashes during heater start-up; this is normal.*

## CHANGE THE SET TEMPERATURE

Follow these steps to change the Set Temperature:

1 - Start at the Main screen (A). Press the SELECT navigation button to view the temperature menu (E).

2 - Press the RIGHT and/or LEFT navigation buttons to change the Set Temperature.

The center box (D) indicates the current Set Temperature. In this example the current Set Temperature is 102.

3 - Once your desired Set Temperature is in the center box (D), press the SELECT navigation button, or just wait a few seconds.

The change is complete.

### How do I view the Water Temperature?

The Water Temperature is displayed here (B) on the Main screen.

### How do I view the Set Temperature?

Start at the Main screen (A), and press the SELECT navigation button. The Set Temperature is displayed in the center box of the temperature menu (D).

### How do I know when the water heater is On?

The center of the Heater Status icon turns red (C) when the heater is On, and it turns white when the heater is Off.

### What do the dashes indicate (F)?

When the spa is powered On, four dashes appear (F) in the Water Temperature display for one minute. The dashes indicate that the spa is checking the water temperature. After the pump runs for 1 minute, the dashes disappear and the water temperature is displayed (B). The dashes may reappear after the pump has not run for one hour.

HEAT SETTINGS

# HEAT MODES

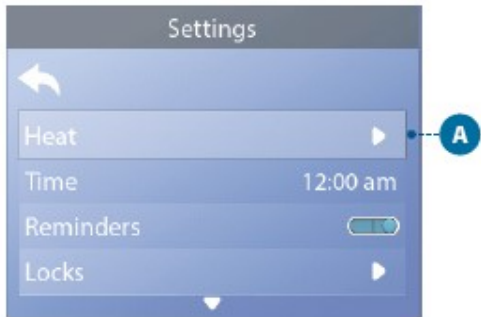

**Follow these steps to view the current Heat Mode and/or change the Heat Mode:**

- 1 - Navigate to Heat (A),\*
- 2 - Press the SELECT navigation button to view the Heat screen (B). The current Heat Mode will appear here (C). In this example the current Heat Mode is Rest. There are two Heat Modes to choose from: Ready, Rest.
- 3 - Press the SELECT navigation button to change the Heat Mode to Ready (D).

You have set the Heat Mode to Ready.

The change takes effect immediately. No need to press a Save button

Ready-In-Rest Mode is a third Heat Mode. But, it is a sub-feature of Rest Mode and is not selectable from the panel menu.

The only place you can see whether you're in Ready-in-Rest Mode is on the Main screen, where it shows all three Heat Modes in icon form.

If you are in Ready-In-Rest Mode, and you want to cancel it (ie, you want to return to Rest Mode), just go view the current Heat Mode (where it will say Rest Mode) and exit. That simple action takes you back to Rest Mode

### Where can I view the current Heat Mode on the Main screen?

The current Heat Mode is displayed here with an icon (E). In this example the current Heat Mode is Ready. The following list shows which icons may appear on the Main screen.

#### Heat Mode Icons

- Ready: **R**
- Rest: **☒**
- Ready-In-Rest: **RR**

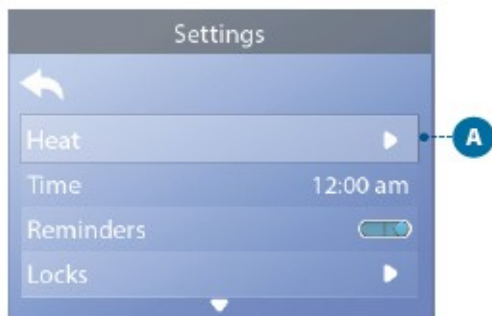

## HEAT SETTINGS

# TEMPERATURE RANGES

Follow these steps to view the current Temperature Range and/or change the Temperature Range:

1 - Navigate to Heat (A),\*

2 - Press the SELECT navigation button to view the Heat screen (B). The current Temperature Range will appear here (C). In this example the current Temperature Range is Low. There are two Temperature Ranges to choose from: High, Low.

3 - Press the SELECT navigation button to change the Temperature Range from Low to High (D).

You have set the Temperature Range to High.

The change takes effect immediately. No need to press a Save button.

## Can I see the current Temperature Range on the Main screen?

Yes. The current Temperature Range is displayed here with an icon (E). In this example the current Temperature Range is High. The following list shows which icons may appear on the Main screen.

### Temperature Range Icons

High: **H**

Low: **L**

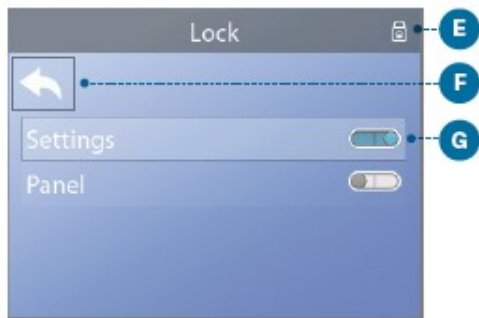

# RESTRICT OPERATIONS

The control can be restricted to prevent unwanted use or temperature adjustments.

Locking the Panel (D) prevents the controller from being used, but all automatic functions are still active.

Locking the Settings (C) allows Jets and other features to be used, but the Set Temperature and other programmed settings cannot be adjusted. Settings Lock allows access to a reduced selection of menu items. These include Filter Cycles, Invert, Information and Fault Log. They can be seen, but not changed or edited.

### Follow these steps to lock the Settings:

- 1 - Navigate to Locks (A),\*
- 2 - Press the SELECT navigation button to view the Lock screen (B).
- 3 - Navigate to Settings (C). In this example the Settings are unlocked.
- 4 - Press-and-hold the SELECT navigation button for approximately 5 seconds. After 5 seconds, the toggle switch will move to the right and turn blue (G), and a lock icon will appear (E).

You have locked the Settings.

Follow the same steps to lock/unlock the Settings and/or Panel.

- 5 - Navigate back to the Main screen. The lock icon on the Main screen (H) indicates that the Settings are locked.

### Can Settings and Panel be locked simultaneously?

Yes. The lock icon (H) appears if the Settings or the Panel or both are locked. The current lock states are indicated by the toggle switches in the Lock screen (C, D).

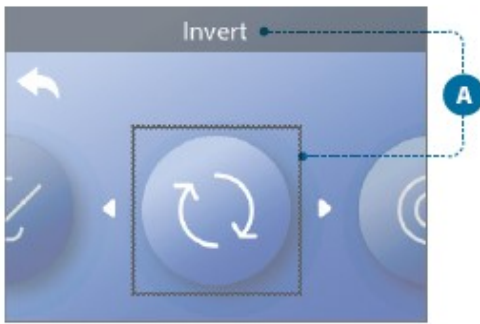

# INVERT DISPLAY

Follow these steps to invert the display:

- 1 - Navigate to Invert (A).\*
- 2 - Press the SELECT navigation button to invert the panel display (B). Every screen will be inverted.

You have inverted the display (B).

Follow the same steps to restore the default display orientation (C).



# SET FILTER CYCLE TIMES

Keep your water clean and ready to enjoy!

Follow these steps to set the Filter Cycles:

- 1 - Navigate to Filter (A).\*
- 2 - Press the SELECT navigation button to view the Filter screen (B).
- 3 - Select the start time for Filter Cycle 1 (C). Press the SELECT navigation button to view the time controls (E).
- 4 - Enter your time settings (E) with the navigation buttons.
- 5 - Select the Save button (D), and press the SELECT navigation button.

You have set the start time for Filter Cycle 1.

If you do not want to save your settings, select the Cancel button (F), and press the SELECT navigation button.

6 - Follow the same process to change the other Filter time settings if desired.

7 - Once all of the time changes are set, select the Save button (G), and press the SELECT navigation button.

You have set all of the Filter Cycle times.

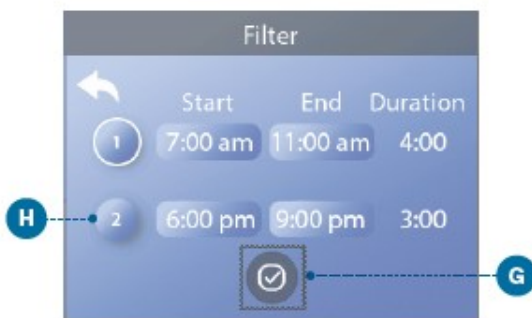
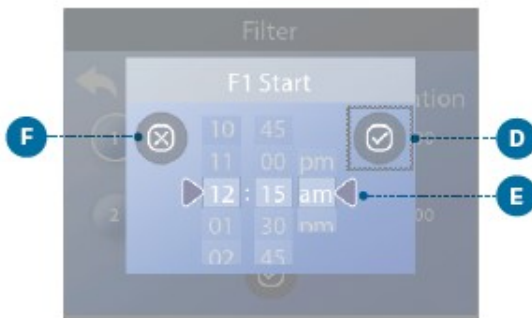
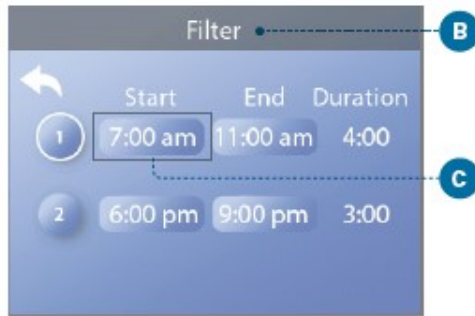

## How can you tell if Filter Cycle 2 is enabled?

Filter Cycle 2 is enabled when a white ring appears around the 2 (H). In this example there is no white ring, so Filter Cycle 2 is disabled. Filter Cycle 2 is disabled by default on many spas.

Your new spa comes equipped with an electric heater. Following the directions listed below will ensure the most efficient operation:

**NOTE: This method is only for spa usage under two hours a week.**

- Keep the spa's operating temperature 5°F below the desired usage temperature when not in use. One or two hours before use, set the temperature to the desired temperature.
- If the spa usage exceeds two hours a week, the set temperature should remain at the desired usage temperature.
- The air venturis should be used sparingly when open, water temperature drops quite rapidly and can also dissipate chemicals

Allowing the water temperature to lower more than 10°F below the desired usage temperature and reheating it prior to usage will cause the heater to operate longer than it normally would maintaining the desired temperature. Doing this will increase your operating cost and make your heater work more than necessary.

## 3.8 Jets

Almost all of the jets in your spa are adjustable. Rotating the face of an adjustable jet to the left (counter-clockwise) will decrease the amount of water flow through the jet. Rotating the face of an adjustable jet to the right (clockwise) will increase the amount of water flow through the jet. (See example shown to the right.)

Neck jets adjust in the opposite directions (counter-clockwise to increase, clockwise to decrease).

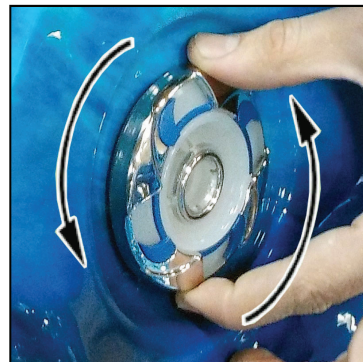

## 3.9 LED Lighting

Press the LIGHT button on the topside control panel to turn the spa light on. If your spa has perimeter LED lights, they will also light on. If your spa has perimeter LED lights, they will also light up at the same time as the spa light.

The LEDs operate in three modes:

**1. Cycle:** When you continually press the LIGHT button, the LEDs will cycle through the three main LED colors (Red, Green, and Blue) or combinations of the three that produce the following colors: light green, purple, light blue, yellow, etc.

Each time you press the button, you immediately advance to the next color in sequence or eventually a different light pattern.

**2. Flashing:** Once you have cycled through all of the colors, another press of the LIGHT button will produce a flashing pattern.

**3. Fading cycle:** The next phase of operation when you push the LIGHT button is a slow and/or fast fade random transition from one color to the next.

- If a spa is equipped with more than 100 points of light the slow fading cycle will flicker during a color change.
- Every air valve is equipped with 2 LED points.
- Perimeter LEDs take 9 points of light.
- The waterfall takes 4 points of light.

Spas with exterior corner LED lighting generally work in the same mode as described above. The variations in color and patterns provide you with multiple options to suit almost any lighting preference.

### 3.10 Diverter Knobs

Diverter knobs are 1" and 2" knobs located around the top of your spa. They allow you to divert water through jets from one side of the spa to the other, or in most cases from floor jets to all jets. This is accomplished by rotating the diverter knob to the left (counter-clockwise), decreasing the amount of water flow through a sections of jets. To increase the amount of water flow through the other section of jets, rotate the handle to the right (clockwise).



### 3.11 Air Venturis

Air venturis are the 1" knobs located around the top of your spa. Each one will let you add a mixture of air with the jet pressure. This is accomplished by rotating the air venturi knob to the left (counter-clockwise) to increase the amount of airflow through the jets. To decrease the amount of airflow through the jets, rotate the handle to the right (clockwise).



### 3.12 Waterfalls

Some spa series include optional waterfalls. When the booster pump is on, rotate the dial on top (for the cascade waterfall) or turn the knob (for the hydro streamer -- see below).







### Adjustable Therapy System

#### Pump On / Off Button:

Press this button once to turn on the ATS pump. The pump will turn on full speed with letter "H" displayed in the seven segment LED, the Pump LED light on the control panel will appear and the back light will turn on if it was off previously. Press this button a second time to turn off the ATS pump, the Pump LED light, and clear the seven segment display. The ATS pump must be on before you can use any other features of this system.

#### Pulse Mode Button:

Press this button once to turn on the pulse mode. The last pulse mode number will be displayed and the ATS pump will run in the pulse mode that it displays. There are total of 9 pulse modes and user can choose the Up or Down button to select the desired pulse mode. Press this button a second time to turn off pulse mode and return to normal pump on with letter "H" displayed. See the image for 9 pulse mode descriptions.

#### Up / Down Buttons:

These buttons only activate when pulse mode is on. They allow you to cycle through 9 pulse modes. At the end of pulse mode 9, if the Up button is pushed the system will go to "DEMO" mode. In DEMO mode, the system will cycle through all 9 pulse modes with 30 seconds for each mode and flashing letter "d1" through "d9" while cycling through each pulse mode. At the end of demo pulse mode 9, the system will exit the demo mode and return to normal Pump On with letter "H" displayed.

#### Time Out:

The Pump On will run for 15 minutes, then automatically shut off. If the Pulse Mode button is pressed during this time, the timer will reset and allow Pulse Mode to run for 15 minutes, then automatically shut off. For another 15 minutes session, press the Pump On and the Pulse Mode button. Back light will timeout 30 minutes after Pump Off.

#### Pump Protection:

If the pump is getting too hot during pulse mode (or after stop), the Pulse Mode will stop and ATS system will automatically go to a cool down cycle. During cool down cycle, the pump will turn on full speed with flashing letter "C" displayed in the panel. The ATS system will run 5 minutes and then turn off. Pulse Mode is disabled during cool down cycle.









#### Pump Purge:

To prevent water stagnation for a long time in the ATS system, the ATS system will purge water once a day. Every 24 hours from the last system run, the ATS system will turn on full speed for 20 seconds with flashing letter "P" displayed in the panel.

#### ATS Sensor:

ATS sensor is used to monitor temperature to prevent ATS system from freezing or getting too hot. If temperature is too cold, the ATS system will turn on full speed with flashing letter "F" displayed in the panel. If it is too hot, the system will turn on full speed with flashing letter "C" displayed in the panel. In these cases, it will run until pump temperature goes back to normal and the system will shut down automatically. If ATS sensor is not connected or not mounted to the system correctly, a flashing letter "E" will display in the panel when system is not running. With sensor error (flashing "E"), ATS system is still be able to operate normally but after the first 15 minutes of pulse mode, a flashing "L" will display in the panel. After the second 15 minutes of pulse mode, the system will force a cool down cycle for 30 minutes before user can use it again. There will be no freeze protection for sensor error and in some pulse modes the system will run very hot so user should fix the problem as soon as they can to enhance the pump life.



- 1  Low rolling bursts
- 2  Medium continuous bursts
- 3  Accelerated continuous bursts
- 4  Swift rolling bursts
- 5  3 gentle bursts followed by 1 vigorous burst
- 6  Quick, powerful continuous bursts
- 7  Gentle, powerful alternating bursts
- 8  Medium low rolling bursts
- 9  Extended low rolling bursts

## 4. Water Clarity

This section is intended for new spa owners with no experience with water chemistry. Everyone's knowledge with maintaining water quality is different, but there are some general concepts you need to know.

Water maintenance is not difficult, however, it does require regular attention. The most important thing to understand about taking care of your spa water is that preventative action is much easier than correcting water quality issues.

### 4.1 The Key to Clear Water

Excellent water quality is a simple matter of four things:

#### Chemical Balance

You will need to test and adjust the chemical balance of your spa water. Although this is not difficult, it needs to be done regularly. Depending on your choice of sanitizer, you need to test the level of calcium hardness, total alkalinity, and pH.

#### Sanitization

Sanitizers kill bacteria and viruses and keep the water clean. A low sanitizer level will allow microbes to grow quickly in the spa water. We recommend using either chlorine or bromine as your sanitizer. Spa owners with an ozonator also need to add sanitizer, although their requirements are different.

#### Filtration

Cleaning your filter regularly is the easiest and most effective single thing you can do to keep your water clear. A clogged or dirty filter will cause the heater and pump to work harder than they need to, possibly causing them to fail. The spa's heating system will only function with the proper amount of water flow through the system.

#### Regularity

Clear water requires regular maintenance. Establish a routine based on a regular schedule for your spa water maintenance. Maintaining your water quality helps the enjoyment of your spa and extends your spa's life by preventing damage from neglect and chemical abuse.

You have two types of testing methods to choose from:

- The reagent test kit is a method which provides a high level of accuracy. It is available in either liquid or tablet form.
- Test strips are a convenient testing method commonly used by spa owners.

### Balancing the Total Alkalinity

Total alkalinity (TA) is the measure of the total levels of carbonates, bicarbonates, hydroxides, and other alkaline substances in the water. TA can be considered a “pH buffer”. It is the measure of the ability of the water to resist changes in the pH level.

***The recommended total alkalinity is 80-120 ppm.***

If the TA is too low, the pH level will fluctuate widely from high to low. Low TA can be corrected by adding an alkalinity increaser.

If the TA is too high, the pH level will tend to be too high and may be difficult to bring down. High TA can be corrected by adding an alkalinity decreaser.

When the TA is balanced, it normally remains stable, although adding water with high or low alkalinity will raise or lower the TA level.

### Balancing the pH

The pH level is the measure of the balance between acidity and alkalinity.

If the pH is too low, it can cause corrosion of metal fixtures and the heating element. Low pH can be corrected by adding a pH increaser.

If the pH is too high, it can cause scaling by allowing metals or minerals to form deposits and stain spa surfaces. High pH can be corrected by adding a pH decreaser.

#### Ideal Water Chemistry

Testing For:	Ideal Range (ppm): Minimum	Ideal Range (ppm): Maximum
Total Alkalinity	80	120
Calcium Hardness	150	200
pH	7.2	7.6

### Balancing the Calcium Hardness

Calcium hardness (CH) is a measure of the total amount of dissolved calcium in the water. Calcium helps control the corrosive nature of the spa’s water and is why soft water is not to be used. The low calcium content of soft water is very corrosive to the equipment and can cause staining of the spa shell.

***The Recommended calcium hardness is 150-200 ppm.***

If the CH is too low, add a calcium hardness increaser.

If the CH is too high, dilute the spa water with soft water.

When the CH is balanced, it normally remains stable, although adding soft water or very hard water will raise or lower the CH level.

## 4.3 Sanitization

Sanitizers kill bacteria and other organic waste by breaking them down to non-harmful levels and are filtered out. Before you fill your spa, you need to decide which chemical sanitizer you wish to use. Consult your Cal Spas dealer for the right decision with regards to your lifestyle and spa usage.

We recommend either **bromine** or **chlorine** as your sanitizer. Both work well when maintained regularly.

**NOTE: DO NOT use trichlor. Trichlor is very acidic and the hot temperature of the spa causes it to dissolve too quickly. It will cause damage to your spa and will void your warranty.**

Whichever plan you decide on, follow it completely and don't take shortcuts. It will provide you with clean, safe, clear spa water with minimal effort. Spa owners with an ozonator still need to use a chemical sanitizer.

**NOTE: Do not use a sanitizer with the Cal Pure Salt System bromine generator. See below for instructions on its use.**

### Using Chlorine as a Sanitizer

If you choose to use chlorine as a sanitizer, only use granulated chlorine, not liquid chlorine.

Once a week, check the chlorine level using either a test strip or a reagent kit. See the table on the following page for the ideal range.

Add one or two tablespoons granulated chlorine to the spa water weekly. Note that chlorine dissipation rate will be faster at higher water temperatures and slower at lower temperatures.

When you add chlorine, open all of the jets and run the spa at high speed with the cover open for at least 30 minutes.

### Shocking the Water

In addition to using a chemical sanitizer, you will periodically need to shock the water. Shocking the water helps removed burned-out chemicals, bacteria, and other organic material from your spa's water and improves your sanitizer's effectiveness.

Add two ounces of oxidizer shock per 500 gallons once a week, after heavy bather loads or if water has strong odor.

### Using Bromine as a Sanitizer

Bromine is a very effective sanitizer that produces low chemical orders. Unlike chlorine, it can break down bacteria and other impurities to a safe level with a low burn-out rate.

Use granulated sodium bromide to establish your bromine base.

When you begin with fresh water, add two ounces of granulated bromide. Open all of the jets and run the spa at high speed with the cover open for at least 30 minutes.

Testing For:	Ideal Range (ppm) Minimum	Ideal Range (ppm) Maximum
<b>Chlorine Level:</b> Without ozonator	3.0	5.0
<b>Chlorine Level:</b> With ozonator	2.0	4.0
<b>Bromine Level:</b> Without ozonator	6.7	11.0
<b>Bromine Level:</b> With ozonator	5.7	10.0

Do not use chlorinating shock, which will damage your spa's jets and pump seals. Only use an oxidizer shock. It can be used with either chlorine or bromine sanitizers.

Spa must be running with all of the jets on high for 30 minutes with the cover open. If necessary, repeat oxidizer shock in 30 minute intervals.



## 4.4 Bather Load

“Bather Load” is the term used to describe the number of people using a spa, combined with the length of usage, and the frequency of usage. All these factors have a great effect on the spa water. The higher the bather load, the more chemicals need to be added and a longer filtration time will be needed.

Recommendations are designed for spas with average bather load (3 to 4 people, 15 minutes of usage, three times a week at 100 degrees). If your bather load exceeds these guidelines, and you experience water quality problems, increase the amount of filtration first, (go to the next higher filtration number) then if water quality is still not adequate, consult the advice of your Cal Spas dealer for additional chemical or system recommendations. Be sure to give them your bather load information.

## 4.5 Filter Cleaning

The filter is the part of your spa that removes the debris from the water and needs to be cleaned on a regular basis to maximize your spa’s filtering performance and heating efficiency.

In addition to spraying off the filter weekly to remove surface debris, your filter should be deep cleaned periodically to dissolve scale and particles that get lodged deep within the filter fibers and impede the filtration process. Even if the filter resulting in the most common spa problem—no heat, caused by a dirty filter.

We recommend you clean your filter once a month and replace it one a year or as necessary.

***It is extremely important that you never run the spa without a filter. There is a possibility that debris may be sucked into the plumbing through the filter well.***

***Set the spa in Hold Mode before you remove the filter. Hold Mode pauses all spa operations for 60 minutes for service functions like cleaning or replacing the filter.***

### Cleaning the filter

1. Remove the filter by unscrewing it and pulling it up and out.
2. Place the dirty filter into a bucket of water deep enough to cover the filter. Add 8oz. of liquid filter cleaner to the bucket of water.

***NOTE: It is a good idea to keep a spare filter to use in the spa while the dirty filter is being deep cleaned. This way, you can rotate the filters and both will last longer.***

3. Soak the filter for a minimum of 24 hours.
4. Spray the filter with a water hose. Spray each pleat carefully.
5. Reinstall the filter. Do not over-tighten.

## 4.6 Ozonator

The ozone generator releases ozone into the spa water. You will still need to test for chlorine or bromine and occasionally replenish it to return the sanitizer level to the baseline.

For spas without a circulation pump, pump 1 will run at low speed and the ozonator will run during filtration.

The spa’s control system is factory-programmed with one filter cycle that will run in the evening when energy rates are often lower. The time and duration of the filter cycle can be set according to your needs. In addition, a second filter cycle can be enabled. Filtration time may need to be increased with heavy bather load.



## 4.7 Maintenance Schedule

<b>Each time you refill the spa</b>	Follow the section “Filling and Powering up your portable spa
<b>Prior to each use</b>	Test the spa water using either test strips or a reagent test kit. Adjust chemical levels as necessary.
<b>Once a week</b>	Test the spa water using either test strips or a reagent test kit. Adjust chemical levels as necessary.  If your water source is high in calcium add stain and scale preventer.
<b>Once a month</b>	Deep clean your spa’s filter. (Follow filter cleaning instruction at the beginning of this section)
<b>Every two or four months</b>	Change the spa water. How often you change the water depends on how much you use the spa. When you change the water, you will need to: <ul style="list-style-type: none"> <li>• Clean and polish the acrylic surface page</li> <li>• Clean and treat the spa cover and pillows page</li> <li>• Deep clean the filter page</li> <li>• Refill your spa</li> </ul>
<b>Once a year</b>	Replace filter cartridges if the pleats appear frayed.

## 4.8 Troubleshooting Water Clarity Problems

<b>Problem</b>	<b>Probable Causes</b>	<b>Possible Solutions</b>
Cloudy Water	<ul style="list-style-type: none"> <li>• Dirty Filter</li> <li>• Excessive oils/ Organic matter</li> <li>• Improper sanitization</li> <li>• Suspended particles/organic matter</li> <li>• Overused or old water</li> </ul>	<ul style="list-style-type: none"> <li>• Clean filter</li> <li>• Shock spa with sanitizer</li> <li>• Add sanitizer</li> <li>• Adjust pH and/or alkalinity to recommended range</li> <li>• Run jet pump and clean filter</li> <li>• Drain and refill spa</li> </ul>
Water Odor	<ul style="list-style-type: none"> <li>• Excessive organics in water</li> <li>• Improper sanitization</li> <li>• Low pH</li> </ul>	<ul style="list-style-type: none"> <li>• Shock spa with sanitizer</li> <li>• Add sanitizer</li> <li>• Adjust pH to recommended range</li> </ul>
Musty Odor	<ul style="list-style-type: none"> <li>• Bacteria or algae growth</li> </ul>	<ul style="list-style-type: none"> <li>• Shock spa with sanitizer</li> <li>• Adjust pH to recommended range</li> </ul>

Problem	Probable Causes	Possible Solutions
Organic Buildup/ Scum Ring Around Spa	<ul style="list-style-type: none"> <li>Buildup of oils and dirt</li> </ul>	<ul style="list-style-type: none"> <li>Wipe off scum with clean rag - if severe, drain the spa, use a spa surface and tile cleaner to remove the scum and refill the spa</li> </ul>
Algae Growth	<ul style="list-style-type: none"> <li>High pH</li> <li>Low sanitizer level</li> </ul>	<ul style="list-style-type: none"> <li>Shock spa with sanitizer if problem is visible or persistent, drain, clean and refill the spa</li> </ul>
Eye Irritation	<ul style="list-style-type: none"> <li>Low pH</li> <li>Low sanitizer level</li> </ul>	<ul style="list-style-type: none"> <li>Adjust pH</li> <li>Shock spa with sanitizer and maintain sanitizer level</li> </ul>
Skin Irritation/ Rash	<ul style="list-style-type: none"> <li>Unsanitary water</li> <li>Free chlorine level above 5ppm</li> </ul>	<ul style="list-style-type: none"> <li>Shock spa with sanitizer and maintain sanitizer level</li> <li>Allow free chlorine level to drop below 5 ppm before spa use</li> </ul>
Stains	<ul style="list-style-type: none"> <li>Total alkalinity and/or pH is too low</li> <li>High iron or copper in source water</li> </ul>	<ul style="list-style-type: none"> <li>Adjust total alkalinity and/or pH</li> <li>Use a stain and scale inhibitor</li> </ul>
Scale	<ul style="list-style-type: none"> <li>High calcium content in water - total alkalinity and pH too high</li> </ul>	<ul style="list-style-type: none"> <li>Adjust total alkalinity and pH - If scale requires removal, drain the spa, scrub off the scale, refill the spa and balance water</li> <li>Use a stain and scale inhibitor</li> </ul>



## 5. Cleaning and Maintenance

### 5.1 Removing and Re-seating the Pillows

You can remove the pillows for cleaning and maintenance quickly and easily. This method works for all types of pillows.

Grab the lower edge of the pillow with both hands firmly and pull up. As you do this, the pillow inserts will pop out of the holes.

Re-seat the pillows by aligning the pillow inserts with the holes and striking the pillow hard enough to insert the pegs back into the holes.



### 5.2 Jet Removal and Replacement

Jets can be easily removed for cleaning.

Grasp the outer rim of the jet and turn it counter-clockwise until it completely stops. You may feel it slightly loosen pop out a bit from the fixture. Pull the jet out from the jet fixture. The jet will be very snug and may require some force to remove it. **DO NOT PRY OUT JETS.**

To replace the jet, place it in the fitting and turn it clockwise until it snaps in and can be rotated freely about half a turn.

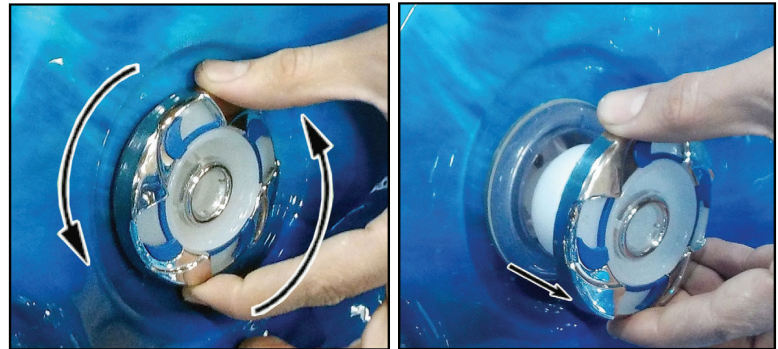



## 5.3 Spa Cover and Locking System Installation

**Important! Keep the spa covered when not in use!**

- Covered spas will use less electricity in maintaining your set temperature .
- Covering your spa will protect you spa's finish from the sun's ultraviolet rays.
- You are required to keep the spa covered to maintain warranty coverage.
- Covering your spa helps prevent children from drowning in your spa.

In addition, while the spa cover is rigid, it is not designed to support any weight. Therefore, as a safety precaution and to preserve the life of your cover, you must not sit, stand, or lie on it, nor should you place objects of any kind on top of it.

**Step 1.** Place cover on spa. Make sure it is correctly positioned.



**Step 2.** Position the tie-down hardware (attached to the straps of your cover) on the side of the spa so they are easily reached by the cover tie-down straps.



**Step 3.** With the straps pulled taut (but not overly tight), lightly drill the location for screw placement. Gently drill 3 holes - one for each screw slot in the lock. (If you do not have a low torque drill, use the lowest torque setting on the drill you have.) DO NOT drill all the way in but instead just make a guide for starters.

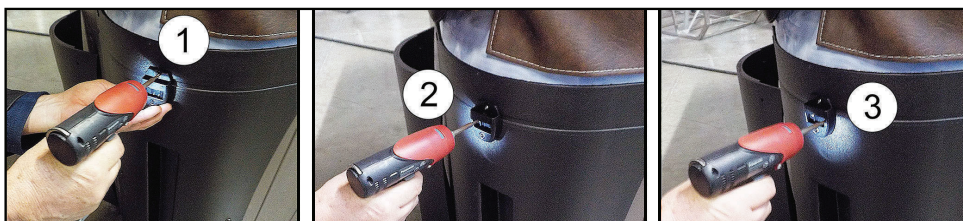

**Step 4.** Use a screwdriver to finish screwing in the 3 screws. (Repeat this process for the other 3 corners.)

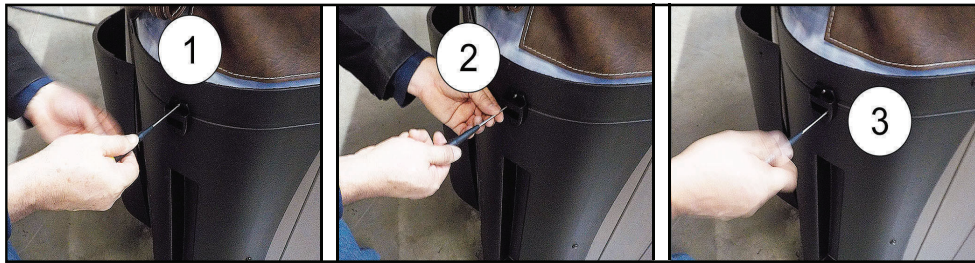

**Step 5.** Keep the cover fastened down at all times when not in use. Locking hardware may be locked with a key (which is provided).



**Step 6.** The provided key will allow you to lock down spa access.

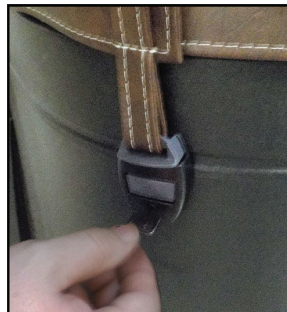

**WARNING**  
**AVOID**  
**DROWNING**  
**RISK**

**FAILURE TO FOLLOW INSTRUCTIONS MAY RESULT IN INJURY OR DROWNING  
NON-SECURED OR IMPROPERLY SECURED COVERS ARE A HAZARD.  
REMOVE COVER COMPLETELY BEFORE ENTRY OF BATHERS.  
ENTRAPMENT POSSIBLE.  
KEEP COVER ON SPA AND LOCKED WHEN NOT IN USE**

## 5.4 Draining Your Portable Spa

Your spa should be drained every four to six months for cleaning and maintenance and refilled with fresh tap water. Before you begin turn off power to the spa at the breaker and remove all filters.

### Step 1. Locate your drain.

Pull the knob out of the cabinet. The cabinet drain is screwed into the drain pull knob.



### Step 2. Remove the cap.

Make sure the valve is in the closed position, then unscrew and remove the cap. Unscrew the cap.



### Step 3. Connect valve to a garden hose.

Attach a garden hose to the hose-bib fixture. Place the other end of the garden hose where you would like the water to drain.

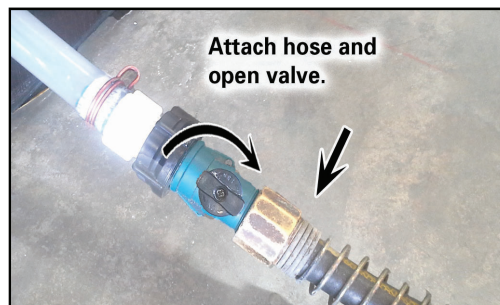

### Step 4. Drain the spa.

Turn the valve on the hose-bib fixture to open the drain. When the spa has drained completely, turn the valve on the hose-bib fixture, remove garden hose and replace the cap.

## 5.5 Winterizing (Cold Climate Draining)

Depending on your region in your country, the temperature could drop below 32°F (0°C). If you are in one of those regions, we recommend that you always have your spa full of water and running at normal spa temperatures (80°F to 100°F, 26.7°C to 37.8°C). This will help reduce the risk of freezing water in your spa and in your spa's equipment.

**WARNING: If you find the need to drain your spa, be aware of the potential of freezing in your spas equipment and plumbing. Even if the directions below are followed perfectly, there is no guarantee that your spa will not suffer freeze damage. Freeze damage is not covered by your warranty.**

1. Open all filter covers.
2. Remove the filter baskets and filters.
3. Drain your spa completely
4. Vacuum water from the spa's main drain fitting with a wet/dry vacuum
5. Open the bleeder valves on the pumps.
6. For spas with the UV lamp chamber mounted flat on the equipment floor: Loosen the quartz tube nut to let the water drain from the UV lamp chamber.
7. Disconnect the unions from both sides of the pump.
8. Blow any remaining water out of the jets and equipment area with the wet/dry vacuum.
9. When it has completely finished draining, replace the quartz tube in the UV lamp chamber and re-tighten the nut. Close the bleeder valves and re-connect the unions on the pumps. Replace the filter baskets and filters.
10. Cover your spa with a good spa cover and an all-weather tarp to ensure that neither rain nor snow enters the spa.

## 5.6 Cleaning and Replacing the Filter

Filtration is one of the most important steps you can take to ensure clean, clear water. It is far less expensive to fix water clarity problems by properly filtering your spa than by using excessive amounts of chemicals, excessive filtration times, or by water replacement.

## 5.7 Vacation Care

You can leave your spa unattended for up to two weeks if you follow these instructions.

**ALWAYS lock your cover using the cover locks if you plan to be away from home and the spa is filled with water.**

1. Select the Low Range temp choice used for vacation mode.
2. adjust the pH.
3. Shock the water (add either chlorine or bromine sanitizer).
4. When you return, check and adjust the pH and shock the water.

If you will not be using your spa for longer than 14 days and a spa maintenance service is not available, we strongly recommend you drain or winterize your spa.

## 5.8 Cleaning Your Spa

### Spa Cover and Pillows

Due to constant punishment your spa cover and pillows receive, you should protect them by applying a vinyl and leather cleaner as part of your monthly maintenance plan. Use a product that is specifically designed to protect spa covers and pillows from chemical and ultraviolet light damage without leaving an oily residue behind that is normally associated with common automotive vinyl protectants.

**Warning: DO NOT use automotive vinyl protectants on spa covers or pillows. These products are generally oil-based and will cause severe water clarity issues that are difficult to correct.**

### Spa Shell

Each time you drain your spa, before you refill it you should clean your spa shell with an all purpose-cleaner and apply a coat of surface protectant.

Use a low detergent, non-abrasive cleaner specifically formulated to clean the spa without damaging its acrylic finish.

Use a non-oil based surface protectant that is specifically formulated to protect the spa’s finish from the chemicals and minerals associated with normal spa use.

## 5.9 Using the Freedom Sound System

The Freedom Sound System™ entertainment option contains a Bluetooth-enabled speaker system that is available for certain Cal Spa models. Any Bluetooth-enabled device can be used to play audio through your spa. Before you can use the sound system, you need to pair the Bluetooth module with your device. The Bluetooth module is installed within the spa cabinet. Everything can be performed with your Bluetooth device. The example shown below is from an iPhone device. Your device may appear differently. Before you begin, make sure Bluetooth is enabled on your device.

1. Select Bluetooth from your device’s option list.
2. Select **Aquatic-AV...** from the list of available devices to pair.
3. Your iPhone device will ask for a code: the code is 0000.
4. Allow your device to pair with the spa’s Bluetooth module.
5. When the devices have been connected, the device **Aquatic-AV...** will be highlighted.

Only one Bluetooth device can be paired with the Freedom Sound System™ at any time.

(For Android users, the systems will pair automatically - no code is needed.)

Once your device is paired and connected, all sounds from your device will be played through the sound system, including system sounds and telephone.

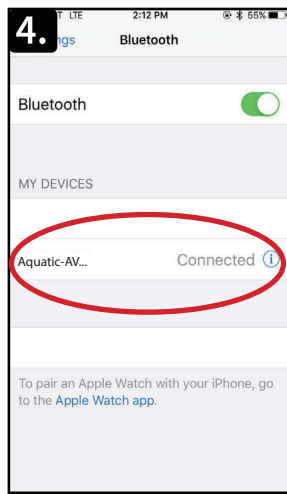
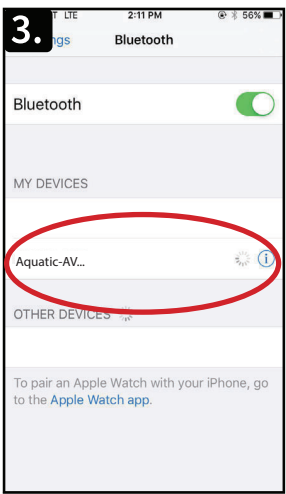
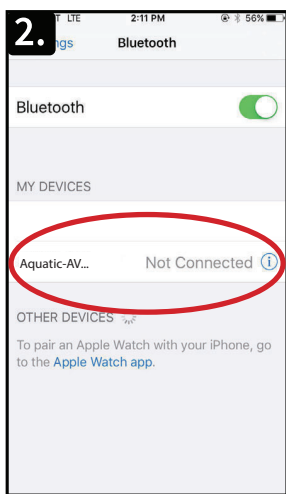
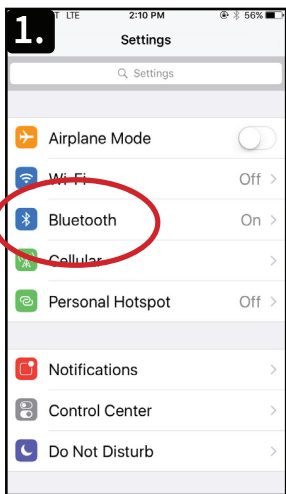



# Cal Connect RF Set Up Guide

**Congratulations!** Welcome to Cal Connect Control My Spa, the smart control system for spa monitoring on the go. With Cal Connect you will be able to control/monitor water temperature, control pump operation, adjust filtration, and monitor/control any activity occurring within your spa.

This Quick Start guide will help you with initial set up of your RF module.

**NOTE: The Cal Connect Module works on 2.4 Ghz networks only. Inspect your router to confirm 2.4 Ghz support.**

The Cal Connect uses two modules, one that connects to the home router and one that connects to the spas control box, both modules must have matching serial numbers located on the back of each of the modules. Connect your home module first before proceeding.

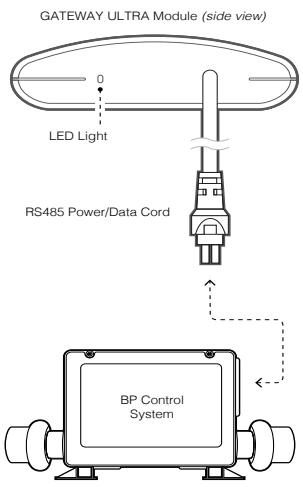
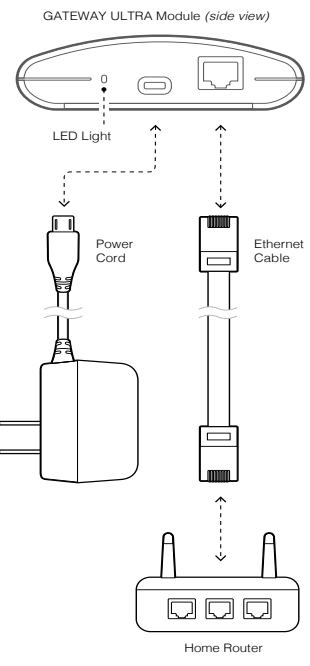
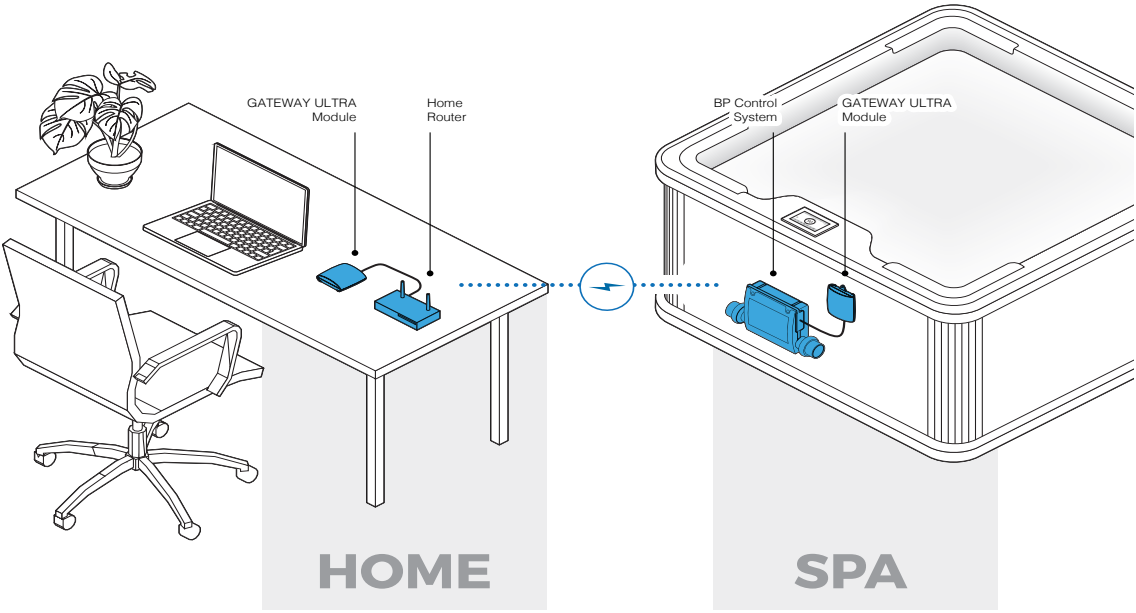

## Download the Control My Spa App

To Begin the initial set up of the Cal Connect system, download the "Control My Spa" app by Balboa Water Group from the App Store or Google Play Store.

Before starting the app, have your CMS code in hand. This is a unique code provided to you by your dealer.

**If you do not have a CMS Code, Please Contact your dealer.**

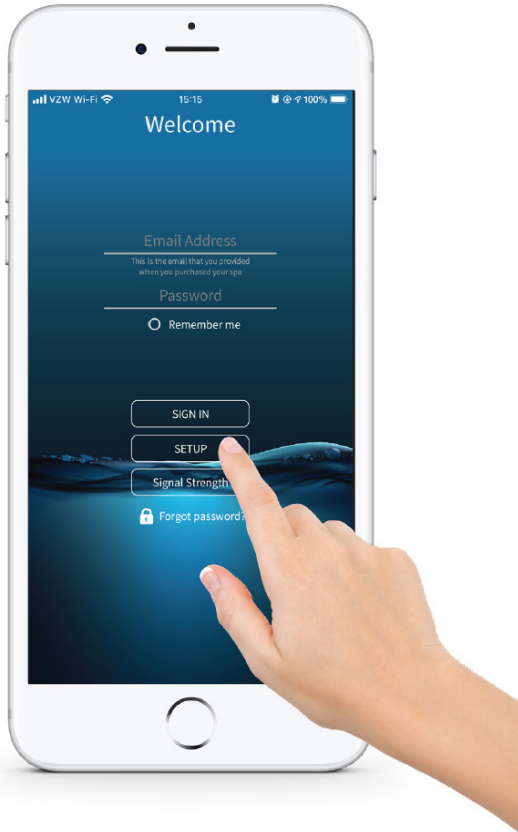
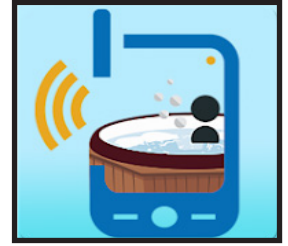

**1-** In your phone setting ensure that your bluetooth setting is toggled on, during initial set up the module uses bluetooth to communicate.

**2-** To set your module into discovery mode, flip your spa GFCI breaker off and back on again.

**3-** Next, open the Control My Spa app and select "SETUP" to begin the process of registering your modules.

**4-** Stand next to the spa, preferably near the control panel of your spa. your mobile device will begin searching for the spa module.

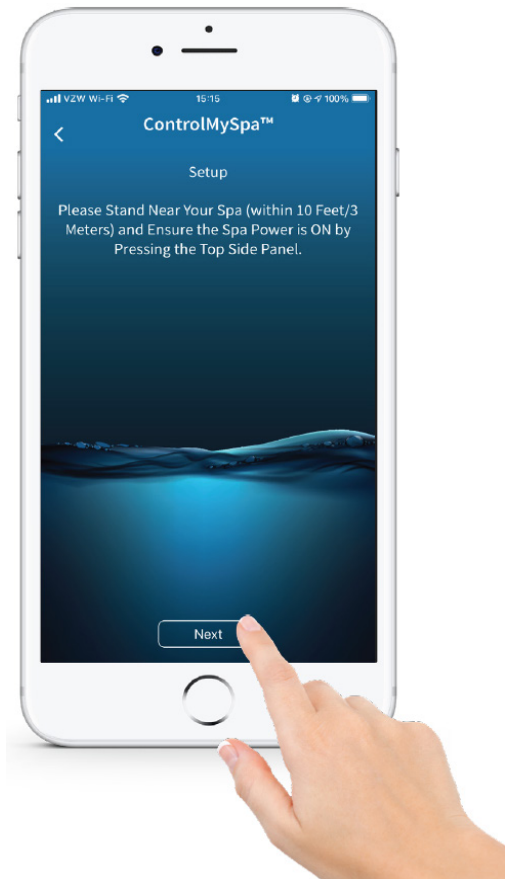



# Control My Spa Set-Up



5- The App will begin scanning for the spas wifi module. within a few seconds the module serial number should appear.

6- Select the "Yes" option once the serial number appears on screen and proceed with the following steps.

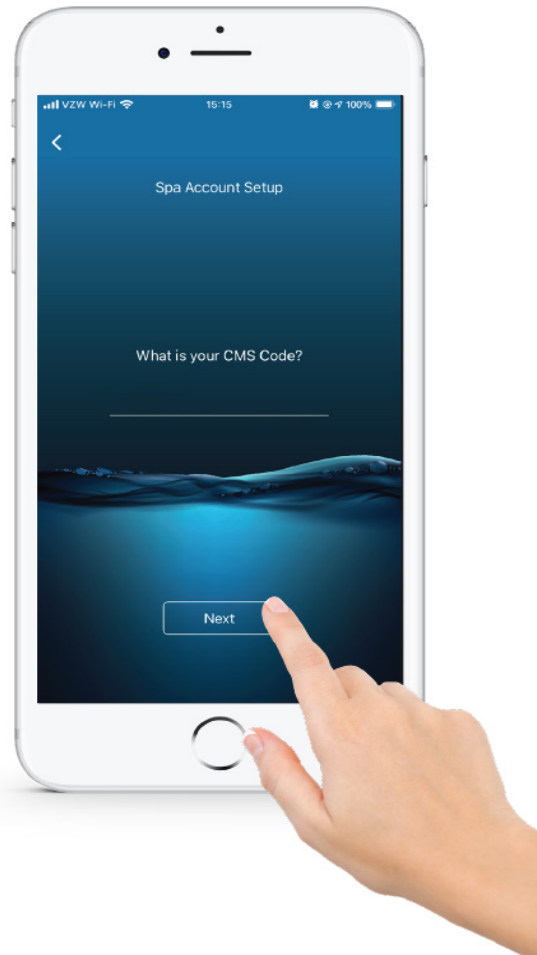

7- The app will request your CMS Code to proceed with creating an account to control your spa.

**If a CMS Code was not given to you, please contact your dealer.**

8- Proceed with account creation, once completed with all steps log into your newly created account on the main page of the app. once you are logged in you should have control of your spa system within 5-10 minutes.

For more details on installation and basic troubleshooting you can download the complete installation/owners manual on <https://www.balboawatergroup.com/getdoc.cfm?id=2392> To download the full manual.



**Black "Y" Pillow Carbon Fiber Design S-01-4324**  
ACC01401102



**Filters**

**Filter Cartridge Anti-bacterial - 50 sq. ft.**  
Part #: FIL50-5D13H15FCT-3



**LED Lights**

**1 to 3 ext. cord**  
Part #: LIT16100335



**1 to 1 port ext. cord**  
Part #: LIT16100338



**Interior light with logic (7 LED)**  
Part #: LIT16100333



**Interior light without logic (7 LED)**  
Part #: LIT16100336

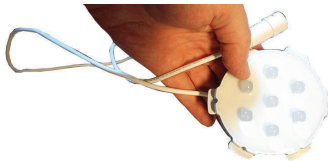

**Main light housing, LED lens, fitting nut**  
Part #: LIT16100336



**Waterfalls**

**Cascade II Waterfall Curved black Textured with Valve and Logo 12-3/8" '14**  
Part #: PLU21800828



## TeleWeir Skimmers

50 Square Foot teleweir skimmer:  
 Filter attaching cap assembly: FIL11700013  
 Filter Skimmer inner pipe: FIL1170012



## LED Lights

1-LED light string  
 Part #: LIT16100330



2-LED light string  
 Part #: LIT16100331



4-LED light string  
 Part #: LIT16100332



## SUCTION

Part # PLU644-5419CDCL V  
 5"DESIGNER PRO-SUCT. ASSY. 2.5"S  
 2-TONE, ELL GASK. (EPDM 50 SHORE) &  
 LOAD WASHER

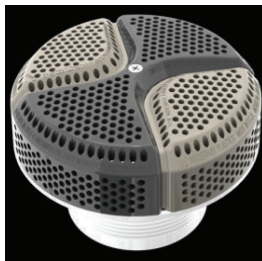

## AIR CONTROL

Part # PLUCS6603709-CDCL  
 "Cal Spas 1" Air Control Complete  
 Assembly, Velocity Style, CDG/HLG



Part # PLUCS6054309-CDCL  
 "Cal Spas 1" Air Control Complete  
 Assembly, Velocity Style, CDG/HLG"

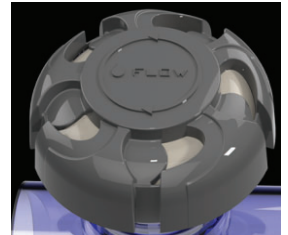

Part # PLUCS6053309-CDCL  
 "Cal Spas 2" Top Access Diverter  
 Valve Sub-Assembly, Velocity  
 Style,CDG/HLG"

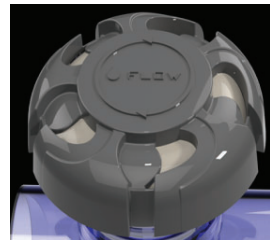

### CLUSTER JETS

**Part#:** PLUCS2441009S-CDCL  
 4" Cluster Storm Internal, Directional  
 Velocity Metal



**Part#:** PLUCS2442059S-CDCL  
 3" Mini Storm Internal, Multi-massage  
 Velocity Metal



**Part#:** PLUCS2441029S-CDCL  
 2" Cluster Storm Internal, Twin  
 Velocity Metal



### POLY JETS

**Part#:** PLUCS2443009SS-CDCL  
 4" Poly Storm Directional Eyeball  
 Metal Velocity



### MINI JETS

**Part#:** PLUCS2442009SS-CDCL  
 3" Mini Storm Directional Eyeball  
 Metal Velocity



**Part#:** PLUCS2443029SS-CDCL  
 4" Poly Storm, Roto Eyeball  
 Metal Velocity



**Part#:** PLUCS2444049S-CDCL  
 5" Power Storm, Twister  
 Velocity Metal



### POWER JETS

**Part#:** PLUCS2444009SS-CDCL  
5" Power Storm, Directional Eyeball  
Velocity Metal



**Part#:** PLUCS2444019S-CDCL  
Power Storm Tri Directional Eyeball  
Velocity Metal



**Part#:** PLUCS2444059S-CDCL  
Power Storm Multi-Massage  
Velocity Metal



### WHIRLPOOL JETS

**Part#:** PLUCS2394009S-CDCL  
Adjustable Whirlpool  
Velocity Metal

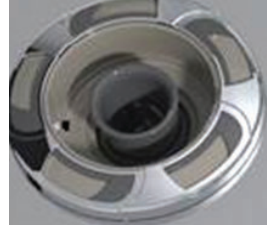

### Cover Lock and Keys

Part #: ACC01800026, ACC01800020



### Replacement of Cabinet Panels

The complete selection of replacement cabinets for all models is very extensive and too lengthy for this owner's manual. To order replacement panels for your spa, visit [www.quickspaparts.com](http://www.quickspaparts.com)

### Covers

All spa covers are designed with a tapered height, angling downward from the center to the sides to drive off rain and prevent water from pooling. The covers listed below are filled with either 1 lb., 15. lbs., or 2.0 lbs. foam.

#### Basic

4" - 2.5"  
1.5 lbs. foam



#### Deluxe

5" - 3"  
2.0 lbs. foam



#### 84" x 84" (7 foot spas)

Fits spa models: PL-760L, PL760B, PPL7B

	Basic	Standard
Black	COV848BBK-3	COV8484SBK-3
Grey	COV8484BG-3	COV8484SG-3
Brown	COV8484BDB-3	COV8484SDB-3

#### 93" x 93" (8 foot spas)

Fits spa models: PL-860L, PL-861B, PL880L, PL-881B, PPL8B

	Basic	Standard	Deluxe
Black	COV9393BBK-3	COV9393SBK-3	COV9393DBK-3
Grey	COV9393BG-3	COV9393SG-3	COV9393DG-3
Brown	COV9393BDB-3	COV9393SDB-3	COV9393DDB-3

## Basic Troubleshooting

The troubleshooting guidance provided here is intended to cover the most common problems a spa owner may encounter. For more in-depth troubleshooting, go to [www.calspas.com/troubleshooting](http://www.calspas.com/troubleshooting).

Symptom	Possible Solutions
---------	--------------------

### Problems starting up

Pump won't prime	See priming instructions
Breaker keeps shutting off	Reset the GFCI breaker. If this continues, contact your dealer or a qualified spa technician.

### Power and system problems

System won't start up or breaker keeps shutting off	Power may be shut off. Turn on GFCI circuit breaker. If this continues, contact your dealer or a qualified spa technician.
Control panel doesn't respond	Turn on or reset the GFCI circuit breaker. If this does not solve the problem, contact your dealer or a qualified spa technician.  If you hear the pump running but the control panel doesn't respond, contact your dealer
Spa does not turn off	Spa may be trying to heat up. Check if spa is in Ready or Rest mode  In cold climates, if spa is not equipped with full foam or any kind of insulation, it will try to maintain the set temperature. Set the spa to low temperature range and set the temperature to 80°F.  Spa may be in filter cycle. If it is, this is normal and no adjustment is necessary.
Message on the control panel	There may be a problem. See Diagnostic Messages

### Heat problems

Spa water does not get hot	Spa may be in low temperature range. Set the spa to high temperature range. The filter may be dirty or may need to be replaced. Clean or replace the filter. The water level may be too low. Fill the spa with water level at 4 to 6 inches from the top. The temperature is not turned up high enough. Raise temperature on topside control. Cover the spa. The cover will keep heat in the spa and help keep heat from escaping. Make sure cover is on at all times when spa is not in use. The heater element may be old, deteriorated, coated with scale, or defective. Contact your dealer for more assistance. The gate valves may be partially or completely closed. NEVER OPERATE YOUR SPA WITH THE GATE VALVES CLOSED!
----------------------------	---





**Symptom**                      **Possible Solutions**

Spa overheats - temperature greater than 110°F / 43°C

Overheating can occur during summer months and may not necessarily indicate a malfunction. When it occurs, a message code may also appear on the control panel.

Temperature may be set too high. Turn the set temperature down to a lower temperature.

Filtration time may be too long. Turn the filtration cycles down during the warm months.

The spa may not be properly ventilated. Make sure the front of the spa is not blocked to allow air flow.

High speed pumps may have been running too long. Limit pump running time to no more than 15 to 30 minutes.

**Water pressure problems**

Low water pressure

Jet valves may be partially or fully closed. Open the jet valves.

Filter cartridge may be dirty. Clean or replace the filter.

Pump may have airlock. Remove airlock by priming spa

The suction fittings may be blocked. Remove any debris that may be blocking them.

The filter skimmer may be blocked. Remove the blockage.

Gate valves may be closed. Open gate valves. Note: Never operate your spa with the gate valves closed!

Spa may be running in filtration mode. Press JETS or JETS 1 button to turn on high speed pump.

No water pressure (no water stream from any jets)

Power may be switched off. Turn the power back on.

The pump may be defective. After you have tried all other troubleshooting, contact your dealer for assistance.

Jets surge on and off

Water level may be too low. Add water to normal level.

**Pump problems**

Pump runs constantly – will not shut off

There may be a problem with circuit board. Contact your dealer.

Noisy pump

The water level may be too low. Fill the spa with water level at 4 to 6 inches from the top.

Filter cartridge may be dirty. Clean or replace the filter.

Pump may have airlock. Remove airlock by priming spa

The suction fittings may be blocked. Remove any debris that may be blocking the suction fittings.

Gate valves may be closed. Open gate valves. Note: Never operate your spa with the gate valves closed!

Air may be leaking into the suction line. Contact your dealer for assistance.

Debris may be inside the pump. Contact your dealer for assistance.

Noise may be a sign of damage. Contact your dealer for service.



Symptom	Possible Solutions
Pump turns off during operation	<p>Automatic timer may have completed its cycle. Press JETS or JETS 1 button to start the cycle again.</p> <p>Pump may have overheated due to the vents on the equipment door being blocked. Make sure the front of the spa is not blocked to allow air flow.</p> <p>The pump motor may be defective. Contact your dealer for assistance.</p>
Pump has a burning smell while running	<p>A burning smell may be a sign of damage. Contact your dealer for service.</p>
Pump does not run	<p>Pump may have over heated. Let it cool for an hour and try operating the spa for a shorter time.</p> <p>Power to the spa may be shut off. Turn on or reset the GFCI circuit breaker. If this does not solve the problem, contact your dealer or a qualified spa technician.</p>

## “Thermal Creep”

Cal Spas are designed with energy-efficient components and systems that are meant to sustain heat generated by the equipment, which is then cycled back into the spa water. In hot weather or in situations where the spa is set to extended run times, Thermal Creep may occur. Thermal Creep is a condition where the measured water temperature can be higher than the set temperature. To manage Thermal Creep you may:

**Vent your cover.** This means placing a folded cloth about ¾” (2cm) thick under all four corners of the cover before you lock the cover down.

**Open your cover.** Opening the cover at night will also quickly cool the water down if desired.

**Open all air controls.** Set your filtration cycles to run during the cooler times of the day or night.

**Reduce the length of your filter cycles.**

**Visit your local dealer for additional guidance.**

Since Thermal Creep only occurs in well-insulated hot tubs, it is not indicative of something that is wrong with your spa or its equipment.

# LIMITED WARRANTY

This Limited Warranty is extended to the original purchaser of the spa produced by Lloyd’s Material Supply company, Inc. Which Manufactures the Cal Spas brand portable spa manufactured after January 1, 2024 and installed for residential use in the United States of America and Canada. This Warranty begins on the date of delivery of the spa, but in no event later than one year from the date of manufacture.

**Shell Structural**  
Warrantied against water loss due to defects in the spa shell. 10 years

**Shell Finish**  
Warrantied against blistering, cracking, or delaminating of the interior spa shell. 7 years

**Equipment and Controls**  
Electrical Equipment components- specifically limited to the pumps, standard titanium heater, and control system, are warrantied against malfunction due to defects in workmanship or materials. 5 years

**Plumbing**  
Warrantied against leaks due to defects in workmanship or materials 5 years

**Cabinet - synthetic or fiberglass**  
Warrantied against defects in workmanship or materials. Normal wear and weathering of the finish will occur naturally over time and are not defects. 5 years

**Warranties for Other Components**

The fuses, headrests, cabinet finish, cal grip, labels, and filters are warrantied to be free of defects in workmanship and material at the time of delivery. The factory installed water purification system & salt system is warrantied against malfunction due to defects in workmanship or material for one year from the original date of the spa delivery. All stereo-related components (receiver, speakers, sub-woofer, power supply, Bluetooth antenna, etc) are warrantied against malfunction due to defects in workmanship and material for one year from the original date of delivery. All other factory-installed components not mentioned specifically, including, but not limited to the wood frame, jets, diverter valves, LED lighting systems, filter lids, and mechanical components, are warrantied against malfunction due to defects in workmanship and material for two years from the original date of delivery.

The insulating spa cover delivered with the spa is warrantied to be free of defects in workmanship and materials for 90 days for Escape & Escape X spas.

**Genuine Cal Spas Parts & Accessories**

This Limited Warranty is void if Lloyd’s Material Supply Company, Inc., manufacturer of the Cal Spas brand or its designated representative determines that the spa has been subjected to damage or failure due to installation of aftermarket parts that are not genuine Cal Spas branded parts and accessories. This disclaimer includes, but is not limited to filters, UV bulbs, ozone systems, salt systems, repair parts and other accessories. Genuine Cal Spas brand parts and accessories are built to our highest standards of quality, durability and performance, and they are designed to work with your spa to ensure optimal performance and function.

**Performance**

This warranty begins on the date of delivery of the spa, but in no event later than one year from the date of manufacture. To obtain service in the event of a defect covered by this Limited Warranty, notify your Cal Spas dealer or Cal spas as soon as possible and use all reasonable means to protect the spa from further damage. Upon proof of purchase, a designated service representative will correct the defect subject to the terms and conditions contained in this Limited Warranty. There will be no charge for parts or Labor to repair the defect, although providing access to affect the repair is your responsibility as the spa owner. Freight charges for replacement parts is the responsibility of the spa owner. The servicing dealer may charge the owner a travel/service fee as well as a diagnose fee if the cause of the issue is unknown, these charges are not covered under warranty.



In the event that the spa is removed to a repair facility for repair and reinstalled, the cost of removal and re-installation will be your responsibility as the spa owner. If Lloyd's Material Supply Company Inc., The manufacture of the Cal Spa brand determines that repair of the covered defect is not feasible, it reserves the right to provide a replacement spa of equal or lesser value to the original purchase price. In such an event reasonable costs for removal of the original spa, shipping costs from the factory for the replacement spa and delivery and installation of the replacement spa will be the responsibility of the spa owner. The replacement spa will carry the balance of the original spa's warranty. Spa covers are not included. This warranty ends either by specified time frame, owner-transfer of the spa, relocation, or installation of any component other than by the manufacture.

#### **Warranty Limitations**

This Limited Warranty is void if Cal Spas or its designated representative determines that the spa has been subjected to alteration, neglect, misuse or abuse, or freight damage caused by the common carrier; any repairs have been attempted by anyone other than a designated representative; the failure is caused by accident, acts of God or other causes beyond the control of the Manufacturer including acts of nature (damage caused by animals, rodents, or other pests) are not covered by this warranty, additionally; neglect, misuse and abuse include any installation, operation or maintenance of the spa other than in accordance with the instructions contained in the owner's manual provided with the spa, including but not limited to the failure to maintain proper water chemistry and chemical balance and the use of abrasive or improper cleaners or non-genuine parts and accessories. This Limited Warranty does not provide coverage for any item attached to or installed on the spa after the date of manufacture or for gaining access to any component for repair or replacement. Spa units in commercial use are excluded from any coverage whatsoever. The spa owner accepts liability for repair work performed by anyone other than Lloyd's Material Supply Company Inc, or a designated Cal Spas representative. This Limited Warranty is void if damage occurs to the spa shell because of excessive heat buildup due to failure to cover a spa that is empty of water while exposed to direct sunlight.

#### **Proration of Warranty**

Units determined by the Manufacture to be non-repairable will be replaced on a prorated basis with the same or a comparable unit. The owner will be charged 1% of the current retail cost for each full month of ownership from the date of purchase through the date failure is determined to be non-repairable. This charge will be waived during the first 6 months of ownership. **[example]:** Product failure is determined during seven months of ownership. owner will be responsible to pay for 7% of the products current cost.

#### **Limitations**

The manufacture disclaims all warranties, expressed or implies, in fact or in law, to the extent allowed by your State's law, including the warranty of merchantability and fitness for use, except as stated specifically herein. All warranty service must be performed by the manufacture or its designated representative using authorized Cal Spas parts. No agent, dealer, distributor, service company, or other party is authorized to change, modify, or extend the terms of this limited warranty in any manner whatsoever. The manufacture will not be responsible for any statements or representations made in any form that go beyond, are broader than, or are inconsistent with any authorized literature or specifications furnished by Cal Spas.

#### **Disclaimers**

Lloyd's Material Supply Company, Inc., Manufacture of Cal Spas brand and its representatives shall not be liable for any injury, loss, cost, or other damage whether incidental or consequential, arising out of any defect covered by this limited warranty, including without limitation, loss of use of the spa and cost for removal of defective produce even if the manufacture was advised of the possibility of damage. The liability of the manufacture under this limited warranty, if any shall not exceed the original amount paid for the defective product. Coverage under this limited warranty shall commence as of the original date of delivery and the duration of such coverage shall not extend for any reason whatsoever beyond the states time periods. These disclaimers shall be equally applicable to any service provided by the manufacture and its designated representatives.

#### **Legal Rights**

This limited warranty give you specific legal rights. You may also have other rights that vary from state to state. Some states do not allow limitations on how long an implied warranty lasts, so this limitation may not apply to you.









**CONTACT INFORMATION**

For customer service, please contact your authorized dealer immediately. If you need additional information and/or assistance, contact:

**Lloyd's Material Supply Company, Inc.**  
**Customer Service Department**  
**1462 East Ninth Street**  
**Pomona, CA 91766.**

Toll Free: 1-800-CAL-SPAS  
Fax: 1-909-629-3890