

CalSpas®

OWNER'S MANUAL

Special Edition - LESG

2019



2631-16-E

www.calspas.com

Table of Contents

Important Safety Instructions	1	Bather Load	47
Preparing for Your New Portable Spa . 2		Ozonator	47
Pre-Delivery Checklist	2	Troubleshooting Water Clarity Problems . .	48
Planning the Best Location	2	Cleaning and Maintenance Sound System	49
Preparing a Good Foundation	3	Removing and Reseating the Pillows	49
Opening the Front Door Panel for Electrical		Jet Removal and Replacement	49
Hookup	3	Draining Your Portable Spa	50
240 Volt Electrical Installation	4	Winterizing (Cold Climate Draining)	51
Wiring Requirement	5	Cleaning and Replacing the Filter	51
GFCI Wiring Diagram	6	Spa Cover and Locking System	52
120 Volt Electrical Installation	7	Vacation Care	53
Testing the 240 Volt GFCI Breaker	7	Cleaning Your Spa	53
Filling and Powering Up Your Portable Spa	7	Appendix	54
Priming the Pump	10	Replacement Parts	54
Operating Your Spa	11	Basic Troubleshooting	59
TP500 Topside Control Operation	11	"Thermal Creep"	61
Jets	37	Limited Warranty	62
Diverter Knobs	37	Warranty Registration	66
Air Venturis	37		
Water Clarity	38		
Water Quality Terms and Definitions	38		
Water Testing Methods	39		
Adding Chemicals to the Spa Water	40		
1. Balancing the Water Chemistry Levels . 40			
2. Sanitation and Shock	42		
3. Filtration	43		
4. Regularity (Maintenance Schedule)	44		
Generic Names for Chemicals	44		
Common Water Chemistry Questions	45		
Do's and Don'ts	46		

Copyright 2019 LMS. All rights reserved. Duplication without written consent is strictly prohibited.

Cal Spas® and Freedom Sound System™ are registered trademarks.

Due to continuous improvement programs, all models, operation, and/or specifications are subject to change without prior notice.

LTR20191164, Rev. A
11/20/19

CONTACT INFORMATION

For customer service, please contact your authorized dealer immediately. If you need additional information and/or assistance, contact:

LMS Customer Service Department
1462 East Ninth Street
Pomona, CA 91766.

Toll Free: 1-800-CAL-SPAS
Fax: 1-909-629-3890

Important Safety Instructions

READ AND FOLLOW ALL INSTRUCTIONS.

DANGER -- Risk of accidental drowning:

Do not allow children to be in or around a spa unless a responsible adult supervises them. Keep the spa cover on and locked when not in use. See instructions enclosed with your cover for locking procedures.

DANGER -- Risk of injury:

The suction fittings in this spa are sized to match the specific water flow created by the pump. Should the need arise to replace the suction fittings, or the pump, be sure the flow rates are compatible.

Never operate the spa if the suction fitting or filter baskets are broken or missing. Never replace a suction fitting with one that is rated less than the flow rate marked on the original suction fitting.

DANGER -- Risk of electric shock:

Install the spa at least 5 feet (1.5 meters) from all metal surfaces. As an alternative, a spa may be installed within 5 feet of metal surfaces if each metal surface is permanently bonded by a minimum #8 AWG solid copper conductor to the outside of the spa's control box.

Do not permit any external electrical appliances, such as lights, telephones, radios, televisions, and etc., within five feet (1.5 meters) of the spa. Never attempt to operate any electrical device from inside the spa.

Replace a damaged power cord immediately.

Do not bury the power cord.

Connect to a grounded, grounding-type receptacle only.

WARNING -- To reduce the risk of injury:

The spa water should never exceed 104°F (40°C). Water temperatures between 100°F (38°C) and 104°F (40°C) are considered safe for a healthy adult. Lower water temperatures are recommended for young children and when spa use exceeds 10 minutes.

High water temperatures have a high potential for causing fetal damage during pregnancy. Women who are pregnant, or who think they are pregnant, should always check with their physician prior to spa usage.

The use of alcohol, drugs or medication before or during

spa use may lead to unconsciousness, with the possibility of drowning.

Persons suffering from obesity, a medical history of heart disease, low or high blood pressure, circulatory system problems or diabetes should consult a physician before using the spa.

Persons using medications should consult a physician before using the spa since some medications may induce drowsiness while others may affect heart rate, blood pressure and circulation.

HYPERTHERMIA DANGER:

Prolonged exposure to hot air or water can induce hyperthermia. Hyperthermia occurs when the internal temperature of the body reaches a level 3°F to 6°F above the normal body temperature of 98.6°F (or 2°C to 4°C above 37°C). While hyperthermia has many health benefits, it is important not to allow your body's core temperature to rise above 103°F (39.5°C).

Symptoms of excessive hyperthermia include dizziness, lethargy, drowsiness and fainting. The effects of excessive hyperthermia may include:

- Failure to perceive heat
- Failure to recognize the need to exit spa or hot tub
- Unawareness of impending hazard
- Fetal damage in pregnant women
- Physical inability to exit the spa
- Unconsciousness

WARNING: The use of alcohol, drugs, or medication can greatly increase the risk of fatal hyperthermia.

WARNING: People with infectious diseases should not use a spa or hot tub.

WARNING: To avoid injury, exercise care when entering or exiting the spa or hot tub.

WARNING: Do not use drugs or alcohol before or during the use of a spa or hot tub to avoid unconsciousness and possible drowning.

WARNING: Do not use a spa or hot tub immediately following strenuous exercise.

WARNING: Prolonged immersion in a spa or hot tub may be injurious to your health.

CAUTION: Maintain water chemistry in accordance with manufacturer's instructions.

SAVE THESE INSTRUCTIONS.

Preparing for Your New Portable Spa

Pre-Delivery Checklist

Most cities and counties require permits for exterior construction and electrical circuits. In addition, some communities have codes requiring residential barriers such as fencing and/or self-closing gates on property to prevent unsupervised access to the property by children. Your dealer can provide information on which permits may be required and how to obtain them prior to the delivery of your spa.

Before Delivery	
	Plan your delivery route
	Choose a suitable location for the spa
	Lay a 5 - 8 cm concrete slab
	Install dedicated electrical supply
After Delivery	
	Place spa on slab
	Connect electrical components

Planning the Best Location

Safety First

Do not place your spa within 10 feet (3 m) of overhead power lines.

Consider How You Will Use Your Spa

How you intend to use your spa will help you determine where you should position it. For example, will you use your spa for recreational or therapeutic purposes? If your spa is mainly used for family recreation, be sure to leave plenty of room around it for activity. If you will use it for relaxation and therapy, you will probably want to create a specific mood around it.

Plan for Your Environment

If you live in a region where it snows in the winter or rains frequently, place the spa near a house entry. By doing this, you will have a place to change clothes and not be uncomfortable.

Consider Your Privacy

In a cold-weather climate, bare trees won't provide much privacy. Think of your spa's surroundings during all seasons to determine your best privacy options. Consider the view of your neighbors as well when you plan the location of your spa.

Provide a View with Your Spa

Think about the direction you will be facing when sitting in your spa. Do you have a special landscaped area in your yard that you find enjoyable? Perhaps there is an area that catches a soothing breeze during the day or a lovely sunset in the evening.

Keep Your Spa Clean

In planning your spa's location, consider a location where the path to and from the house can be kept clean and free of debris.

Prevent dirt and contaminants from being tracked into your spa by placing a foot mat at the spa's entrance where the bathers can clean their feet before entering your spa.

Allow for Service Access

Make sure the spa is positioned so that access to the equipment compartment and all side panels will not be blocked.

Many people choose to install a decorative structure around their spa. If you are installing your spa with any type of structure on the outside, such as a gazebo, remember to allow access for service. It is always best to design special installations so that the spa can still be moved, or lifted off the ground.

Preparing a Good Foundation

Your spa needs a solid and level foundation. The area that it sits on must be able to support the weight of the spa, with water and the occupants who use it. If the foundation is inadequate, it may shift or settle after the spa is in place, causing stress that could DAMAGE YOUR SPA SHELL AND FINISH.

Damage caused by inadequate or improper foundation support is not covered by the warranty. It is the responsibility of the spa owner to provide a proper foundation for the spa.

Place the spa on an elevated 3 to 4" / 30 cm concrete slab. Pavers, gravel, brick, sand, timbers or dirt foundations are **not** adequate to support the spa.

We strongly recommend that a qualified, licensed contractor prepare the foundation for your spa.

If you are installing the spa indoors, pay close attention to the flooring beneath it. Choose flooring that will not be damaged or stained.

If you are installing your spa on an elevated wood deck or other structure, it is highly recommended that you consult a structural engineer or contractor to ensure the structure will support the weight of 150 pounds per square foot (732 kg / m²).

To properly identify the weight of your new spa when full, remember water weighs 8.33 lbs. per gallon, or 1 kg per liter. For example, an average 8' spa holds approximately 500 gallons, or 1892 liters, of water. Using this formula, you will find that the weight of the water alone is 4,165 lbs, or 1892 kg. Combined with the dry weight of the spa you will note that this spa will weigh approximately 5,000 lbs, or 2267 kg, when full of water.



Opening the Front Door Panel for Electrical Hookup

The following electrical connections must be performed by a licensed electrical contractor. Unscrew and remove the two corner panels on each side of the spa's front door.





Reach in and pull the drain assembly through by a few inches. Carefully unscrew the black outer drain knob and then unscrew and remove the front door panel.

Pictured to the right is the inside of the spa behind the front door. The electrician now has access to connect the spa for power. While the front door is off, refer to page 7 for instructions on ensuring the plumbing fittings are secure (but do not be tempted to over-torque or over-tighten these fittings).



Pull the drain pipe through the front door panel, reattach the black outer drain knob and pull the drain assembly back inside so that the knob is flush with the panel again. Reattach and screw panels back in. (Front door first, then corner panels)

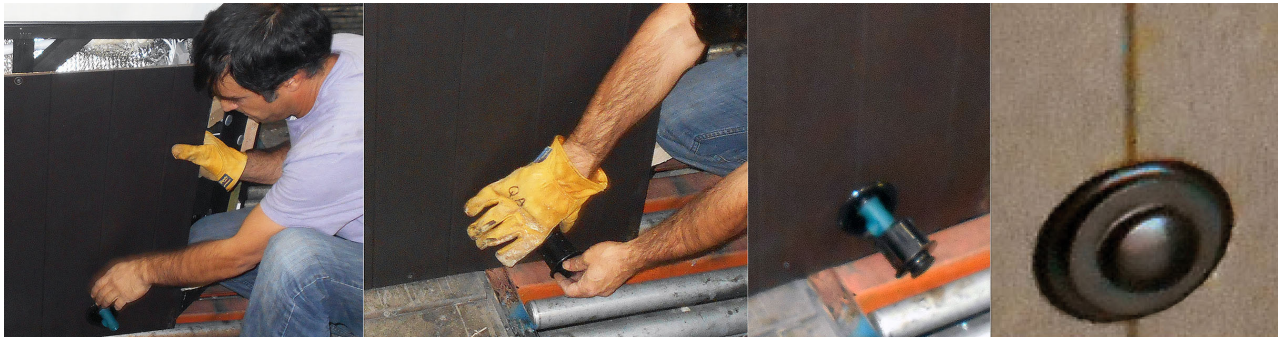

240 Volt Electrical Installation

All 240V spas must be permanently connected (hard wired) to the power supply. See the GFCI and wiring requirements on page 5.

These instructions describe the only acceptable electrical wiring procedure. Spas wired in any other way will void your warranty and may result in serious injury.

When installed in the United States, the electrical wiring of this spa must meet the requirements of NEC 70 and any applicable local, state, and federal codes.

The electrical circuit must be installed by an electrical contractor and approved by a local building or electrical inspector.

Failure to comply with state and local codes may result in fire or personal injury and will be the sole responsibility of the spa owner.

The power supplied to the spa must be on a dedicated GFCI protected circuit as required by NEC 70 with no other appliances or lights sharing the power.

Use copper wire with THHN insulation. Do not use aluminum wire.

Use the table below to determine your GFCI and wiring requirements.

Wires that run over 100 feet must increase wire gauge to the next lower number. For example: A normal 50 amp GFCI with four #6 AWG copper wires that run over 100 feet would require you to go to four #4 AWG copper wires.

Wiring Requirement

Control System	GFCI Required	Wires Required
BP100	One 50 amp GFCI	Four #6 AWG copper wires

GFCI Wiring Diagram

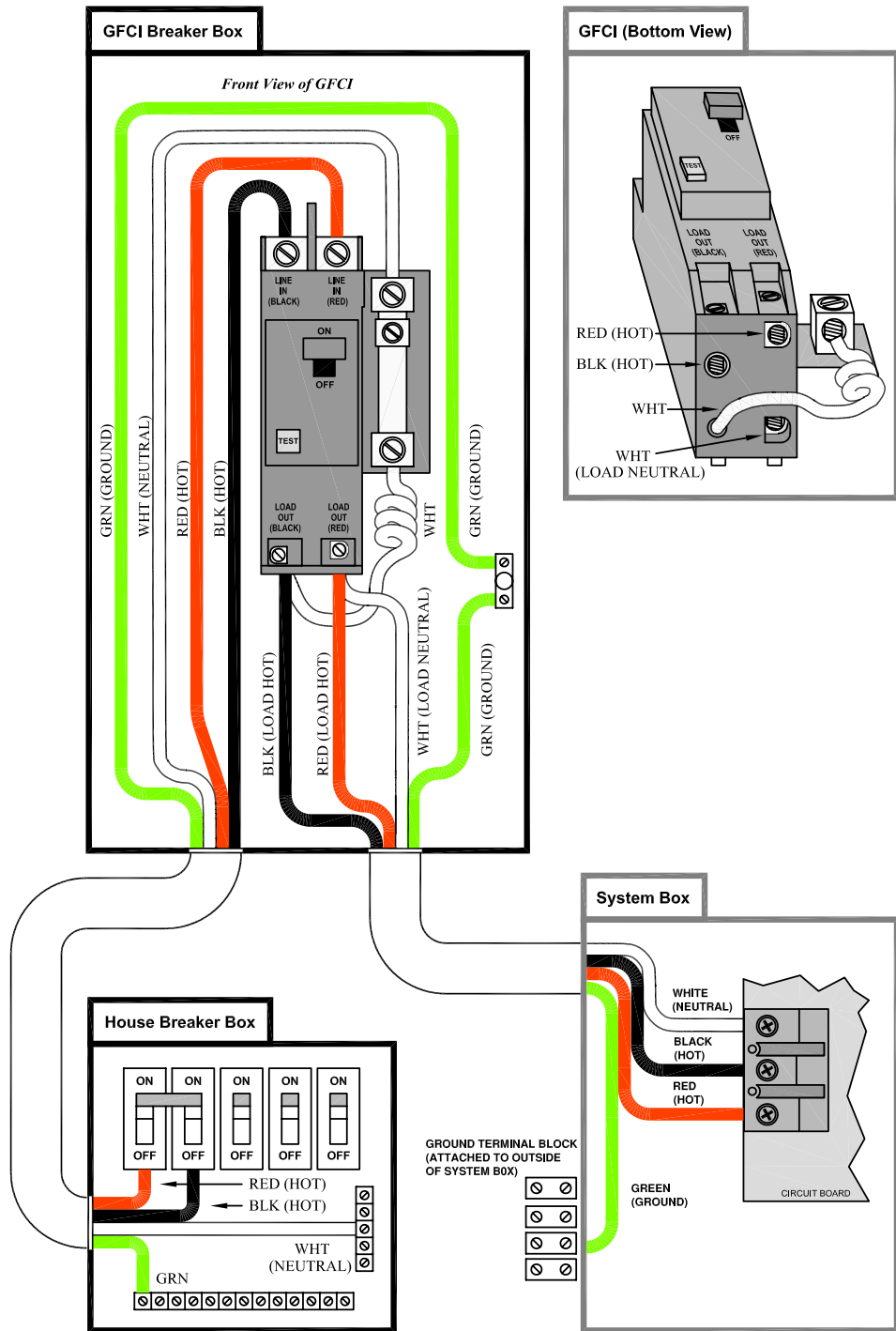

120 Volt Electrical Installation

Always follow applicable local, state and federal codes and guidelines.

Use only a dedicated electrical line with a 15 amp breaker.

Cord-and-plug connections may not use a cord longer than 15 feet (4.6 m) and must be plugged into a dedicated 15 amp GFCI connection (NEC 680.42(A) (2)). Do not use extension cords!

Always use a weatherproof-covered receptacle.

Receptacle shall be located not less than 5 feet (1.5 m) from and not exceeding 10 feet (3.0 m) from the inside wall of the spa. (NEC 680.43(A))

Do not bury the power cord. If your cord becomes damaged, replace it before next usage.

All 120V spas must have a GFCI. This can be either a 15 amp GFCI receptacle or a 15 amp GFCI cord and plug kit as shown (CKIT110 - P/N ELE09700086).

Testing the GFCI plug

Test the GFCI plug prior to first use and periodically when the spa is powered.

1. Plug in the GFCI into the power outlet. The indicator should turn on.
2. Press the TEST button. The GFCI will trip, the indicator will turn off, and the spa will stop operating.
3. Press the RESET button. The GFCI will reset, the indicator will turn on again, and the spa will turn back on.



The spa is now safe to use.

If the GFCI trips while the spa is in use, press the RESET button. If the GFCI does not reset, unplug the spa and call your local Cal Spas dealer for service. DO NOT USE THE SPA!

Testing the 240 Volt GFCI Breaker

Test the GFCI breaker prior to first use and periodically when the spa is powered. To test the GFCI breaker follow these instructions (spa should be operating):

1. Press the TEST button on the GFCI. The GFCI will trip and the spa will shut off.
2. Reset the GFCI breaker by switching the breaker to the full OFF position, wait a moment, then turn the breaker back on. The spa should have power again.

Filling and Powering Up Your Portable Spa

1. Inspect the spa equipment.

Inspect all plumbing connections in the equipment area of your spa.

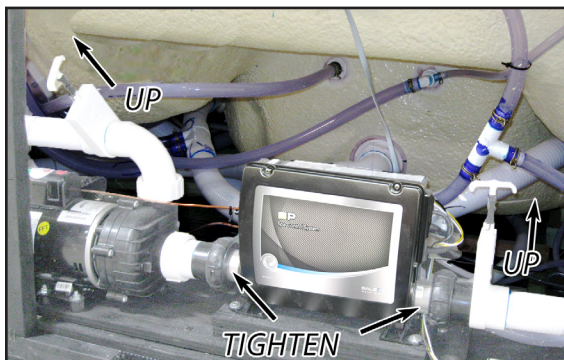

- Make sure unions in the equipment pack are tight. (Be careful not to over-tighten the plumbing fittings.)
- If your spa has gate valves, make sure they are all in the UP or OPEN position.
- Make sure the drain valve is closed and capped. (See page 50 for a description of drain valves.)

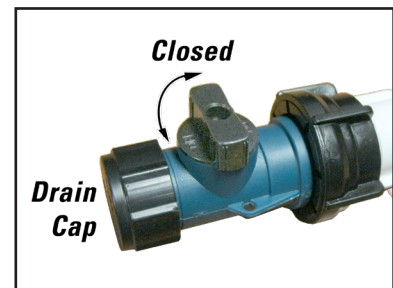

Never run the spa with the gate valves closed or without water circulating for long periods of time.

2. Remove the cartridge from filter canister.

If you have a skimmer like this:

Grip the filter by the handle and unscrew it from the canister. Never try to pull the filter cartridge while the spa is running in low or high speed (i.e., any speed).



If you have a skimmer like this:

Remove the black skimmer cap and barrel, grip the filter by the handle and unscrew it from the canister.



Teleweir Mega filter skimmer

- 75 square feet filtration
- Smooth cap

If you have a skimmer like this:

Rotate and remove the black locking ring. Remove the black skimmer cap and barrel, grip the filter by the handle and unscrew it from the canister.

Replace and lock the locking ring and slide the skimmer cap and barrel back in the canister.

Note: The skimmer cap and barrel were locked in place at the factory to prevent damage during shipment. It must be unlocked and replaced in the filter canister so that it can float when the spa is filled. If you do not remove the cap and barrel, your spa's filtration system will not perform as it was designed to.



Teleweir filter skimmer

- 50 square feet filtration
- Spoked cap



After you remove the filter, remove the plastic wrapper and soak it in water for 30 minutes before you replace it. A dry filter can allow air into the filtration system which can cause the pump to fail to prime.

3. Fill the spa.

Place a garden hose in the filter canister and fill your spa.

Always fill the spa through the filter canister. Failure to do so may cause air to be trapped in the filtration system and prevent the pumps from operating properly.



Fill the spa until water level is about six inches from the top.

If the water level is too low or too high, your spa will not operate properly.

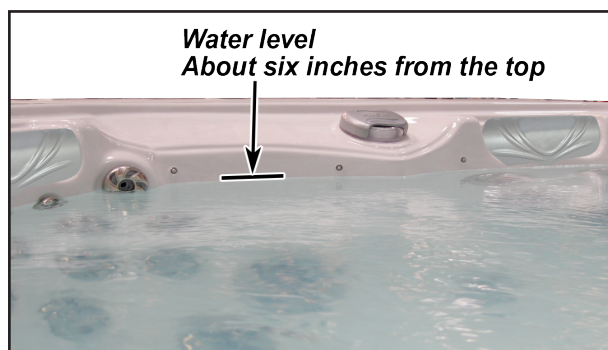

Never fill your spa with soft water.

Soft water makes it impossible to maintain the proper water chemistry and may cause the water to foam, which will ultimately harm the finish of the spa and void your warranty. You may fill your spa with **well water**

provided the following conditions are met: 1) Purchase and use a pre-filter to run the well water through on the fill-up. The pre-filter will be placed before the spa filter in the fill-up flow of water. 2) Have a Total Dissolved Solids (TDS) and metals test performed by a qualified person after the fill-up process but before any spa use.

4. Turn on power to the spa.



When the spa is filled to the correct level, turn on the power at the GFCI breaker. (Ensure that the 120V spas are connected to the proper electrical outlet.)

5. Prime the pump.



For **TP500**. Your spa will perform a self-diagnostic check and go into Priming Mode. The control panel will display either **RUN PUMPS PURG AIR ---** or **Priming Mode**, depending on which control panel you have.

Do the following:

1. Press the JETS button once to start the pump in low speed.
2. Press it again to switch the pump to high speed.
3. If you have other pumps, press AUX to turn them on also.

Running the pumps helps the pumps prime.

After two minutes, the pump should prime. If it does not, follow the priming instructions on the next page. If it does, continue with the next step.

6. Install the filter into the filter canister.



Make sure the filter has soaked at least 30 minutes before you install it. Insert the filter all the way and screw it in. Do not over-torque the cartridge during installation, just hand tighten gently.



7. Adjust water chemistry.

Test and adjust the water chemistry. See the section on page 38 for instructions on keeping your water clear.

8. Let the spa heat up.

When the spa has finished priming, the heater will activate. Put the cover on and let the spa heat to the set temperature.

Priming the Pump

New spa owners often have difficulty the first time they start their spa and the pump fails to prime. This can be frustrating, but these simple instructions can help you.

Sometimes air can become trapped in the pump while filling the spa. You will know this has happened when after you have filled and started the spa, the pump does not seem to function. You will hear the pump operating, but no water will be moving.

There are two methods of priming the pump.

The first method will remove small air bubbles trapped in the pump.

1. Turn the spa on and wait for PR (Priming Mode) to appear on the topside display.
2. Press the JETS 1 button to turn on the pump and let it run for 10 seconds. The pump should be running in low speed.
3. Press the JETS 1 buttons again and let the pump run in high speed for 10 seconds.
4. Press the JETS 1 button again to turn off the pump. The pump should be left in the off position for 10 to 15 seconds.
5. Repeat steps 1 through 4 until water is flowing through all the jets and all air is removed from the plumbing.

The second method will remove a large air lock within the pump.

1. Using a Phillips screwdriver, remove the front panel from the spa and locate the pump.
2. While the spa is operating, turn the bleeder valve counter clockwise with a small pair of pliers or a flat head screwdriver until the air has been released from the pump.
3. If this is unsuccessful, loosen the white union nut on side of the pump with channel locks. When air is bled out, tighten the nut and set the pump on high speed.



The pump will not work properly while air is trapped in it. Continuing to operate the pump in this way will cause damage.

Whenever you fill your spa, fill it through the filter canister and make sure all jets are open.

Note: If you press the **Temp** button any time during Priming Mode, it will exit that mode and begin Standard Mode.

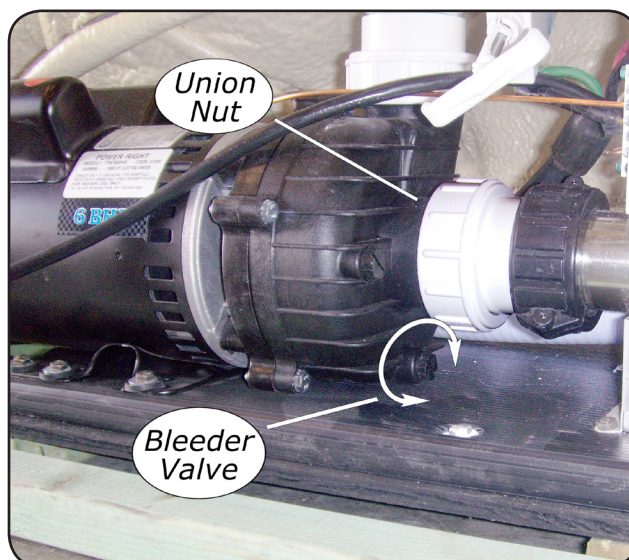

TP500 Topside Control Operation

Two-pump System

TP500 Control Panel

User Guide for Standard Menu

System Model: All BP series systems
 Panel Model: TP500 and TP500S Series
 Panel Software Version: All versions



Display Icons



- | | | |
|-----------------------------|-------------------|--------------------------------------|
| A - Heat | F - Light | K - Auxiliary (Jets 3 or MICROSilk™) |
| B - Ready Mode | G - Cleanup Cycle | L - Temperature Range (High / Low) |
| C - Rest Mode | H - Jets 1 | M - Set (Programming) |
| D - bba™ 2 On | I - Jets 2 | N - Filter Cycle (1 or 2 or Both) |
| E - WiFi (Cloud Connection) | J - Blower | O - AM or PM (Time) |

MicroSilk™ is a registered trademark of Jason International.

Manufactured under one or more of these patents. U.S. Patents: 5332944, 5361215, 5550753, 5559720, 5,883,459, 6253227, 6282370, 6590188, 6976052, 6965815, 7030343, 7,417,834 b2, Canadian Patent: 2342614, Australian patent: 2373248 other patents both foreign and domestic applied for and pending.

Main Menu

Navigation

Navigating the entire menu structure is done with 2 or 3 buttons on the control panel.



Some panels have separate **WARM** (Up) and **COOL** (Down) buttons, while others have a single **Temperature** button. In the navigation diagrams Temperature buttons are indicated by a single button icon. Panels that have two Temperature buttons (Warm and Cool) can use both of them to simplify navigation and programming where a single Temperature icon is shown.

The **MENU/SELECT** Button is used to choose the various menus and navigate each section.

Typical use of the Temperature button(s) allows changing the Set Temperature while the numbers are flashing in the LCD. The menus can be exited with certain button presses. Simply waiting for a few seconds will return the panel operation to normal.

Key

- Indicates Flashing or Changing Segment
- Indicates Alternating or Progressive Message - every 1/2 second
- ↕ A temperature button, used for "Action"
- ≡ Menu/Select button
- Waiting time that keeps the last change to a menu item.
- * * * * * Waiting time (depends on menu item) that reverts to original setting and ignores any change to that menu item.

Power-up Screens

Each time the System powers up, a series of numbers is displayed. After the startup sequence of numbers, the system will enter Priming Mode (See Page 3).

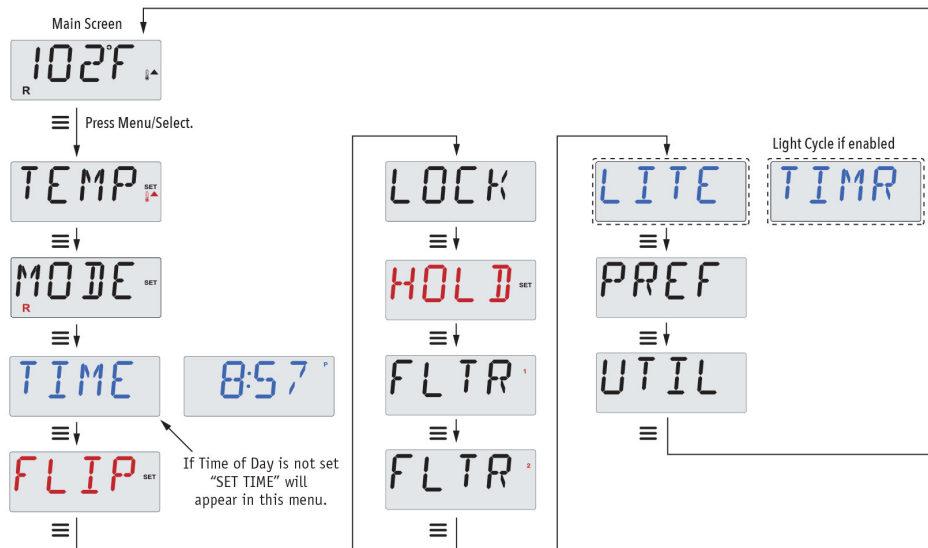

Indicates a Menu Item that Depends on a Manufacturer Configuration and may or may not appear.

Main Screen
102°F

Waiting a few seconds in the Main Menu will allow the display to revert to the Main Screen. Most changes are not saved unless Menu/Select ≡ is pressed. Refer to key above.

Manufactured under one or more of these patents. U.S. Patents: 5332944, 5361215, 5550753, 5559720, 5,883,459, 6253227, 6282370, 6590188, 6976052, 6965815, 7030343, 7,417,834 b2, Canadian Patent: 2342614, Australian patent: 2373248 other patents both foreign and domestic applied for and pending.

Fill it up!

Preparation and Filling

Fill the spa to its correct operating level. Be sure to open all valves and jets in the plumbing system before filling to allow as much air as possible to escape from the plumbing and the control system during the filling process.

After turning the power on at the main power panel, the top-side panel display will go through specific sequences. These sequences are normal and display a variety of information regarding the configuration of the hot tub control.

Priming Mode - M019*

This mode will last for 4-5 minutes or you can manually exit the priming mode after the pump(s) have primed.



Regardless of whether the priming mode ends automatically or you manually exit the priming mode, the system will automatically start normal heating and filtering at the end of the priming mode. During the priming mode, the heater is disabled to allow the priming process to be completed without the possibility of energizing the heater under low-flow or no-flow conditions. Nothing comes on automatically, but the pump(s) can be energized by pushing the "Jets" or "Aux" buttons.

If the spa has a Circ Pump, it can be activated by pressing the "Light" button during Priming Mode.

Priming the Pumps

As soon as the above display appears on the panel, push the "Jets" button once to start Pump 1 in low-speed and then again to switch to high-speed. Also, push the "Jets 2" or "Aux" button, if you have a 2nd pump, to turn it on. The pumps will now be running in high-speed to facilitate priming. If the pumps have not primed after 2 minutes, and water is not flowing from the jets in the spa, do not allow the pumps to continue to run. Turn off the pumps and repeat the process. Note: Turning the power off and back on again will initiate a new pump priming session. Sometimes momentarily turning the pump off and on will help it to prime. Do not do this more than 5 times. If the pump(s) will not prime, shut off the power to the spa and call for service.

Important: A pump should not be allowed to run without priming for more than 2 minutes. Under NO circumstances should a pump be allowed to run without priming beyond the end of the 4-5 minute priming mode. Doing so may cause damage to the pump and cause the system to energize the heater and go into an overheat condition.

Exiting Priming Mode

You can manually exit Priming Mode by pressing the "Warm" or "Cool" button. Note that if you do not manually exit the priming mode as described above, the priming mode will be automatically terminated after 4-5 minutes. Be sure that the pump(s) have been primed by this time.

Once the system has exited Priming Mode, the top-side panel will momentarily display the set temperature but the display will not show the water temperature yet, as shown below.



This is because the system requires approximately 1 minute of water flowing through the heater to determine the water temperature and display it.

*M019 is a Message Code. See Page 18.

Manufactured under one or more of these patents. U.S. Patents: 5332944, 5361215, 5550753, 5559720, 5,883,459, 6253227, 6282370, 6590188, 6976052, 6965815, 7030343, 7,417,834 b2, Canadian Patent: 2342614, Australian patent: 2373248 other patents both foreign and domestic applied for and pending.

Spa Behavior

Pumps

Press the “Jets” button once to turn pump 1 on or off, and to shift between low and high speeds if equipped. If left running, the pump will turn off after a time-out period.

On non-circ systems, the low-speed of pump 1 runs when the blower or any other pump is on. If the spa is in Ready Mode (See page 6), Pump 1 low may also activate once in a while for at least 1 minute to detect the spa temperature (polling) and then to heat to the set temperature if needed. When the low-speed turns on automatically, it cannot be deactivated from the panel, however the high speed may be started.

Circulation Pump Modes

If the system is equipped with a circ pump, it will be configured to work in one of three different ways:

- 1, The circ pump operates continuously (24 hours) with the exception of turning off for 30 minutes at a time when the water temperature reaches 3°F (1.5°C) above the set temperature (most likely to happen in very hot climates).
- 2, The circ pump stays on continuously, regardless of water temperature.
- 3, A programmable circ pump will come on when the system is checking temperature (polling), during filter cycles, during freeze conditions, or when another pump or blower is on.

The specific Circulation Mode that is used has been determined by the Manufacturer and cannot be changed in the field.

Filtration and Ozone

On non-circ systems, Pump 1 low and the ozone generator will run during filtration. On circ systems, the ozone will run with the circ pump.

The system is factory-programmed with one filter cycle that will run in the evening (assuming the time-of-day is properly set) when energy rates are often lower. The filter time and duration are programmable. (See page 10) A second filter cycle can be enabled as needed.

At the start of each filter cycle, all water devices (other than the primary pump) will run briefly to purge the plumbing to maintain good water quality. The term “water devices” includes the Blower.

Freeze Protection

If the temperature sensors within the heater detect a low enough temperature, then the pump(s) and the blower automatically activate to provide freeze protection. The pump(s) and blower will run either continuously or periodically depending on conditions.

In colder climates, an optional freeze sensor may be added to protect against freeze conditions that may not be sensed by the standard sensors. Auxiliary freeze sensor protection acts similarly except with the temperature thresholds determined by the switch. See your dealer for details.

Clean-up Cycle (optional)

When a pump or blower is turned on by a button press, a clean-up cycle begins 30 minutes after the pump or blower is turned off or times out. The pump and the ozone generator will run for 30 minutes or more, depending on the system. On some systems, you can change this setting. (See the Preferences section on page 12)

Manufactured under one or more of these patents. U.S. Patents: 5332944, 5361215, 5550753, 5559720, 5,883,459, 6253227, 6282370, 6590188, 6976052, 6965815, 7030343, 7,417,834 b2, Canadian Patent: 2342614, Australian patent: 2373248 other patents both foreign and domestic applied for and pending.

Temperature and Temp Range

Adjusting the Set Temperature

When using a panel with Up and Down buttons (Temperature buttons), pressing Up or Down will cause the temperature to flash. Pressing a temperature button again will adjust the set temperature in the direction indicated on the button. When the LCD stops flashing, the spa will heat to the new set temperature when required.

If the panel has a single temperature button, pressing the button will cause the temperature to flash. Pressing the button again will cause the temperature to change in one direction (e.g. UP). After allowing the display to stop flashing, pressing the Temperature Button will cause the temperature to flash and the next press will change the temperature in the opposite direction (e.g. DOWN).

Press-and-Hold

If a Temperature button is pressed and held when the temperature is flashing, the temperature will continue to change until the button is released. If only one temperature button is available and the limit of the Temperature Range is reached when the button is being held, the progression will reverse direction.

Dual Temperature Ranges

This system incorporates two temperature range settings with independent set temperatures. The High Range designated in the display by a thermometer and an "up" arrow, and the Low Range designated in the display by a thermometer and "down" arrow.

These ranges can be used for various reasons, with a common use being a "ready to use" setting vs. a "vacation" setting. The Ranges are chosen using the menu structure below. Each range maintains its own set temperature as programmed by the user. This way, when a range is chosen, the spa will heat to the set temperature associated with that range.

For example:

High Range might be set between 80°F and 104°F.

Low Range might be set between 50°F and 99°F.

More specific Temp Ranges may be determined by the Manufacturer.

Freeze Protection is active in either range.

See Ready and Rest on Page 6 for additional heating control information.

Key

- █ Indicates Flashing or Changing Segment
- █ Indicates Alternating or Progressive Message - every 1/2 second
- A temperature button, used for "Action"
- Menu/Select button
- Waiting time that keeps the last change to a menu item.
- * * * * * Waiting time (depends on menu item) that reverts to original setting and ignores any change to that menu item.

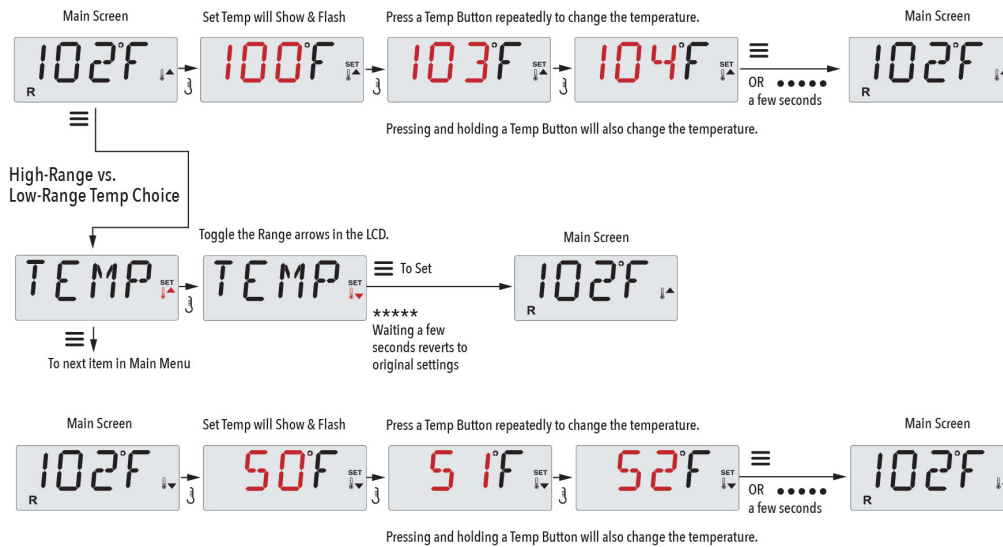

Manufactured under one or more of these patents. U.S. Patents: 5332944, 5361215, 5550753, 5559720, 5,883,459, 6253227, 6282370, 6590188, 6976052, 6965815, 7030343, 7,417,834 b2, Canadian Patent: 2342614, Australian patent: 2373248 other patents both foreign and domestic applied for and pending.

Mode – Ready and Rest

In order for the spa to heat, a pump needs to circulate water through the heater. The pump that performs this function is known as the “primary pump.”

The primary pump can be either a 2-Speed Pump 1 or a circulation pump.

If the primary pump is a 2-Speed Pump 1, Ready Mode (indicated by **R**) will circulate water periodically, using Pump 1 Low, in order to maintain a constant water temperature, heat as needed, and refresh the temperature display. This is known as “polling.”

Rest Mode (indicated by **Ⓡ**) will only allow heating during programmed filter cycles. Since polling does not occur, the temperature display may not show a current temperature until the primary pump has been running for a minute or two.

Circulation Mode (See Page 4, under Pumps, for other circulation modes)

If the spa is configured for 24HR circulation, the primary pump generally runs continuously. Since the primary pump is always running, the spa will maintain set temperature and heat as needed in Ready Mode, without polling.

In Rest Mode, the spa will only heat to set temperature during programmed filter times, even though the water is being filtered constantly when in Circulation Mode.

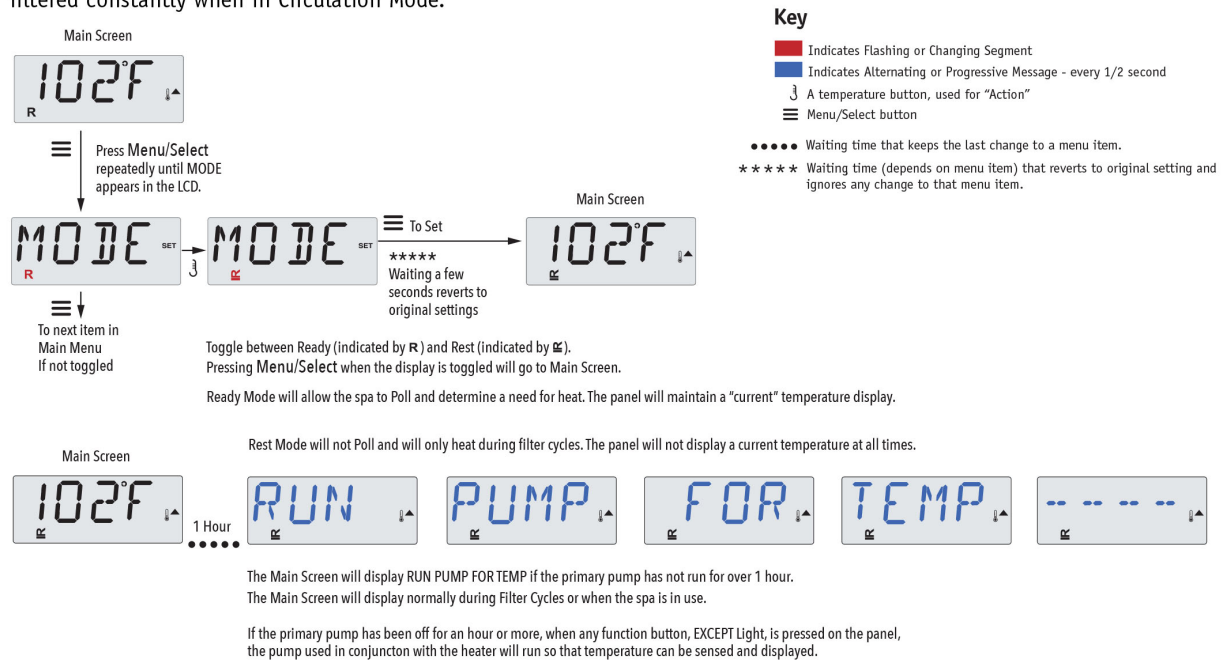

Ready-in-Rest Mode

RⓇ appears in the display if the spa is in Rest Mode and “Jets” is pressed. It is assumed that the spa is being used and will heat to set temperature. The primary pump will run until set temperature is reached, or 1 hour has passed. After 1 hour, the System will revert to Rest Mode. This mode can also be reset by entering the Mode Menu and changing the Mode.

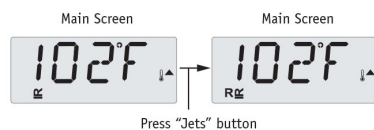

Manufactured under one or more of these patents. U.S. Patents: 5332944, 5361215, 5550753, 5559720, 5,883,459, 6253227, 6282370, 6590188, 6976052, 6965815, 7030343, 7,417,834 b2, Canadian Patent: 2342614, Australian patent: 2373248 other patents both foreign and domestic applied for and pending.

Show and Set Time-of-Day

Be sure to set the Time-of-Day

Setting the time-of-day can be important for determining filtration times and other background features.

When in the TIME menu, SET TIME will flash on the display if no time-of-day is set in the memory.

24-hour time display can be set under the PREF menu. (See Page 12)

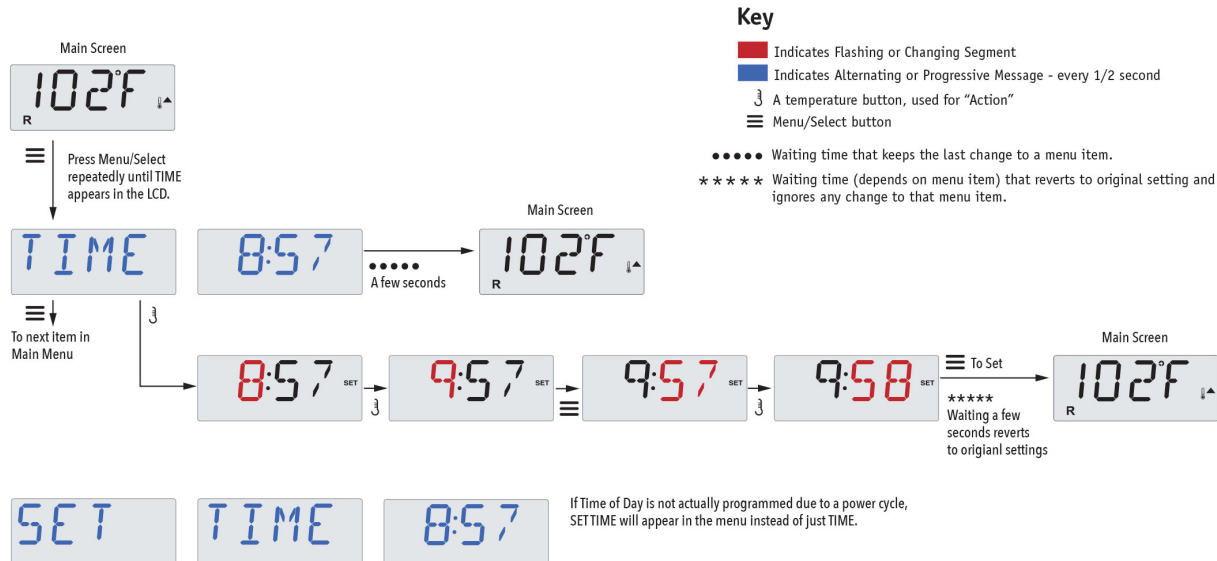

Note:

This note refers to systems that do not keep track of Time-of-Day when powered down.

If power is interrupted to such a system, Time-of-Day is not stored. The system will still operate and all other user settings will be stored. If filter cycles are required to run at a particular time of day, resetting the clock will return the filter times to the actual programmed periods.

When such a system starts up, it defaults to 12:00 Noon, so another way to get filter times back to normal is to start up the spa at noon on any given day. SET TIME will still flash in the TIME Menu until the time is actually set, but since the spa started at noon, the filter cycles will run as programmed.

Flip (Invert Display)

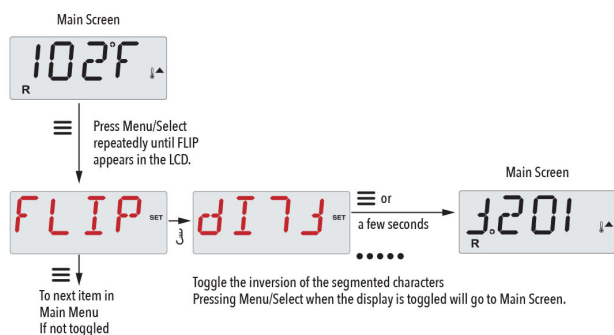

Manufactured under one or more of these patents. U.S. Patents: 5332944, 5361215, 5550753, 5559720, 5,883,459, 6253227, 6282370, 6590188, 6976052, 6965815, 7030343, 7,417,834 b2, Canadian Patent: 2342614, Australian patent: 2373248 other patents both foreign and domestic applied for and pending.

Restricting Operation

The control can be restricted to prevent unwanted use or temperature adjustments.

Locking the panel prevents the controller from being used, but all automatic functions are still active.

Locking the Temperature allows Jets and other features to be used, but the Set Temperature and other programmed settings cannot be adjusted.

Temperature Lock allows access to a reduced selection of menu items.

These include Set Temperature, FLIP, LOCK, UTIL, INFO and FALT LOG.

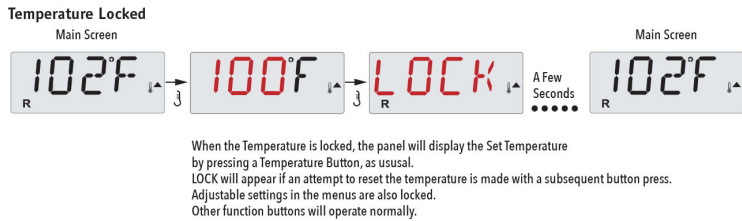
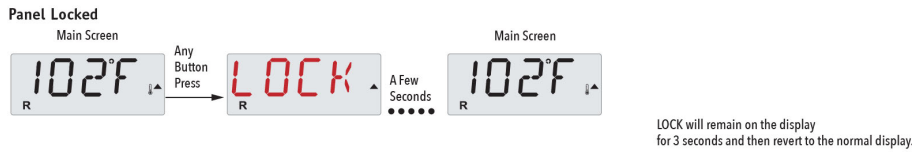
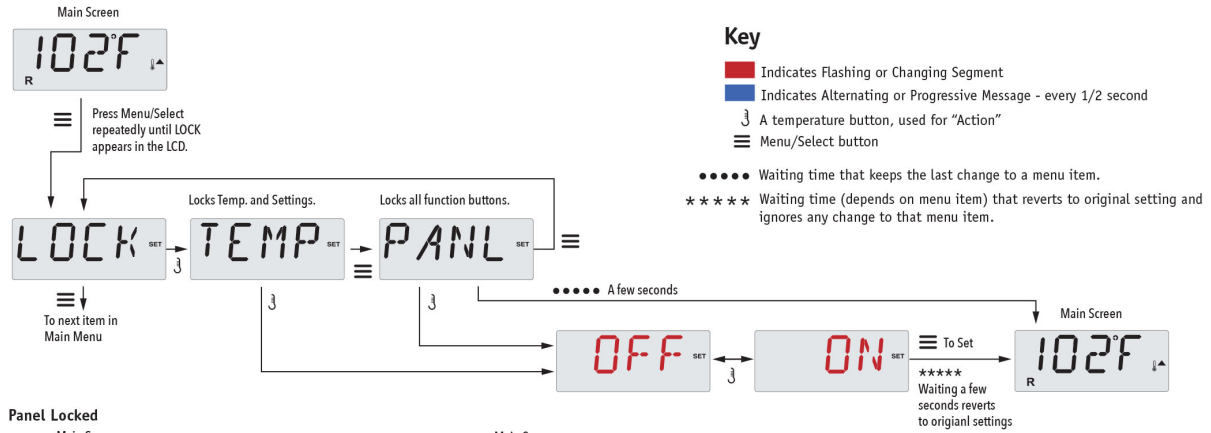

Unlocking

This Unlock sequence may be used from any screen that may be displayed on a restricted panel.

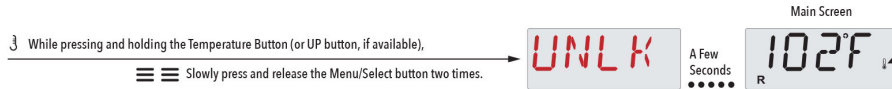

NOTE: If the panel has both an UP and a Down button, the ONLY button that will work in the Unlock Sequence is the UP button.

The temperature will not Unlock if the Unlock sequence is done while the panel is displaying "LOCK".

Manufactured under one or more of these patents. U.S. Patents: 5332944, 5361215, 5550753, 5559720, 5,883,459, 6253227, 6282370, 6590188, 6976052, 6965815, 7030343, 7,417,834 b2, Canadian Patent: 2342614, Australian patent: 2373248 other patents both foreign and domestic applied for and pending.

Hold (Standby)

Hold Mode –M037*

Hold Mode is used to disable the pumps during service functions like cleaning or replacing the filter. Hold Mode will last for 1 hour unless the mode is exited manually.

Drain Mode

Some spas have a special feature that allows a pump to be employed when draining the water. When available, this feature is a component of Hold Mode. Drain Mode will time out with Hold Mode.

Key

- Indicates Flashing or Changing Segment
- Indicates Alternating or Progressive Message - every 1/2 second
- ⏏ A temperature button, used for "Action"
- ☰ Menu/Select button
- Waiting time that keeps the last change to a menu item.
- ***** Waiting time (depends on menu item) that reverts to original setting and ignores any change to that menu item.



M037 is a Message Code. See Page 18.

Manufactured under one or more of these patents. U.S. Patents: 5332944, 5361215, 5550753, 5559720, 5,883,459, 6253227, 6282370, 6590188, 6976052, 6965815, 7030343, 7,417,834 b2, Canadian Patent: 2342614, Australian patent: 2373248 other patents both foreign and domestic applied for and pending.

Adjusting Filtration

Main Filtration

Filter cycles are set using a start time and a duration. Start time is indicated by an "A" or "P" in the bottom right corner of the display. Duration has no "A" or "P" indication. Each setting can be adjusted in 15-minute increments. The panel calculates the end time and displays it automatically.

Key

- Indicates Flashing or Changing Segment
- Indicates Alternating or Progressive Message - every 1/2 second
- ⌋ A temperature button, used for "Action"
- ☰ Menu/Select button
- Waiting time that keeps the last change to a menu item.
- ***** Waiting time (depends on menu item) that reverts to original setting and ignores any change to that menu item.

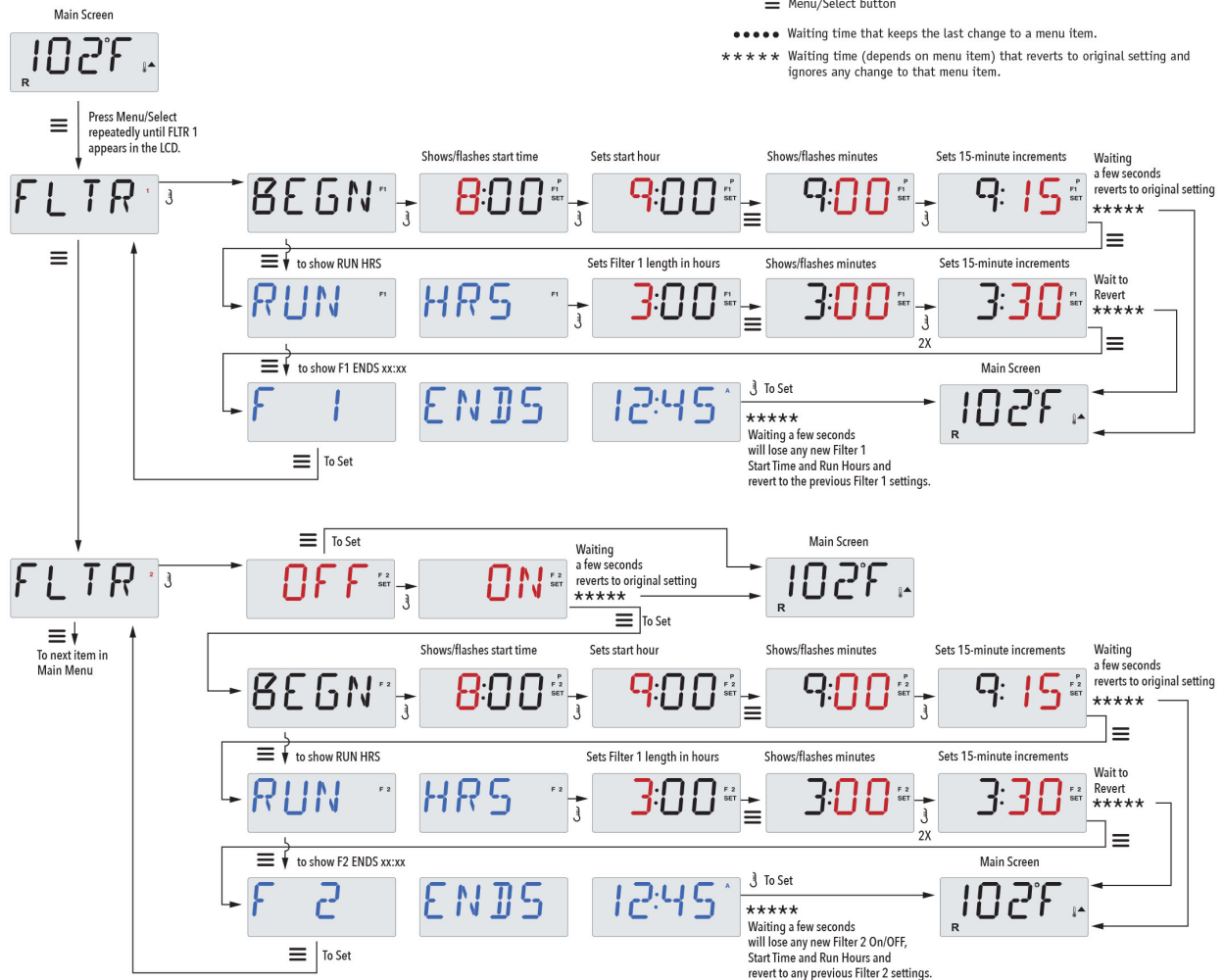

Filter Cycle 2 - Optional Filtration

Filter Cycle 2 is OFF by default.

It is possible to overlap Filter Cycle 1 and Filter Cycle 2, which will shorten overall filtration by the overlap amount.

Purge Cycles

In order to maintain sanitary conditions, secondary Pumps and/or a Blower will purge water from their respective plumbing by running briefly at the beginning of each filter cycle.

If Filter Cycle 1 is set for 24 hours, enabling Filter Cycle 2 will initiate a purge when Filter Cycle 2 is programmed to begin.

Manufactured under one or more of these patents. U.S. Patents: 5332944, 5361215, 5550753, 5559720, 5,883,459, 6253227, 6282370, 6590188, 6976052, 6965815, 7030343, 7,417,834 b2, Canadian Patent: 2342614, Australian patent: 2373248 other patents both foreign and domestic applied for and pending.

Light Timer Programming

Light Timer Option

If LITE TIMR does not appear in the Main Menu, the Light Timer feature is not enabled by the manufacturer.

When available, the Light Timer is OFF by default.

- Key**
- Indicates Flashing or Changing Segment
 - Indicates Alternating or Progressive Message - every 1/2 second
 - ⏏ A temperature button, used for "Action"
 - ☰ Menu/Select button
 - Waiting time that keeps the last change to a menu item.
 - ***** Waiting time (depends on menu item) that reverts to original setting and ignores any change to that menu item.

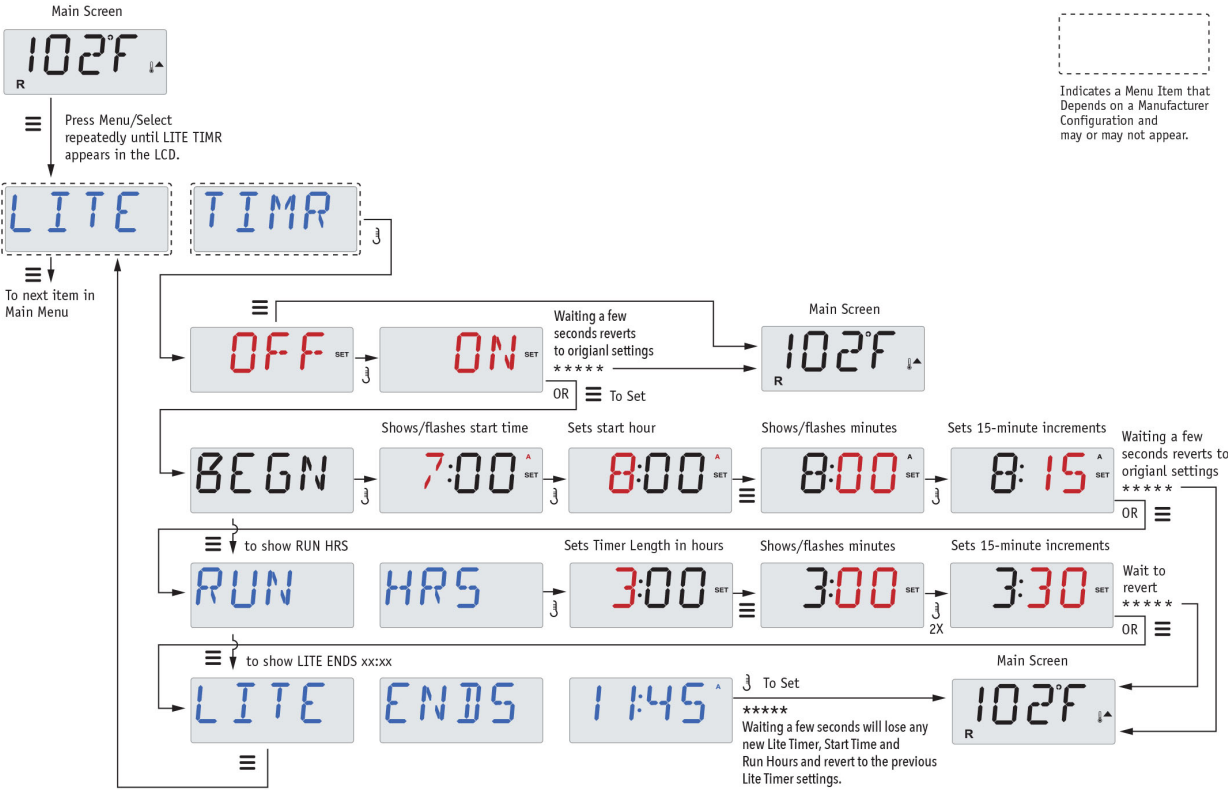

Manufactured under one or more of these patents. U.S. Patents: 5332944, 5361215, 5550753, 5559720, 5,883,459, 6253227, 6282370, 6590188, 6976052, 6965815, 7030343, 7,417,834 b2, Canadian Patent: 2342614, Australian patent: 2373248 other patents both foreign and domestic applied for and pending.

Preferences

F / C (Temp Display)

Change the temperature between Fahrenheit and Celsius.

12 / 24 (Time Display)

Change the clock between 12 hr and 24 hr display.

RE-MIN-DERS (Reminders)

Turn the display of reminder messages (like "Clean Filter") On or Off.

Note: Reminders continue to run in the background even when not displayed. So turning the display of Reminders On or Off does not reset any Reminder counts.

CLN-UP (Cleanup)

Cleanup Cycle Duration is not always enabled, so it may not appear. When it is available, set the length of time Pump 1 will run after each use. 0-4 hours are available.

M8

(This message may not appear on all systems.) On systems that have M8, it is enabled by default. It can be disabled (or re-enabled) here. M8 reduces polling intervals when the water temperature in the spa is steady.

DOL-PHIN-AD-DRES (Dolphin II and Dolphin III) **Applies to RF Dolphin only.** **(This message may not appear depending on the configuration)**

When set to 0, no addressing is used. Use this setting for a Dolphin Remote which is factory set for no address by default. When set between 1 and 7, the number is the address. (See the Dolphin manual for details.)

Manufactured under one or more of these patents. U.S. Patents: 5332944, 5361215, 5550753, 5559720, 5,883,459, 6253227, 6282370, 6590188, 6976052, 6965815, 7030343, 7,417,834 b2, Canadian Patent: 2342614, Australian patent: 2373248 other patents both foreign and domestic applied for and pending.

Preferences

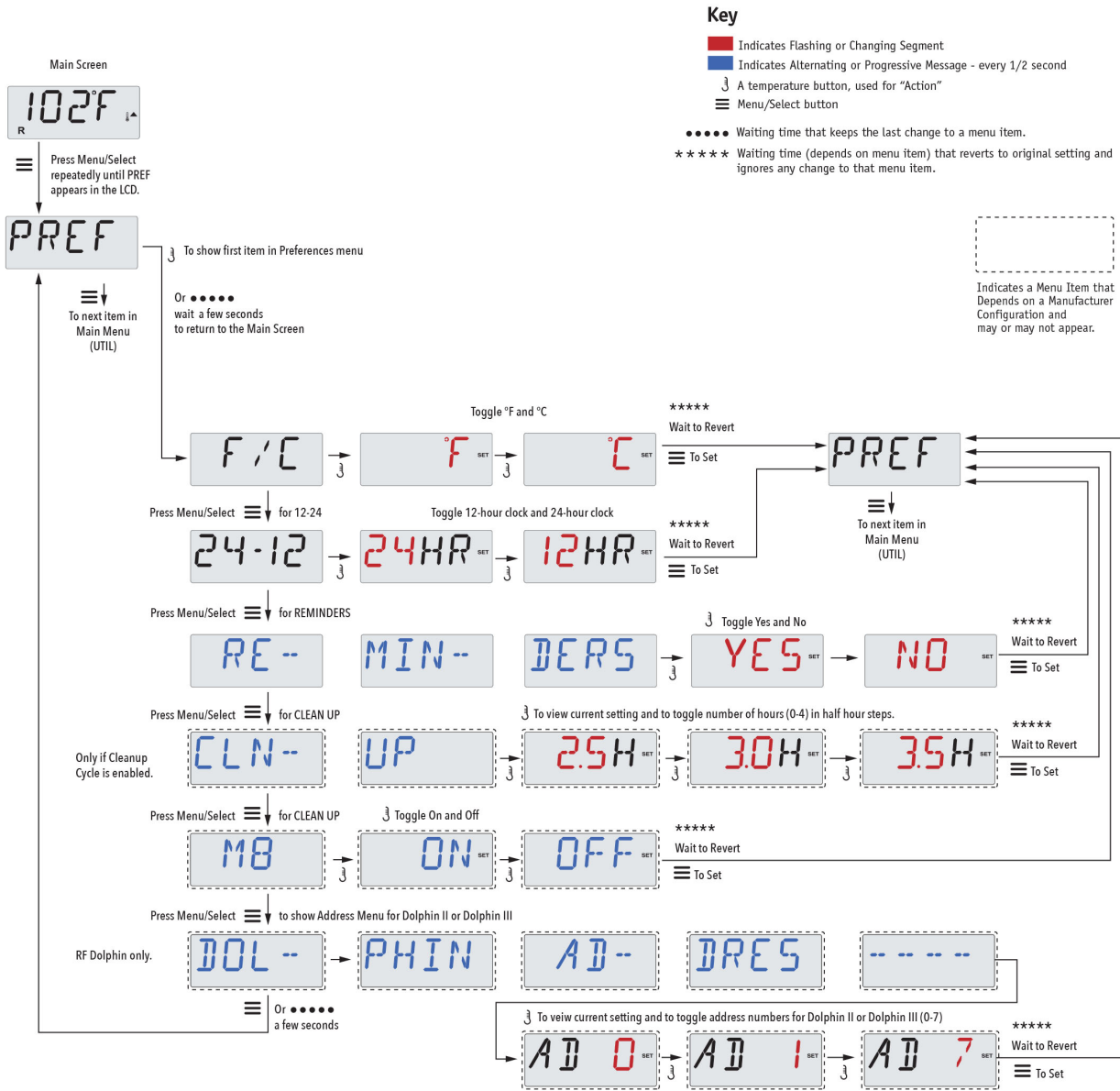

Manufactured under one or more of these patents. U.S. Patents: 5332944, 5361215, 5550753, 5559720, 5,883,459, 6253227, 6282370, 6590188, 6976052, 6965815, 7030343, 7,417,834 b2, Canadian Patent: 2342614, Australian patent: 2373248 other patents both foreign and domestic applied for and pending.

Utilities and Information

INFO (System Information sub-menu)

The System Information Menu displays various settings and identification of the particular system.

SSID (Software ID)

Displays the software ID number for the System.

MODL (System Model)

Displays the Model Number of the System.

SETP (Current Setup)

Displays the currently selected Configuration Setup Number.

Heater Voltage (Feature not used on CE rated systems.)

Displays the operating voltage configured for the heater.

Heater Wattage as Configured in Software (CE Systems Only.)

Displays a heater kilowatt rating as programmed into the control system software (1-3 or 3-6).

H_ (Heater Type)

Displays a heater type ID number.

SW_ (Dip Switch Settings)

Displays a number that represents the DIP switch positions of S1 on the main circuit board.

PANL (Panel Version)

Displays a number of the software in the topside control panel.

Manufactured under one or more of these patents. U.S. Patents: 5332944, 5361215, 5550753, 5559720, 5,883,459, 6253227, 6282370, 6590188, 6976052, 6965815, 7030343, 7,417,834 b2, Canadian Patent: 2342614, Australian patent: 2373248 other patents both foreign and domestic applied for and pending.

Additional Utilities

Utilities

In addition to INFO, The Utilities Menu contains the following:

GFCI (GFCI Test) (Feature not available on CE rated systems.)

GFCI Test is not always enabled, so it may not appear. This screen allows the GFCI to be tested manually from the panel and can be used to reset the automatic test feature. If the GFCI Test Feature is reset, the device will trip within 7 days. (See Page 17)

A / B (A/B Sensor Temperatures)

When this is set to On, the temperature display will alternate to display temperature from Sensor A and Sensor B in the heater.

FALT LOG (Fault Log)

The Fault Log is a record of the last 24 faults that can be reviewed by a service tech.

DEMO (Demo Mode)

Demo Mode is not always enabled, so it may not appear. This is designed to operate several devices in a sequence in order to demonstrate the various features of a particular hot tub.

Manufactured under one or more of these patents. U.S. Patents: 5332944, 5361215, 5550753, 5559720, 5,883,459, 6253227, 6282370, 6590188, 6976052, 6965815, 7030343, 7,417,834 b2, Canadian Patent: 2342614, Australian patent: 2373248 other patents both foreign and domestic applied for and pending.

Utilities

Key

- Indicates Flashing or Changing Segment
- Indicates Alternating or Progressive Message - every 1/2 second
- ⏏ A temperature button, used for "Action"
- ☰ Menu/Select button
- Waiting time that keeps the last change to a menu item.
- ***** Waiting time (depends on menu item) that reverts to original setting and ignores any change to that menu item.

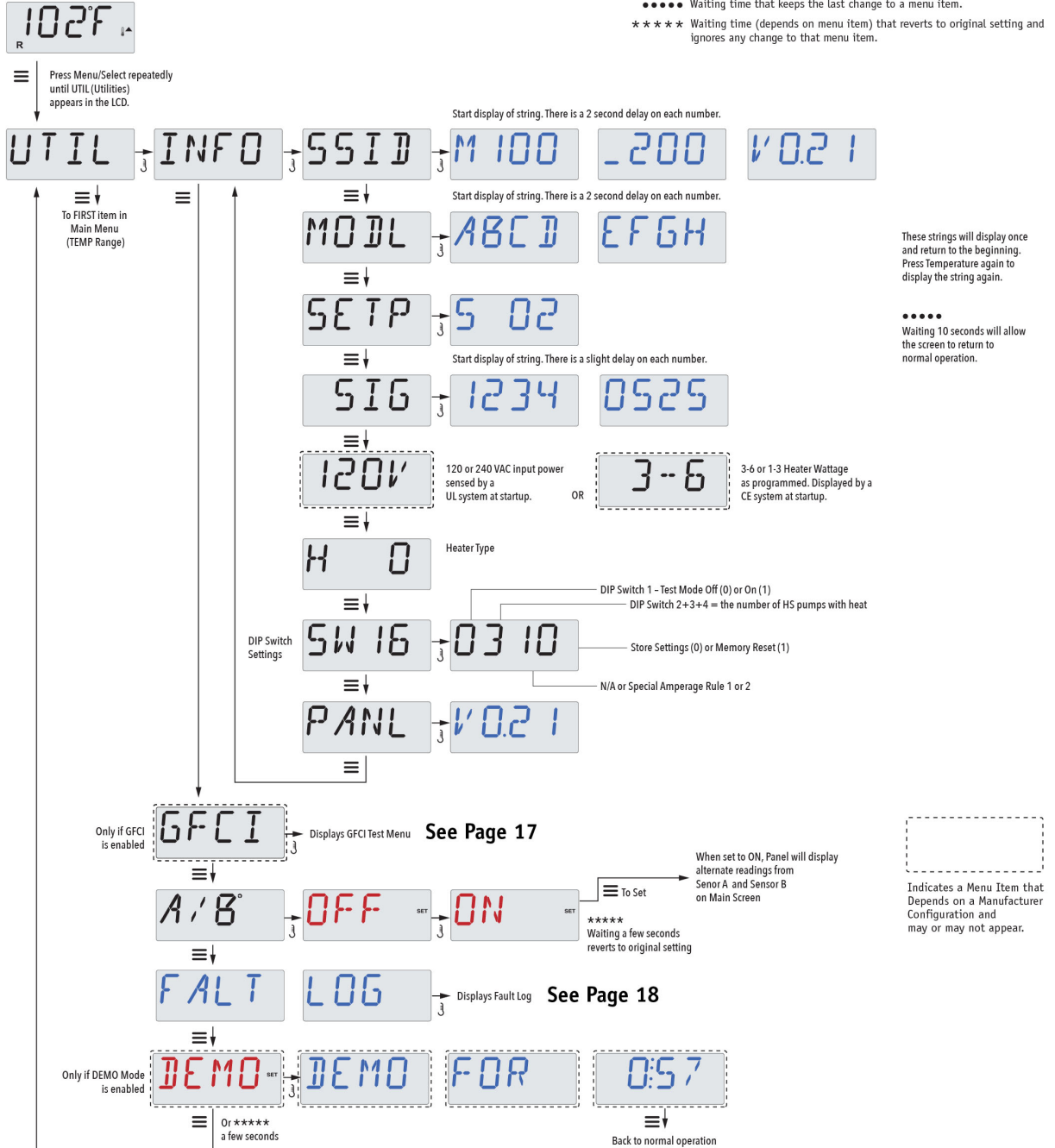

Manufactured under one or more of these patents. U.S. Patents: 5332944, 5361215, 5550753, 5559720, 5,883,459, 6253227, 6282370, 6590188, 6976052, 6965815, 7030343, 7,417,834 b2, Canadian Patent: 2342614, Australian patent: 2373248 other patents both foreign and domestic applied for and pending.

Utilities – GFCI Test Feature

Not Available on CE Rated Systems.

A GFCI is an important safety device and is required equipment on a hot tub installation.

Your spa may be equipped with a GFCI Protection feature. (UL rated systems only.) If your spa has this feature enabled by the manufacturer, the GFCI Trip Test must occur to allow proper spa function.

Within 1 to 7 days after startup, the spa will trip the GFCI to test it. (The number of days is factory programmed.) The GFCI must be reset once it has tripped. After passing the GFCI Trip Test, any subsequent GFCI trips will indicate a ground fault or other unsafe condition and the power to the spa must be shut off until a service person can correct the problem.

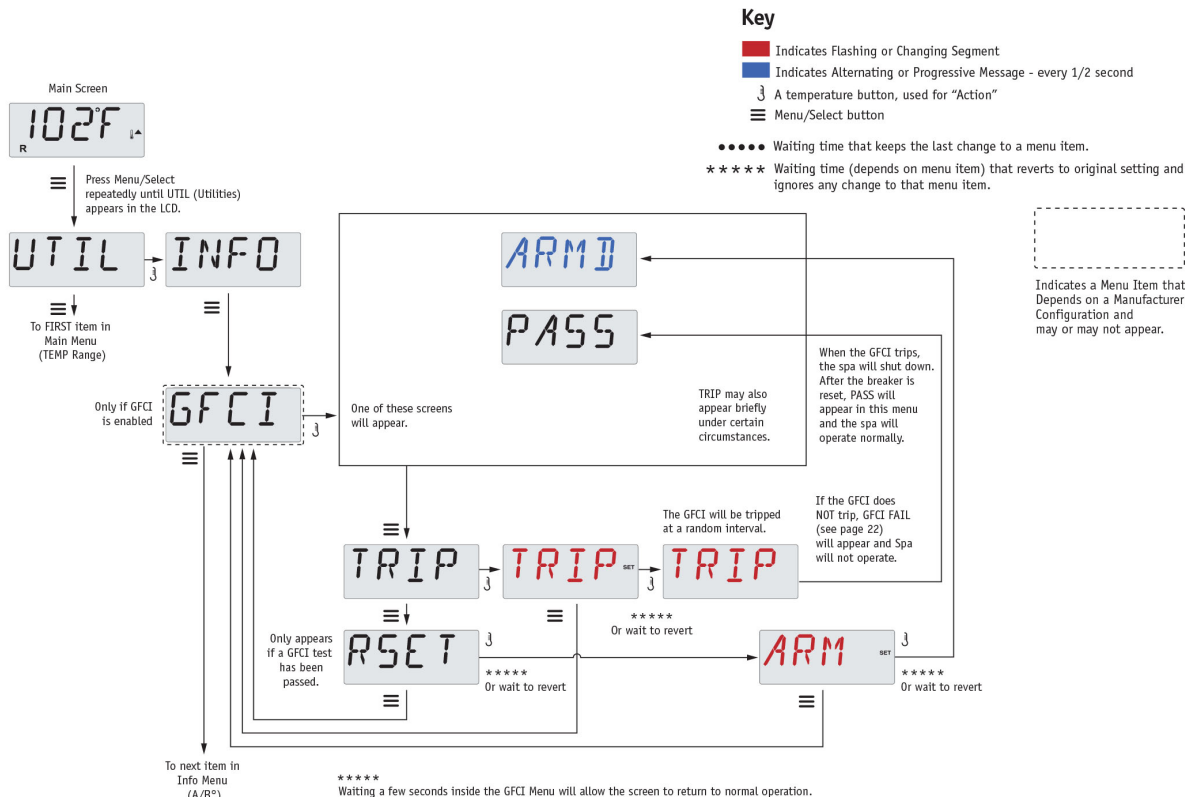

Forcing the GFCI Trip Test

The installer can cause the GFCI Trip Test to occur sooner by initiating it using the above menu.

The GFCI should trip within a few seconds and the spa should shut down. If it does not, shut down the power and manually verify that a GFCI breaker is installed and that the circuit and spa are wired correctly. Verify the function of the GFCI with its own test button. Restore power to the spa and repeat the GFCI Trip Test.

Once the GFCI is tripped by the test, reset the GFCI and the spa will operate normally from that point. You can verify a successful test by navigating to the above menu. PASS should appear after a temp button is pressed from the GFCI screen.

The end-user must be trained to expect this one-time test to occur and how to properly reset the GFCI.

Warning:

If freezing conditions exist, a GFCI should be reset immediately or spa damage could result. The end user should always be trained to test and reset the GFCI on a regular basis.

Manufactured under one or more of these patents. U.S. Patents: 5332944, 5361215, 5550753, 5559720, 5,883,459, 6253227, 6282370, 6590188, 6976052, 6965815, 7030343, 7,417,834 b2, Canadian Patent: 2342614, Australian patent: 2373248 other patents both foreign and domestic applied for and pending.

Utilities – Fault Log

A Little History can tell a lot

The Fault Log stores up to 24 events in memory and they can be reviewed under the Fault Log Menu.

Each event captures a Fault Message Code, how many days have passed since the fault, Time of the fault, Set Temperature during the fault, and Sensor A and B temperatures during the fault.

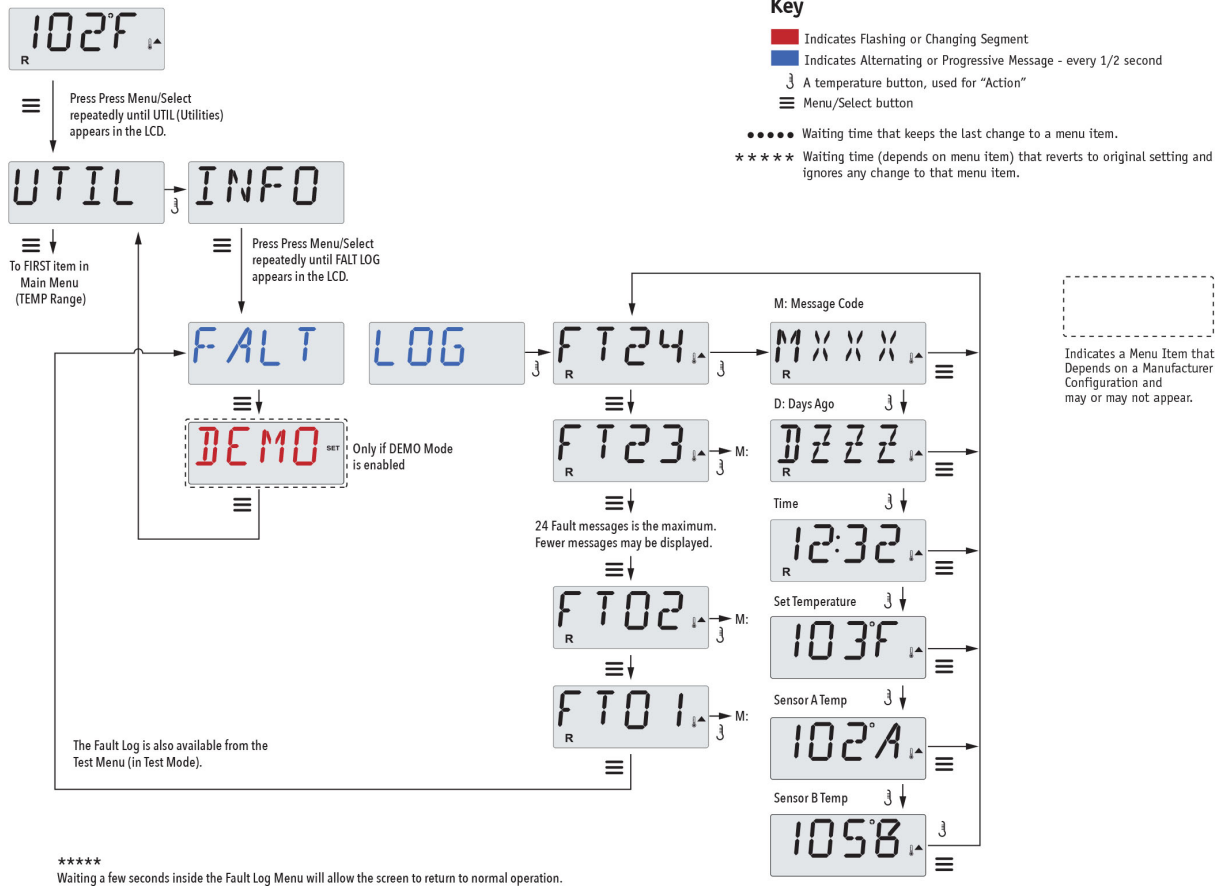

See following pages for various Message Codes and definitions.

Manufactured under one or more of these patents. U.S. Patents: 5332944, 5361215, 5550753, 5559720, 5,883,459, 6253227, 6282370, 6590188, 6976052, 6965815, 7030343, 7,417,834 b2, Canadian Patent: 2342614, Australian patent: 2373248 other patents both foreign and domestic applied for and pending.

Diagnostics



Priming Mode – M019

Each time the spa is powered up, it will enter Priming Mode. The purpose of Priming Mode is to allow the user to run each pump and manually verify that the pumps are primed (air is purged) and water is flowing. This typically requires observing the output of each pump separately, and is generally not possible in normal operation. Priming Mode lasts 4 minutes, but you can exit it earlier by pressing any Temp button. The heater is not allowed to run during Priming Mode.

NOTE: If your spa has a Circ Pump, it will turn on with "Light" in Priming Mode. The Circ Pump will run by itself when Priming Mode is exited.



Water Temperature is Unknown

After the pump has been running for 1 minute, the temperature will be displayed.



Too Cold - Freeze Protection

A potential freeze condition has been detected, or the Aux Freeze Switch has closed, and all pumps and blower are activated, either one at a time, or all at once, depending on how your system was built. All pumps and blower are ON for at least 4 minutes after the potential freeze condition has ended, or when the aux freeze switch opens.

In some cases, pumps may turn on and off and the heater may operate during Freeze Protection.

This is an operational message, not an error indication.



Water is too Hot (OHS) – M029

One of the water temp sensors has detected spa water temp 110°F (43.3°C) and spa functions are disabled. System will auto reset when the spa water temp is below 108°F (42.2°C). Check for extended pump operation or high ambient temp.



J29 Warning – M044

J29 is typically used as a Heater Disable input. As such, it should not typically be shorted at power-up. This message appears if J29 is shorted at power-up.

M0XX numbers are Message Codes. See Page 18.

* This message can be reset from the topside panel with any button press.

Manufactured under one or more of these patents. U.S. Patents: 5332944, 5361215, 5550753, 5559720, 5,883,459, 6253227, 6282370, 6590188, 6976052, 6965815, 7030343, 7,417,834 b2, Canadian Patent: 2342614, Australian patent: 2373248 other patents both foreign and domestic applied for and pending.

Heater-Related Messages



Heater Flow is Reduced (HFL) – M016

There may not be enough water flow through the heater to carry the heat away from the heating element. Heater start up will begin again after about 1 min. See “Flow Related Checks” below.



Heater Flow is Reduced (LF)* – M017

There is not enough water flow through the heater to carry the heat away from the heating element and the heater has been disabled. See “Flow Related Checks” below. After the problem has been resolved, you must press any button to reset and begin heater start up.



Heater may be Dry (dr)* – M028

Possible dry heater, or not enough water in the heater to start it. The spa is shut down for 15 min. Press any button to reset the heater start-up. See “Flow Related Checks” below.



Heater is Dry* – M027

There is not enough water in the heater to start it. The spa is shut down. After the problem has been resolved, you must press any button to reset and restart heater start up. See “Flow Related Checks” below.



Heater is too Hot (OHH)* – M030

One of the water temp sensors has detected 118°F (47.8°C) in the heater and the spa is shut down. You must press any button to reset when water is below 108°F (42.2°C). See “Flow Related Checks” below.



A Reset Message may Appear with other Messages.

Some errors may require power to be removed and restored.

Flow-Related Checks

Check for low water level, suction flow restrictions, closed valves, trapped air, too many closed jets and pump prime.

On some systems even when spa is shut down, some equipment may occasionally turn on to continue monitoring temperature or if freeze protection is needed.

* This message can be reset from the topside panel with any button press.

Manufactured under one or more of these patents. U.S. Patents: 5332944, 5361215, 5550753, 5559720, 5,883,459, 6253227, 6282370, 6590188, 6976052, 6965815, 7030343, 7,417,834 b2, Canadian Patent: 2342614, Australian patent: 2373248 other patents both foreign and domestic applied for and pending.

Sensor-Related Messages



Sensor Balance is Poor – M015

The temperature sensors MAY be out of sync by or 3°F. Call for Service.



Sensor Balance is Poor* – M026

The temperature sensors ARE out of sync. The Sensor Balance is Poor fault has been established for at least 1 hour. Call for Service.



Sensor Failure – Sensor A: M031, Sensor B: M032

A temperature sensor or sensor circuit has failed. Call for Service.

Miscellaneous Messages



No Communications

The control panel is not receiving communication from the System. Call for Service.



Pre-Production Software

The Control System is operating with test software. Call for Service.



°F or °C is replaced by °T

The Control System is in Test Mode. Call for Service.

* This message can be reset from the topside panel with any button press.

Manufactured under one or more of these patents. U.S. Patents: 5332944, 5361215, 5550753, 5559720, 5,883,459, 6253227, 6282370, 6590188, 6976052, 6965815, 7030343, 7,417,834 b2, Canadian Patent: 2342614, Australian patent: 2373248 other patents both foreign and domestic applied for and pending.

System-Related Messages

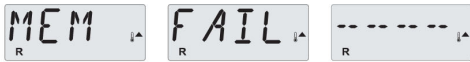

Memory Failure - Checksum Error* – M022

At Power-Up, the system has failed the Program Checksum Test. This indicates a problem with the firmware (operation program) and requires a service call.



Memory Warning - Persistent Memory Reset* – M021

Appears after any system setup change. Contact your dealer or service organization if this message appears on more than one power-up, or if it appears after the system has been running normally for a period of time.

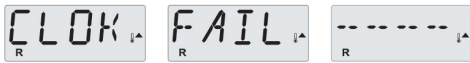

Memory Failure - Clock Error* – M020 - Not Applicable on the BP1500

Contact your dealer or service organization.

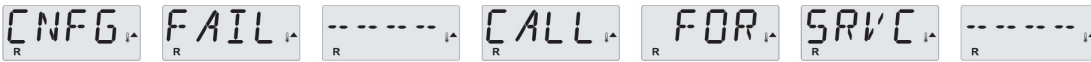

Configuration Error – Spa will not Start Up

Contact your dealer or service organization.

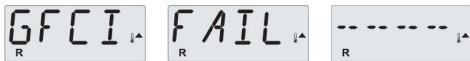

GFCI Failure - System Could Not Test/Trip the GFCI – M036

NORTH AMERICA ONLY. May indicate an unsafe installation. Contact your dealer or service organization.

* This message can be reset from the topside panel with any button press.

Manufactured under one or more of these patents. U.S. Patents: 5332944, 5361215, 5550753, 5559720, 5,883,459, 6253227, 6282370, 6590188, 6976052, 6965815, 7030343, 7,417,834 b2, Canadian Patent: 2342614, Australian patent: 2373248 other patents both foreign and domestic applied for and pending.

System-Related Messages



A Pump Appears to be Stuck ON – M034

Water may be overheated. POWER DOWN THE SPA. DO NOT ENTER THE WATER. Contact your dealer or service organization.

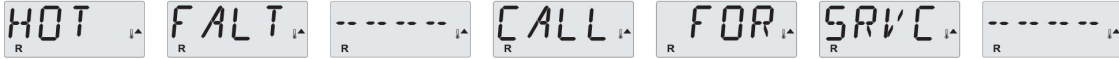

A Pump Appears to have been Stuck ON when spa was last powered - M035

POWER DOWN THE SPA. DO NOT ENTER THE WATER.

Contact your dealer or service organization.



The water level is too low

Some systems have a water level detect, and this message appears if it detects that the water level is too low.

* This message can be reset from the topside panel with any button press.

Manufactured under one or more of these patents. U.S. Patents: 5332944, 5361215, 5550753, 5559720, 5,883,450, 6253227, 6282370, 6590188, 6976052, 6965815, 7030343, 7,417,834 b2, Canadian Patent: 2342614, Australian patent: 2373248 other patents both foreign and domestic applied for and pending.

Reminder Messages

General maintenance helps.

The display of Reminder Messages can be suppressed by using the PREF Menu. See Page 12.

Reminder Messages can be chosen individually by the Manufacturer. They may be disabled entirely, or there may be a limited number of reminders on a specific model.

The frequency of each reminder (e.g. 7 days) can be specified by the Manufacturer.

Press a Temperature button to reset a displayed reminder message.



Alternates with temperature or normal display.

Appears on a regular schedule, e.g. every 7 days.

Check pH with a test kit and adjust pH with the appropriate chemicals.



Alternates with temperature or normal display.

Appears on a regular schedule, e.g. every 7 days.

Check sanitizer level and other water chemistry with a test kit and adjust with the appropriate chemicals.



Alternates with temperature or normal display.

Appears on a regular schedule, e.g. every 30 days.

Clean the filter media as instructed by the manufacturer. See HOLD on page 9.



Alternates with temperature or normal display.

Appears on a regular schedule, e.g. every 30 days.

The Ground Fault Circuit Interrupter (GFCI) or Residual Current Device (RCD) is an important safety device and must be tested on a regular basis to verify its reliability.

Every user should be trained to safely test the GFCI or RCD associated with the hot tub installation.

A GFCI or RCD will have a TEST and RESET button on it that allows a user to verify proper function.

Warning:

If freezing conditions exist, a GFCI or RCD should be reset immediately or spa damage could result. The end user should always be trained to test and reset the GFCI or RCD on a regular basis.

Manufactured under one or more of these patents. U.S. Patents: 5332944, 5361215, 5550753, 5559720, 5,883,459, 6253227, 6282370, 6590188, 6976052, 6965815, 7030343, 7,417,834 b2, Canadian Patent: 2342614, Australian patent: 2373248 other patents both foreign and domestic applied for and pending.

Reminder Messages Continued



Alternates with temperature or normal display.

Appears on a regular schedule, e.g. every 90 days.

Change the water in the spa on regular basis to maintain proper chemical balance and sanitary conditions.



Alternates with temperature or normal display.

Appears on a regular schedule, e.g. every 180 days.

Vinyl covers should be cleaned and conditioned for maximum life.



Alternates with temperature or normal display.

Appears on a regular schedule, e.g. every 180 days.

Wood skirting and furniture should be cleaned and conditioned per the manufacturers instructions for maximum life.



Alternates with temperature or normal display.

Appears on a regular schedule, e.g. every 365 days.

Filters should be replaced occasionally to maintain proper spa function and sanitary conditions.



Alternates with temperature or normal display.

As needed.

Install new mineral cartridge.



Alternates with temperature or normal display.

Appears on a regular schedule, e.g. every 365 days.

Check your ozone and/or UV generator per your spa manufacturer's instructions.



Alternates with temperature or normal display.

Appears on a regular schedule, e.g. every 365 days.

Have a service technician do a check-up on your spa per your spa manufacturer's instructions.

Manufactured under one or more of these patents. U.S. Patents: 5332944, 5361215, 5550753, 5559720, 5,883,459, 6253227, 6282370, 6590188, 6976052, 6965815, 7030343, 7,417,834 b2, Canadian Patent: 2342614, Australian patent: 2373248 other patents both foreign and domestic applied for and pending.

Warning! Qualified Technician Required for Service and Installation

Basic Installation and Configuration Guidelines

Use minimum 6AWG copper conductors only.

Torque field connections between 21 and 23 in lbs.

Readily accessible disconnecting means to be provided at time of installation.

Permanently connected.

Connect only to a circuit protected by a Class A Ground Fault Circuit Interrupter (GFCI) or Residual Current Device (RCD) mounted at least 5' (1.52M) from the inside walls of the spa/hot tub and in line of sight from the equipment compartment.

CSA enclosure: Type 2

Refer to Wiring Diagram inside the cover of the control enclosure.

Refer to Installation and Safety Instructions provided by the spa manufacturer.

Warning: People with infectious diseases should not use a spa or hot tub.

Warning: To avoid injury, exercise care when entering or exiting the spa or hot tub.

Warning: Do not use a spa or hot tub immediately following strenuous exercise

Warning: Prolonged immersion in a spa or hot tub may be injurious to your health

Warning: Maintain water chemistry in accordance with the Manufacturers instructions.

Warning: The equipment and controls shall be located not less than 1.5 meters horizontally from the spa or hot tub.

Warning! GFCI or RCD Protection.

The Owner should test and reset the GFCI or RCD on a regular basis to verify its function.

Warning! Shock Hazard! No User Serviceable Parts.

Do not attempt service of this control system. Contact your dealer or service organization for assistance. Follow all owner's manual power connection instructions. Installation must be performed by a licensed electrician and all grounding connections must be properly installed.

CSA Compliance/Conformité

Caution:

- Test the ground fault circuit interrupter or residual current device before each use of the spa.
- Read the instruction manual.
- Adequate drainage must be provided if the equipment is to be installed in a pit.
- For use only within an enclosure rated CSA Enclosure 3.
- Connect only to a circuit protected by a Class A ground fault circuit interrupter or residual current device.
- To ensure continued protection against shock hazard, use only identical replacement parts when servicing.

- Install a suitably rated suction guard to match the maximum flow rate marked.

Warning:

- Water temperature in excess of 38°C may be injurious to your health.
- Disconnect the electrical power before servicing.

Attention:

- Toujours vérifier l'efficacité du disjoncteur différentiel avant d'utiliser différentiel avant d'utiliser le bain.
- Lire la notice technique.
- Lorsque l'appareillage est installé dans une fosse, on doit assurer un drainage adéquat.
- Employer uniquement à l'intérieur d'une clôture CSA Enclosure 3.
- Connecter uniquement à un circuit protégé par un disjoncteur différentiel de Class A.
- Afin d'assurer une protection permanente contre le danger de choc électrique, lors de l'entretien employer seulement des pièces de rechange identiques.
- Les prises d'aspiration doivent être équipées de grilles convenant au débit maximal indiqué.

Avertissement:

- Des températures de l'eau supérieures à 38°C peuvent présenter un danger pour la santé.
- Déconnecter du circuit d'alimentation électrique avant l'entretien.

Warning/Advertissement:

- Disconnect the electric power before servicing. Keep access door closed.
- Déconnecter du circuit d'alimentation électrique avant l'entretien. Garder la porte fermée.

Manufactured under one or more of these patents. U.S. Patents: 5332944, 5361215, 5550753, 5559720, 5,883,459, 6253227, 6282370, 6590188, 6976052, 6965815, 7030343, 7,417,834 b2, Canadian Patent: 2342614, Australian patent: 2373248 other patents both foreign and domestic applied for and pending.

Jets

Almost all of the jets in your spa are adjustable. Rotating the face of an adjustable jet to the left (counterclockwise) will decrease the amount of water flow through the jet. Rotating the face of an adjustable jet to the right (clockwise) will increase the amount of water flow through the jet. (See example shown here.)

Neck jets adjust in the opposite directions (counterclockwise to increase, clockwise to decrease).

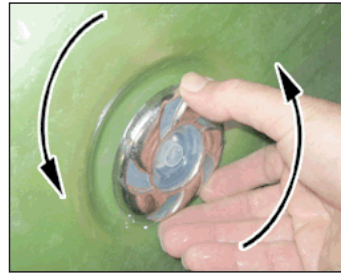

Diverter Knobs

Diverter knobs are 1" and 2" knobs located around the top of your spa. They allow you to divert water through jets from one side of the spa to the other, or in most cases from floor jets to wall jets. This is accomplished by rotating the diverter knob to the left (counterclockwise), decreasing the amount of water flow through a section of jets. To increase the amount of water flow through the other section of jets, rotate the handle to the right (clockwise).



Air Venturis

Air venturis are the 1" knobs located around the top of your spa. Each one will let you add a mixture of air with the jet pressure. This is accomplished by rotating the air venturi knob to the left (counterclockwise) to increase the amount of airflow through the jets. To decrease the amount of airflow through the jets, rotate the handle to the right (clockwise).



Water Clarity

This section is intended for new spa owners with no experience with water chemistry. Everyone's experience with maintaining water quality is different, but there are some general concepts you need to know.

Water maintenance is not difficult, although it requires regular attention. The most important thing to understand about taking care of your spa water is that preventive action is much easier than correcting water quality issues.

Before you begin, we recommend you become familiar with some water quality terms and their definitions (see next page).

Whether you're filling your spa for the first time (see page 7) or refilling it after draining it for regular maintenance (see page 50), start and maintain your spa water by following the plan we describe in this section.

1 Chemical Balance

See page 40 to learn how to balance your spa water.



You will need to test and adjust the chemical balance of your spa water. Although this is not difficult, it needs to be done regularly.

You need to test the level of calcium hardness, total alkalinity, and pH.

Spa owners with a bromine generator also need to check

3 frequency and intensity of use.

Spa owners with an ozonator also need to add sanitizer, although their requirements are different.



Filtration

See page 43 for filter cleaning instructions.

Cleaning your filter regularly is the easiest and most effective single thing you can do to keep your water clear.

A clogged or dirty filter will cause the heater

2 total dissolved solids and phosphates.

Sanitation and Shock



See page 42 to learn how to use sanitizer and shock.

Sanitizers kill bacteria and viruses and keep the water clean. A low sanitizer level will allow microbes to grow quickly in the spa water. We recommend using either chlorine or

bromine as your sanitizer.

You also need to add shock to the water to stimulate the chemical sanitizer. How much you use and how often depend

4 and pump to work harder than they need to, possibly causing them to fail.

The spa's heating system will only function with the proper amount of water flow through the system.



Regularity

See page 44 for the schedule of recommended maintenance.

Clear water requires regular maintenance. Establish a routine based on a regular schedule for your spa water maintenance.

Maintaining your water quality helps the enjoyment of your spa and extends your spa's life by preventing damage from neglect and chemical abuse.

Water Quality Terms and Definitions

The following chemical terms are used in this section. Understanding their meaning will help you to better understand clear water maintenance. Words in bold type are defined in this table.

Bromine / Bromamines

Bromine is an efficient sanitizer chemical for spas. When used as a **sanitizer**, bromine forms compounds called bromamines. Bromine can be added to the spa or automatically generated. See page 42 for discussion on **sanitizers**.

Bromamines are compounds formed when bromine combines with nitrogen from body oils, perspiration, etc. Unlike chloramines, bromamines have no pungent odor and are effective **sanitizers**.

Chlorine / Chloramines

Chlorine is an efficient sanitizing chemical for spas. We recommend using sodium dichlor-type granulated chlorine because it is totally soluble and nearly **pH** neutral. When used as a **sanitizer**, chlorine forms compounds called chloramines. See page 42 for discussion on **sanitizers**.

Chloramines are compounds formed when chlorine combines with nitrogen from body oils, perspiration, etc. Chloramines can cause eye irritation as well as having a strong odor. Unlike **bromamines**, chloramines are weaker, slower **sanitizers**. To remove chloramines, see the description of **shock** below.

Calcium Hardness	Abbreviated as CH. Calcium hardness is a measure of the total amount of dissolved calcium in the water. Calcium helps control the corrosive nature of the spa's water and is why soft water is not recommended. The low CH level can cause corrosion to the equipment and can cause staining of the spa shell. See page 41 for testing for and balancing calcium hardness.
Corrosion	The gradual wearing away of metal spa parts, usually caused by chemical action. Generally, corrosion is caused by low pH or by water with levels of TA, CH, pH or sanitizer which are outside the recommended ranges.
Dichlor	Also called sodium dichlor. It is a type of chlorine and is frequently used when shocking the water . An effective chlorine -based powdered oxidizer and sanitizer . Dichlor works by oxidizing waste product in the water such as bromamines and chloramines and causing them to burn off.
Monopersulphate or MPS	Frequently used when shocking the water . An effective non-chlorine-based powdered oxidizer that works well with both chlorine and bromine . It works by oxidizing waste product in the water such as bromamines and chloramines and causing them to burn off.
Oxidizer	Shocking the water with an oxidizing chemical prevents the buildup of contaminants, maximizes sanitizer efficiency, minimizes combined chlorine and improves water clarity.
Ozone	Ozone is a powerful oxidizing agent which is produced in nature and artificially. Ozone forms no by-products of chloramines (ozone actually oxidizes chloramines) and will not alter the water's pH .
pH	The pH level is the measure of the balance between acidity and alkalinity. Low pH causes the water to be too acid, which will cause corrosion , whereas high pH causes the water to be too alkaline, which will cause scaling . See page 41 for testing for and balancing pH.
ppm	The abbreviation of "parts per million", the standard measurement of chemical concentration in water. Identical to mg/l (milligrams per liter).
Sanitizer	Sanitizer is a chemical added to the water to kill bacteria and viruses and keep the water clean. The two sanitizers we recommend are chlorine and bromine . See page 42 for discussion of sanitation.
Scale	Rough calcium-bearing deposits that can coat spa surfaces, heaters, plumbing lines and clog filters. Generally, scaling is caused by mineral content combined with high pH . Additionally, scale forms more readily at higher water temperatures.
Shock	Also called shocking the water, shock treatment, or superchlorination. Shocking the water is adding significant doses of dichlor or MPS to oxidize non-filterable organic waste and to remove chloramines and bromamines . Shock treatment breaks down organic waste contaminants which cause odor and cloudy water. See page 43 for discussion of shocking the water.
Total Alkalinity	Abbreviated as TA. Total alkalinity is the measure of the total levels of carbonates, bicarbonates, hydroxides, and other alkaline substances in the water. TA is important for pH control. If the TA is too low, the pH will fluctuate out of control, and if it is too high, the pH becomes difficult to stabilize. See page 40 for testing for and balancing total alkalinity.
Trichlor	Used as a pool sanitizer . NEVER use trichlor in a spa. Trichlor is extremely acidic and will lower the pH , causing corrosion to equipment. Using trichlor will void your warranty.

Water Testing Methods

There are two testing methods to choose from:

Test strips are a convenient testing method commonly used by spa owners.



The reagent test kit is a method which provides a high level of accuracy but is more expensive and more difficult to use.



Adding Chemicals to the Spa Water

IMPORTANT: All spa water chemicals, including MPS (shock), chlorine, granulated pH increaser or decreaser, granulated total alkalinity increaser, calcium hardness increaser, liquid stain and scale inhibitor, and liquid de-foamer must always be added directly into or in front of the filter compartment while a jet pump is running, and it must run for a minimum of ten minutes.

1. Fold back the cover.
2. Press the **Jets** button.
3. Carefully measure the recommended amount of chemical and slowly pour it into the filter area. Use care not to splash chemicals on your hands, in your eyes, on the spa surface, or on the siding.
4. Close the spa cover.

Warning: High sanitizer levels can cause discomfort to the user's eyes, lungs and skin. Always allow the sanitizer level to fall to the recommended range before using the spa.

IMPORTANT NOTE REGARDING SHOCK TREATMENT: After administering shock to your spa, leave the cover open for a minimum of 20 minutes to allow the oxidizer gas to vent. A high concentration of trapped oxidizer gas which may exist as a result of the shock treatment (not daily sanitation) may eventually cause discoloration or vinyl degradation to the bottom of the cover. This type of damage is considered chemical abuse and is not covered under the terms of the limited warranty.

1. Balancing the Water Chemistry Levels

Maintaining spa water chemistry can be tricky, especially since there are many methods of keeping your water clear and clean. Follow the maintenance schedule on page 44 to determine how often you should test your water.

We do not recommend any brand of chemical. See page 44 for a table of common chemicals used in spas and their generic equivalents.

See a spa dealer for guidance and recommendations on spa chemicals and supplies. Various chemicals often sold under brand names, but a spa dealer can advise you on generic chemicals that are often much less costly than proprietary brands.

Balancing the Total Alkalinity (TA)

Total Alkalinity is a measure of the total levels of carbonates, bicarbonates, hydroxides, and other alkaline substances in the water. TA is referred to as the water's "pH buffer". In other words, it's a measure of the ability of the water to resist changes in pH level.

If the TA is too low, the pH level will fluctuate widely from high to low. Fluctuations in pH can cause corrosion or scaling of the spa components. Low TA can be corrected by adding sodium carbonate (pH/Alkalinity Up).

If the Total Alkalinity is too high, the pH level will tend to be high and may be difficult to bring down. It can be lowered by using sodium bisulfate (pH/Alkalinity Down).

Once the TA is balanced, it normally remains stable, although the addition of more water with a high or low alkalinity will raise or lower the TA reading of the water.

When the Total Alkalinity is within the recommended range, proceed to the next step.

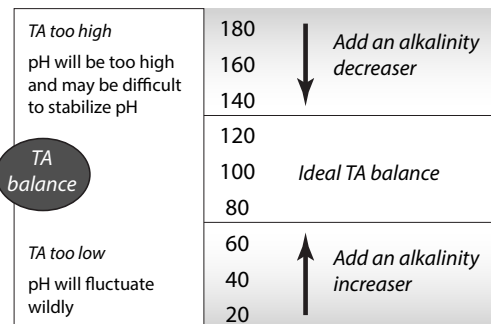

Balancing the Calcium Hardness (CH)

Calcium Hardness is a measure of the total amount of dissolved calcium in the water. Calcium helps control the corrosive nature of the spa's water. That's why calcium-low water (commonly known as "soft" water) is not recommended. It is very corrosive to the equipment, and can cause staining of the spa shell.

If the CH is too high (commonly known as "hard water"), formation of scale on the spa's shell surface and equipment can result. You can use a generic calcium remover to remove hardness from water. CH can also be decreased by dilution – a mixture of 75% hard and 25% soft water will usually yield a reading within the correct range. If soft water is not available or practical for you, a stain and scale inhibitor should be added to the spa water, according to label instructions.

If the CH is too low add CH Increaser.

Once the CH is balanced, it normally remains stable, although the addition of more water with a high or low calcium content will raise or lower the CH reading of the water.

When the CH is within the recommended range, proceed to the next step.

CH too high Causes scale to deposit on spa and equipment	275	↓ Dilute the spa with soft water
	250	
CH balance	225	Ideal CH balance
	200	
	175	
	150	
CH too low Causes equipment corrosion	125	↑ Add a calcium hardness increaser
	100	
	75	

Balancing the pH

The pH level is the measure of acidity and alkalinity. Values above 7.8 are alkaline; those below 7.2 are acidic. Maintaining the proper pH level is extremely important for optimizing the effectiveness of the sanitizer, maintaining water that is comfortable for the user, and preventing equipment deterioration.

If the spa water's pH level is too low, the following may result:

- The sanitizer will dissipate rapidly.
- The water may become irritating to spa users.
- The spa's equipment may corrode.

If the pH is too low, it can be increased by adding sodium hydrogen carbonate (pH/Alkalinity Up) to the spa water.

If the pH level is too high, the following may result:

- The sanitizer is less effective.
- Scale will form on the spa shell surface and the equipment.
- The water may become cloudy.
- The filter cartridge pores may become obstructed.

If the pH is too high, it can be decreased by adding sodium bisulfate (pH/Alkalinity Down) to the spa water.

NOTE: After adding sodium hydrogen carbonate or sodium bisulfate, wait two hours before testing the water for pH. Measurements taken too soon may not be accurate.

It is important to check the pH on a regular (weekly) basis. The pH will be affected by the bather load, the addition of new water, the addition of various chemicals, and the type of sanitizer used.

When the pH is within the recommended range, proceed to sanitation.

pH too high Too alkaline, causes scaling	8.2	↓ Add a pH decreaser
	8.0	
pH balance	7.8	Ideal pH balance
	7.6	
	7.4	
	7.2	
pH too low Too acidic, causes corrosion	7.0	↑ Add a pH increaser
	6.8	
	6.6	

2. Sanitation and Shock

Sanitizers kill bacteria and other organic waste by breaking them down to non-harmful levels which are filtered out. Before you fill your spa, you need to decide which chemical sanitizer you wish to use. Consult your Cal Spas dealer for the right decision with regards to your lifestyle and spa usage.

We recommend either **bromine** or **chlorine** as your sanitizer. Both work well when maintained regularly.



DO NOT use Trichlor. Trichlor is very acidic and the hot temperature of the spa causes it to dissolve too quickly. It will cause damage to your spa and will void your warranty.

Whichever plan you decide on, follow it completely and don't take shortcuts. It will provide you with clean, safe, clear spa water with a minimum of effort. Spa owners with an ozonator still need to use a chemical sanitizer. See page

47 for a description of how the ozonator works.

Whenever you test your chemical levels, your test strip will likely have a test for chlorine or bromine. Make sure your sanitizer falls within the range shown below.

Testing For:	Ideal Range (ppm)	
	Minimum	Maximum
Chlorine Level		
Without ozonator	3.0	5.0
With ozonator	2.0	4.0
Bromine Level		
Without ozonator	6.7	11.0
With ozonator	5.7	10.0

Starting and Maintaining Sanitizer Levels

Sanitizing your spa with chlorine or bromine is very similar. Each sanitizer has its advantages and disadvantages.

Bromine: Whereas chlorine can sometimes cause offensive odors and skin irritation, bromine is less likely to do so. Additionally, unlike chlorine, when bromine combines with bather waste and other contaminants in the water, it remains a very effective sanitizer. Bromine is also far less pH-dependent than chlorine. **Always remember that bromine by itself is not a sanitizer, and it needs to be activated by shock in order to be effective.**

Chlorine: The most commonly recognized sanitizer is chlorine. However, the effectiveness of chlorine depends heavily on the pH level of the spa water. In order to get the most effective and economical benefit of chlorine, you must maintain a consistent pH level of between 7.2 to 7.6. A disadvantage of using chlorine is that when chlorine combines with bather waste and other contaminants in the water, not only does it lose its sanitizing ability, it can cause odors and irritate eyes and skin.

After you choose a sanitizer, you will need to establish a baseline and maintain it regularly.

Starting with fresh water:

1. Establish a baseline by adding either granulated chlorine or bromine.
 - Use half an ounce of chlorine for every 500 gallons of water.
 - Use half an ounce of bromine for every 100 gallons of water.
2. Run the jets for 10 minutes.
3. Test the water. Make sure the pH, TA, and CH levels all fall within the ranges shown on the previous page. Make adjustments where they are needed.
4. At this point, if you use bromine, it is not yet activated and **it will not sanitize the water**. You need to shock-oxidize the spa water. Depending on the size of your spa, add one to two ounces of shock. You can use any kind of shock you want.
5. Test the water again. When the water is balanced, your spa is ready to use.

Note: If you choose to use bromine, we do not recommend using a floater. You have more control over the bromine level by adding bromine as needed. For more discussion on this, see page 45, "Common Water Chemistry Questions".

Shocking the Water

In addition to using a chemical sanitizer, you will periodically need to shock the water. Shocking helps refresh the water by breaking down organic waste contaminants which cause odor and cloudy water. After treatment, water quality and clarity is often completely restored.

The two types of shock are sodium dichlor and potassium monopersulfate (MPS). You can use either type of shock regardless of which sanitizer you use. Even if you use bromine, you can use a chlorinated shock if you wish -- in fact, you may find a chlorinated shock is more effective than dichlor or MPS alone.

If irritating chloramines are present, shocking also converts them back to active chlorine. If you use bromine sanitizer, shocking activates the bromide ion (which by itself has no disinfecting capability) which becomes hypobromous acid in water, a good sanitizer.

Add one ounce of oxidizer shock once a week, after heavy bather loads, or if water has a strong odor.

Spa must be running with all of the jets on high for 30 minutes with the cover open. If necessary, repeat shock in 30 minute intervals.

3. Filtration

The filter is the part of your spa that removes the debris from the water and needs to be cleaned on a regular basis to maximize your spa's filtering performance and heating efficiency.

It is extremely important that you never run the spa without a filter. There is a possibility that debris may be sucked into the plumbing through the filter well.

Cleaning the Filter

In addition to spraying off the filter weekly to remove surface debris, your filter should be deep cleaned periodically to dissolve scale and particles that get lodged deep within the filter fibers and impede the filtration process. Even if the filter looks clean, scale and particles can clog the fibers and prevent water from flowing through the filter resulting in the most common spa problem—no heat, caused by a dirty filter.

We recommend you clean your filter at least once a month, possibly every two weeks depending on how frequently you use your spa, and replace it once a year or as necessary. See page 51 for instructions on removing and cleaning the filter.

4. Regularity (Maintenance Schedule)

Prior to each use	Test the spa water. Adjust chemical levels as necessary. Shock the water by adding ½ teaspoon of sodium dichlor per 250 gallons or 1 teaspoon of MPS per 250 gallons.
After each use	Add an ounce of oxidizer after heavy bather loads (see page 43 on shocking the water).
Once a week	Check the filter well and inside the filter pipe for leaves and foreign matter. Test the spa water. Adjust chemical levels as necessary. Shock the water by adding ½ teaspoon of sodium per 250 gallons or 3 teaspoons of MPS per 250 gallons. If your water source is high in calcium, add stain and scale preventer.
Every two to four weeks	Deep clean your spa's filter (see page 51). How often you clean your filter depends on how much you use your spa. There is no harm in frequently cleaning your filter and will only help your spa's efficiency.
Every two to four months	Change the spa water. How often you change the water depends on how much you use the spa. When you change the water, you will need to: <ul style="list-style-type: none"> • Clean and polish the acrylic surface (see page 53) • Clean and treat the spa cover and pillows (see page 53) • Deep clean the filter (see page 51) • Refill your spa (see page 7)
Each time you refill the spa	Follow the section "Filling and Powering Up Your Portable Spa" on page 7.
Once a year	Replace filter cartridges if the pleats appear frayed (see page 51).

Generic Names for Chemicals

Water Chemistry		
Common name	Usual chemical name	Common brand names
pH Up	sodium hydroxide	pH Increaser, pH Up, pH Plus, pH Booster
pH Down	sodium bisulfate sodium bicarbonate (baking soda) sodium carbonate	pH Decreaser, pH Down, pH Minus, pH Subtractor, Dry Acid
Alkalinity increaser	sodium carbonate sodium bicarbonate (baking soda)	Alkalinity Increaser, Alkaline Up
Alkalinity decreaser	sodium bisulfate	Alkalinity Decreaser, Alkaline Down
Calcium increaser	calcium chloride	Calcium Increaser, Calcium Up, Calcium Plus, Hardness Increaser
Calcium decreaser	N/A To decrease calcium hardness, drain several gallons of water from the spa and refill using a mixture of 75% hard water and 25% soft water, or use a stain and scale inhibitor.	

Sanitizers		
Common name	Usual chemical name	Common brand names
Chlorine	sodium dichlor	Both chlorine and bromine are available under numerous brand names
Bromine	sodium bromide	

Shock		
Common name	Usual chemical name	Common brand names
MPS	monopersulphate	MPS Shock, Oxy-Spa, SeaKlear
Dichlor	sodium dichlor	Dichlor Shock

Note: Dichlor (chlorine) is both a sanitizer and a shock. Monopersulphate (MPS), when used as a shock, can be purchased alone as non-chlorinated shock or combined with dichlor, which makes it significantly more effective than MPS alone.

Other chemical additives		
Common name	Usual chemical name	Common brand names
Stain and scale inhibitor	These are usually proprietary chemical formulations and cannot be purchased as a single generic chemical.	Metal Stain Gone, Scale Inhibitor, Stain and Scale Preventer, Stain and Scale Defense
Foam inhibitor		Foam Gone, Foam Down, Defoamer
Clarifier		Water Brite, Spa Bright, Water Clarifier, Clear Water, Natural Clarifier, Brite & Clear

Do NOT use these in your spa:

- Sodium hypochlorite (household bleach)
- Trichlor
- Chemical floaters
- Bromine tablets
- Muriatic acid
- Borax or boric acid in any form, including brand names such as 20 Mule Team Borax or generic as sodium tetraborate
- Cyanuric acid, also called sun protector or chlorine protector

Common Water Chemistry Questions

Question: Why is the use a floater not recommended to sanitize my spa water?

Answer: We do not recommend the use of a floater for three reasons:

- The floater is unable to control the rate at which the sanitizer is dissolved into the water. When a floater is first placed in a spa, the sanitizer level can be extremely high. High sanitizer levels can chemically burn or discolor the spa's shell or the underside of the cover. Then, after a period of time, the sanitizer level dispensed by the floater will fall to near zero. A low sanitizer level will allow viruses, bacteria or algae to grow.
- Floaters tend to stay in one area of the spa most of the time, causing this area to be exposed to extreme sanitizer levels.
- The floater may allow pieces of the highly concentrated sanitizer to fall out and settle on the floor or seat of the spa shell. These pieces of sanitizer will chemically burn (blister) the spa shell. Although your spa shell is specifically designed to resist the effects of spa chemicals, no spa surface can withstand this type of highly concentrated chemical. Remember, chemical abuse is specifically not covered under the terms of the warranty.

Question: When I open my spa, I smell chlorine. How do I get rid of this smell?

Answer: There are two types of chlorine in your spa. The first is the Free Available Chlorine, which is the chlorine available to sanitize your spa. This free Available Chlorine does not have an odor. The second is Chloramine, which is residue from chlorine already expended. Chloramines have a strong chlorine odor. The smell from Chloramines can be eliminated by shocking the water. If you smell chlorine in the water, your spa is reminding

you to add a shock treatment.

Question: Why can't I fill my spa with soft water?

Answer: Soft water is essentially the same as regular water, except that most or all of the calcium has been replaced by sodium. Soft water may be corrosive to the heater and other components. Replacement of spa components damaged by soft water is extremely expensive.

Question: I am trying to reduce the number of chemicals to which my family is exposed. Do I really need to use so many chemicals and in such large amounts?

Answer: While over-exposure to any chemical can be unhealthy, many low levels of chemicals are effective and beneficial. In the case of spa water, the chemicals we recommend are needed to protect the user from water-borne pathogens (disease-causing microbes) and to prevent corrosion of spa components.

Question: Why isn't water chemistry damage covered by the warranty?

Answer: The chemical levels and water quality of the water in the spa are under your direct control. With proper basic care, the spa will provide many years of hot water relaxation. If you are unsure about any chemical or its usage in the spa, contact your spa dealer.

Do's and Don'ts

- DO add all chemicals slowly into or in front of the filter compartment with the jet pump operating for ten minutes.
- DO use special care if using baking soda to clean either the interior or exterior plastic surfaces.
- DO use only a granular form of bromine sanitizer.
- DON'T use swimming pool (muriatic) acid to lower pH.
- DON'T splash pH increaser additives on the siding.
- DON'T use compressed sanitizers.

The use of bromine sticks or tablets in floaters, which may become trapped in a lounge or cooling seat (or sink to the spa floor), have been shown to cause discoloration of or surface distress to a spa's shell.

- DON'T use a floater type sanitization system as a low or no maintenance solution to your spa maintenance program.

Floating dispensers can become trapped in one area and cause an over-sanitization (or chemical burn) of that particular area.

If the dispenser setting is too high, the high concentration can discolor the spa shell and damage the underside of the cover.

Automatic floating dispensers have a tendency to either over-brominate or under-brominate as the rate of erosion varies greatly. Damage to the spa and cover can occur very quickly.

- DON'T use a sanitizer which is not designed for spas.
- DON'T use household bleach (liquid sodium hypochlorite).
- DON'T broadcast or sprinkle the chemicals onto the water surface. This method may cause chemically-induced spa surface blistering (chemical abuse).

Bather Load

"Bather Load" is the term used to describe the number of people using a spa, combined with the length of usage, and the frequency of usage. All these factors have a great effect on the spa water. The higher the bather load, the more chemicals need to be added and a longer filtration time will be needed.

Recommendations are designed for spas with average bather load (3 to 4 people, 15 minutes of usage, three times a week at 100 degrees) If your bather load exceeds these guidelines, and you experience water quality problems, increase the amount of filtration first, (go to the next higher filtration number) then if water quality is still not adequate, consult the advice of your Cal Spas dealer for additional chemical or system recommendations. Be sure to give them your bather load information.

Ozonator

The ozone generator releases ozone into the spa water. You will still need to test for chlorine or bromine and occasionally replenish it to return the sanitizer level to the baseline.

For spas without a circulation pump, pump 1 will run at low speed and the ozonator will run during filtration. You will need to increase your filtration to a minimum of six hours per day.

For spas with a circulation pump, the ozonator will run with the circulation pump.

The spa's control system is factory-programmed with one filter cycle that will run in the evening when energy rates are often lower. The time and duration of the filter cycle can be set according to your needs. In addition, a second filter cycle can be enabled. Filtration time may need to be increased with heavy bather load.

See instructions for setting filtration cycles on page 20.

Always make sure water diverter valves are turned all the way to the left or right and never left in the center position during filtration cycles. When the diverter valve is in the center position, there is not enough suction from the pump in order to inject ozone into the spa. The ozonator will generate ozone, but it will not be injected into the water.

Troubleshooting Water Clarity Problems

Problem	Probable Causes	Possible Solutions
Cloudy Water	Dirty filter	Clean filter and run jet pump
	Excessive oils / organic matter	Shock spa with sanitizer
	Improper sanitization	Add sanitizer
	Suspended particles / organic matter	Adjust pH and/or alkalinity to recommended range
	Overused or old water	Drain and refill the spa
Water Odor	Excessive organics in water	Shock spa with sanitizer
	Improper sanitization	Add sanitizer
	Low pH	Adjust pH to recommended range
Chlorine Odor	Chloramine level too high	Shock spa with sanitizer
	Low pH	Adjust pH to recommended range
Musty Odor	Bacteria or algae growth	Shock spa with sanitizer – if problem is visible or persistent, drain, clean and refill the spa
Organic Buildup / Scum Ring Around Spa	Buildup of oils and dirt	Wipe off scum with clean rag – if severe, drain the spa, use a spa surface and tile cleaner to remove the scum and refill the spa
Algae Growth	High pH	Shock spa with sanitizer and adjust pH
	Low sanitizer level	Shock spa with sanitizer and maintain sanitizer level
Eye Irritation	Low pH	Adjust pH
	Low sanitizer level	Shock spa with sanitizer and maintain sanitizer level
Skin Irritation / Rash	Unsanitary water	Shock spa with sanitizer and maintain sanitizer level
	Free chlorine level above 5 ppm	Allow free chlorine level to drop below 5 ppm before spa use
Stains	Total alkalinity and/or pH too low	Adjust total alkalinity and/or pH
	High iron or copper in source water	Use a stain and scale inhibitor
Scale	High calcium content in water – total alkalinity and pH too high	Adjust total alkalinity and pH – if scale requires removal, drain the spa, scrub off the scale, refill the spa and balance the water
		Use a stain and scale inhibitor

Removing and Reseating the Pillows

You can remove the pillows for cleaning and maintenance quickly and easily. This method works for all types of pillows.

Grab the lower edge of the pillow with both hands firmly and pull up. As you do this, the pillow inserts will pop out of the holes.

Reseat the pillows by aligning the pillow inserts with the holes and striking the pillow hard enough to insert the pegs back into the holes.

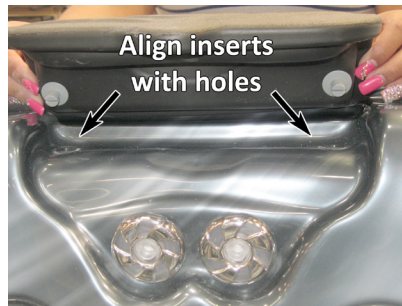

Jet Removal and Replacement

Jets can be easily removed for cleaning.

Screw-in jet removal

Grasp the outer rim of the jet and turn it counter-clockwise. The jet will unscrew from the fitting until it is free.

To replace the jet, place it in the fitting and turn it clockwise until it is snug in place and it can be rotated freely about half a turn. Do not overtighten the jet.

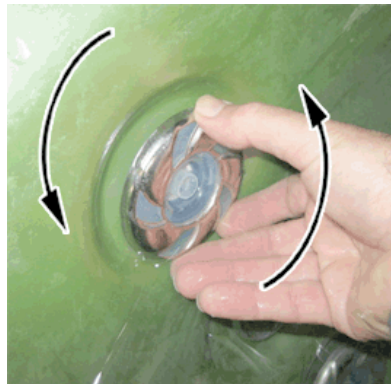

Snap-in SQR jet removal

Grasp the outer rim of the jet and turn it counter-clockwise until it completely stops. You may feel it slightly loosen pop out a bit from the fixture. Pull the jet out from the jet fixture. The jet will be very snug and may require some force to remove it. DO NOT PRY OUT JETS.

To replace any jet, place it in the fitting and turn it clockwise until it snaps in and can be rotated freely about half a turn. Do not overtighten the jet.



Draining Your Portable Spa

Your spa should be drained every four to six months for cleaning and maintenance and refilled with fresh tap water. See page 53 for instructions on cleaning the shell, cover, and pillows. See page 7 for instructions on refilling your spa. Before you begin, turn off power to the spa at the breaker and remove all filters.

1. Locate your drain.

For spas with drain inside the spa

Using a Phillips screwdriver, remove the screws to the access panel and open it. Locate hose ending with the $\frac{3}{4}$ inch hose-bib fixture as shown below.



For spas with cabinet-mounted drain

Pull the knob out of the cabinet. The cabinet drain is screwed into the drain pull knob.



2. Remove the cap.

Make sure the valve is in the closed position, then unscrew and remove the cap. Unscrew the cap.

For spas with drain inside the spa

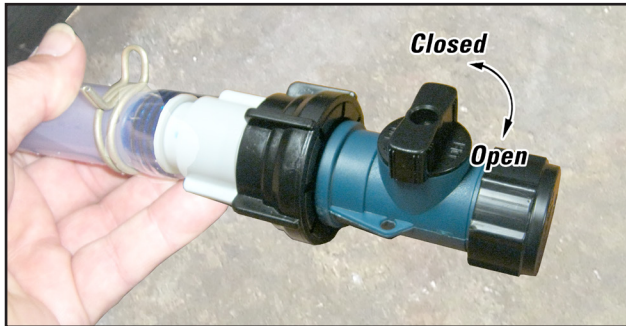

For spas with cabinet-mounted drain



3. Connect valve to a garden hose.

Attach a garden hose to the hose-bib fixture. Place the other end of the garden hose where you would like the water to drain.

4. Drain the spa.

Turn the valve on the hose-bib fixture to open the drain. When the spa has drained completely, turn the valve on the hose-bib fixture, remove garden hose, and replace the cap.

For all spas

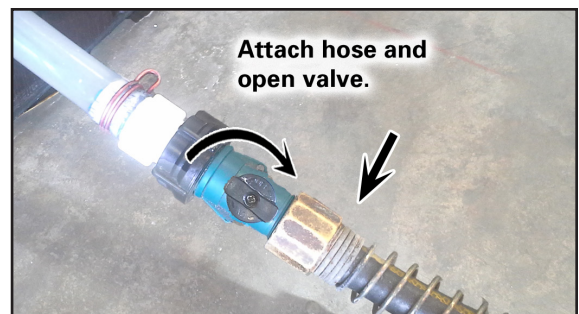

Winterizing (Cold Climate Draining)

In many areas of the country, the temperature drops below 32°F (0°C). We recommend that you always have your spa full of water and running at normal spa temperatures (80°F to 100°F, 26.7°C to 37.8°C). This will help reduce the risk of freezing in your spa and your spa's equipment.

Warning: If you find the need to drain your spa, be aware of the potential of freezing in your spas equipment and plumbing. Even if the directions below are followed perfectly, there is no guarantee that your spa will not suffer freeze damage. Freeze damage is not covered by your warranty.

1. Remove the filter baskets and filters.
2. Drain your spa completely as described in the instructions above.
3. Vacuum water from the spa's main drain and from the jets with a wet/dry vacuum.
4. Open the bleeder valves on the pumps.
5. Disconnect the unions from both sides of all pumps.
6. Blow any remaining water out of the jets and equipment area with the wet/dry vacuum.
7. When the spa has completely finished draining, close the bleeder valves and re-connect the unions on all pumps. Replace the filters and filter baskets.
8. Cover your spa with a good spa cover and an all-weather tarp to ensure that neither rain nor snow enters the spa.

Cleaning and Replacing the Filter

Filtration is one of the most important steps you can take to ensure clean, clear water. It is far less expensive to fix water clarity problems by filtering your spa than by using excessive amounts of chemicals, excessive filtration times, or by water replacement.

See the section "Cleaning the Filter" on page 43 for more information.

Set the spa in CLEAN FILTER MODE before you remove the filter. CLEAN FILTER MODE pauses all spa operations for service functions like cleaning or replacing the filter. See page 34 for instructions on using CLEAN FILTER MODE.

1. Remove the filter by unscrewing it and pulling it up and out.
2. Place the dirty filter into a bucket of water deep enough to cover the filter. Add 8 oz. of liquid filter cleaner to the bucket of water.

Note: It is a good idea to keep a spare filter to use in the spa while the dirty filter is being deep cleaned. This way, you can rotate the filters and both will last longer.

3. Soak the filter for a minimum of 24 hours.
4. Spray the filter with a water hose. Spray each pleat carefully.
5. Reinstall the filter. Do not overtighten.

Spa Cover and Locking System

Important! Keep the spa covered when not in use!

- Covered spas will use less electricity in maintaining your set temperature.
- Covering your spa will protect your spa's finish from the sun's ultraviolet rays.
- You are required to keep the spa covered to maintain warranty coverage.

- Covering your spa helps prevent children from drowning in the spa.

In addition, while the spa cover is rigid, it is not designed to support any weight. Therefore, as a safety precaution and to preserve the life of your cover, you must not sit, stand, or lie on it, nor should you place objects of any kind on top of it.



IMPORTANT! LOCKING HARDWARE ENCLOSED Parts Installation Instructions:

- 1.- Place cover on spa. Be sure it is correctly positioned.
- 2.- Position the tie-down hardware (attached to the straps of your cover) on the side of the spa so they are easily reached by the cover tie-downs straps.
- 3.- With the straps pulled taut (not overly tight) mark the location for screw placement.
- 4.- Attach hardware with the screws provided.
- 5.- Keep cover fastened down at all times when not in use. Locking hardware may be locked with a key (provided).

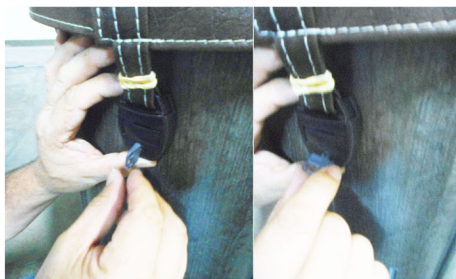

**UNLOCKED
POSITION**

**LOCKED
POSITION**



**WARNING
AVOID
DROWNING
RISK**

FAILURE TO FOLLOW INSTRUCTIONS MAY RESULT IN INJURY OR DROWNING
NON-SECURED OR IMPROPERLY SECURED COVERS ARE A HAZARD.
REMOVE COVER COMPLETELY BEFORE ENTRY OF BATHERS.
ENTRAPMENT POSSIBLE.
KEEP COVER ON SPA AND LOCKED WHEN NOT IN USE

Vacation Care

You can leave your spa unattended for up to two weeks if you follow these instructions.

ALWAYS lock your cover using the cover locks if you plan to be away from home and the spa is filled with water.

1. Select the Low Range temp choice used for vacation mode.
2. Following the water quality instructions starting on page 38, adjust the pH.
3. Shock the water (add either chlorine or bromine sanitizer).
4. When you return, check and adjust the pH and shock the water.

If you will not be using your spa for longer than 14 days and a spa maintenance service is not available, we strongly recommend you drain or winterize your spa.

Cleaning Your Spa

Spa Cover and Pillows

Due to the constant punishment your spa cover and pillows receive, you should protect them by applying a vinyl and leather cleaner as part of your monthly maintenance plan. Use a product that is specifically designed to protect spa covers and pillows from chemical and ultraviolet light damage without leaving an oily residue behind that is normally associated with common automotive vinyl protectants.

Warning: Do not use automotive vinyl protectants on spa covers or pillows. These products are generally oil-based and will cause severe water clarity issues that are difficult to correct.

Spa Shell



Each time you drain your spa, before you refill it you should clean your spa shell with an all-purpose cleaner and apply a coat of surface protectant.

Use a low detergent, non-abrasive cleaner specifically formulated to clean the spa without damaging its acrylic finish.

Use a non-oil based surface protectant that is specifically formulated to protect the spa's finish from the chemicals and minerals associated with normal spa use.

Appendix

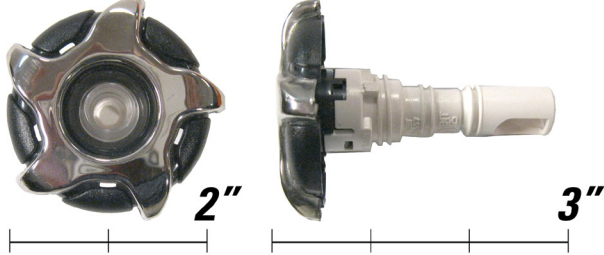
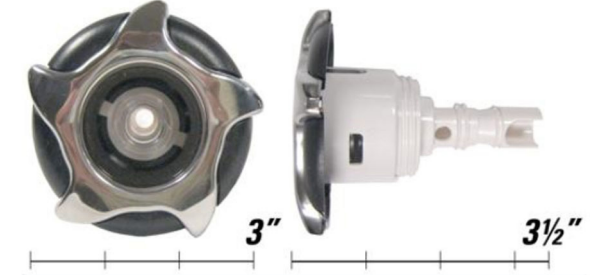

Replacement Parts

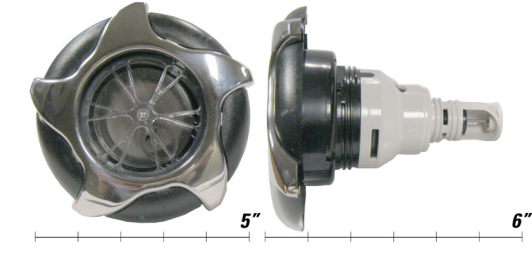
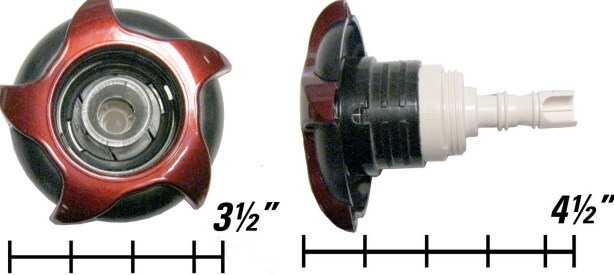
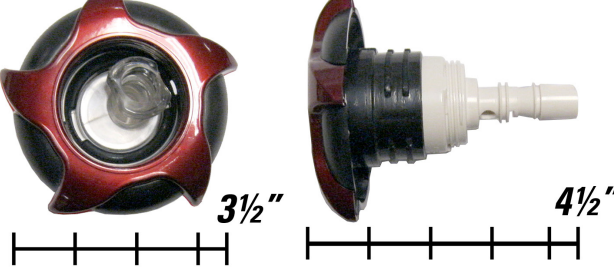

Jet Inserts	
Description	Used by
CAL SPAS Jet Insert (Ed) 2" Euro Directional Threaded Star Fire-Black PLUCS2295461SL 	Special Edition LESG
CAL SPAS Jet Insert (Mfd) 3 Inch Micro Flow Directional Threaded Star Fire - Black PLUCS2296801SL 	Special Edition LESG
CAL SPAS Jet Insert (Med) 3 Inch Micro XL Directional Threaded # Star Fire - Black PLUCS2295441SL 	Special Edition LESG

Jet Inserts	
Description	Used by
CAL SPAS Jet Insert (Pst) 5" Power Storm Wagon Wheel Threaded, Star Fire - Black PLUCS2295591SL 	Special Edition LESG
Jet Insert Red Starfire (MFD) 4" Poly Storm Direct -Threaded PLUCS2294101CAR-8 	Special Edition LESG
CAL SPAS Jet Insert Red Starfire Poly Storm, Roto PLUCS2294141CAR-8 	Special Edition LESG

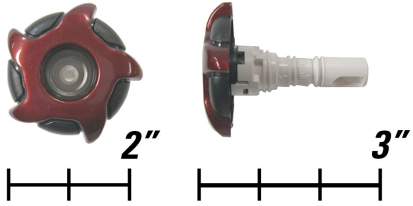
Note: All Cal Spa models use a combination of screw-in and snap-in jet inserts where removable jets are used.

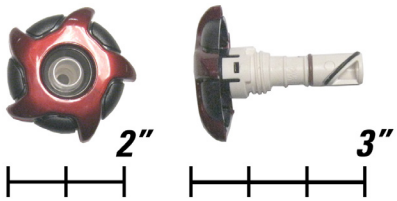
Please visit www.quickspaparts.com to order your replacement parts.

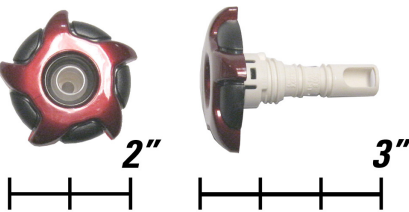
Jet Inserts	
Description	Used by
<p>CAL SPAS Jet Insert Red Starfire [ELE] 2" Cluster Storm No Eyeball PLUCS2295431CAR-8</p> 	<p>Special Edition LESG</p>
<p>PSTR 5" Power Storm Twin Roto PLUCS2295441CAR-8</p> 	<p>Special Edition LESG</p>
<p>CAL SPAS Jet Insert Red Starfire 2" Neck Jet Direct - Threaded PLUCS2295451CAR-8</p> 	<p>Special Edition LESGs</p>

Jet Inserts	
Description	Used by
<p>CAL SPAS Jet Insert Red Starfire (ED) 2" Cluster Storm Direct - Threaded PLUCS2295461CAR-8</p> 	<p>Special Edition LESGs</p>
<p>Jet Insert Red Starfire (Psr) 5" Power Storm Riffled Treaded PLUCS2295511CAR-8</p> 	<p>Special Edition LESGs</p>

If you need jet bodies, go to www.quickspaparts.com or refer to the Cal Spa Replacement Parts Catalog, which can be downloaded from www.calspas.com/replacementparts.

Please visit www.quickspaparts.com to order your replacement parts.

Jet Inserts	
Description	Used by
<p>CAL SPAS Jet Insert Red Starfire 5" Power Storm Wagon Wheel -Threaded</p> <p>PLUCS2295591CAR-8</p> 	<p>Special Edition LESGs</p>

Water Diverter Valves	
<p>CAL SPAS Diverter Valve 2" Assembly, Handle Starfire - Black/ Titanium</p> <p>PLU21300468</p> 	
Air Diverter Valves	
<p>CAL SPAS Air Control 1" T/A, Handle Star Fire - Black/ Titanium</p> <p>PLU21300526</p> 	

Pillows	
<p>Y Pillow recess</p> <p>ACC01401101</p> 	

Filters	
<p>50 sq ft</p>	<p>FIL50-5D13H15FCT-3</p> 

Teleweir Skimmers	
<p>50 square foot teleweir skimmer:</p>	
<p>Filter attaching cap assembly</p> <p>FIL11700013</p>	
<p>Filter skimmer inner pipe</p> <p>FIL11700012</p>	

Please visit www.quickspaparts.com to order your replacement parts.

LED Lights	
1-LED light string LIT16100330	
2-LED light string LIT16100331	
4-LED light string LIT16100332	
1 to 3 ext. cord LIT16100335	
1 to 1 port ext. cord LIT16100338	
Interior light with logic (7 LED) LIT16100333	

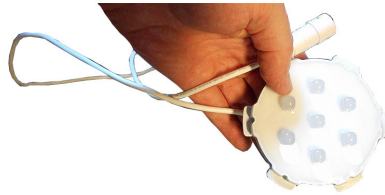
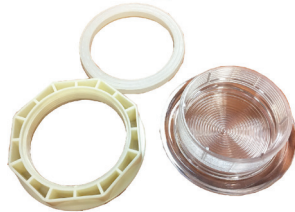
LED Lights	
Interior light without logic (7 LED) LIT16100337	
Main light housing, LED lens, fitting nut LIT16100336	

Replacement Cabinet Panels

The complete selection of replacement cabinets for all models is very extensive and too lengthy for this owner's manual. To order replacement panels for your spa, visit www.quickspaparts.com.

If you need jet bodies, go to www.quickspaparts.com or refer to the Cal Spa Replacement Parts Catalog, which can be downloaded from www.calspas.com/replacementparts.

Covers

All spa covers are designed with a tapered height, angling downward from the center to the sides to drive off rain and prevent water from pooling. The covers listed below are filled with either 1.5 lb or 2.0 lb foam.

Standard

4" - 2.5"

1.5 Lb. foam

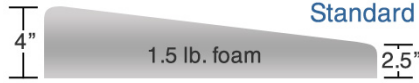

Standard

Deluxe

5" - 3"

2.0 Lb. foam

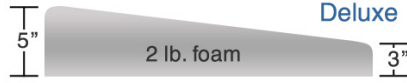

Deluxe

	Gray Standard	Gray Deluxe	Slate Standard	Slate Deluxe
93" x 130" Fits spa model: EC-947E	N/A	COV93130D53G-CC-2	N/A	N/A
84" x 84" (7 foot spas) Fits spa models: P2-722L, P2-722B, PP-732L+, PP-732B+, EC-735L, EC-735B, EC751L, EC751B, EP-761L, EP-761B, PL-760L, PL-760B, PPL7L+	COV8484S53G-CC-2	COV8484D53G-CC-2	COV8484S53S-WN-2	COV8484D53S-WN-2

Basic Troubleshooting

The troubleshooting guidance provided here is intended to cover the most common problems a spa owner may encounter. For more in-depth troubleshooting, go to www.calspas.com/troubleshooting.

Symptom	Possible Solutions
---------	--------------------

Problems starting up

Pump won't prime	See priming instructions on page 10.
Breaker keeps shutting off	Reset the GFCI breaker. If this continues, contact your dealer or a qualified spa technician.

Power and system problems

System won't start up or breaker keeps shutting off	Power may be shut off. Turn on GFCI circuit breaker. If this continues, contact your dealer or a qualified spa technician.
Control panel doesn't respond	Turn on or reset the GFCI circuit breaker. If this does not solve the problem, contact your dealer or a qualified spa technician. If you hear the pump running but the control panel doesn't respond, contact your dealer
Spa does not turn off	Spa may be trying to heat up. Check if spa is in Ready or Rest mode. In cold climates, if spa is not equipped with full foam or any kind of insulation, it will try to maintain the set temperature. Set the spa to low temperature range and set the temperature to 80°F. Spa may be in filter cycle. If it is, this is normal and no adjustment is necessary.
Message on the control panel	There may be a problem. See Error Screens on page 29.

Heat problems

Spa water does not get hot	Spa may be in low temperature range. Set the spa to high temperature range. The filter may be dirty or may need to be replaced. Clean or replace the filter. The water level may be too low. Fill the spa with water level at 4 to 6 inches from the top. The temperature is not turned up high enough. Raise temperature on topside control. Cover the spa. The cover will keep heat in the spa and help keep heat from escaping. Make sure cover is on at all times when spa is not in use. The heater element may be old, deteriorated, coated with scale, or defective. Contact your dealer for more assistance. The gate valves may be partially or completely closed. NEVER OPERATE YOUR SPA WITH THE GATE VALVES CLOSED!
----------------------------	---

If you need jet bodies, go to www.quickspaparts.com or refer to the Cal Spa Replacement Parts Catalog, which can be downloaded from www.calspas.com/replacementparts.

Symptom	Possible Solutions
Spa overheats - temperature greater than 110°F / 43°C	<p>Overheating can occur during summer months and may not necessarily indicate a malfunction. When it occurs, a message code may also appear on the control panel.</p> <p>Temperature may be set too high. Turn the set temperature down to a lower temperature.</p> <p>Filtration time may be too long. Turn the filtration cycles down during the warm months.</p> <p>The spa may not be properly ventilated. Make sure the front of the spa is not blocked to allow air flow.</p> <p>High speed pumps may have been running too long. Limit pump running time to no more than 15 to 30 minutes.</p>

Water pressure problems

Low water pressure	<p>Jet valves may be partially or fully closed. Open the jet valves.</p> <p>Filter cartridge may be dirty. Clean or replace the filter.</p> <p>Pump may have airlock. Remove airlock by priming spa (page 10)</p> <p>The suction fittings may be blocked. Remove any debris that may be blocking them.</p> <p>The filter skimmer may be blocked. Remove the blockage.</p> <p>Gate valves may be closed. Open gate valves. Note: Never operate your spa with the gate valves closed!</p> <p>Spa may be running in filtration mode. Press JETS or JETS 1 button to turn on high speed pump.</p>
No water pressure (no water stream from any jets)	<p>Power may be switched off. Turn the power back on.</p> <p>The pump may be defective. After you have tried all other troubleshooting, contact your dealer for assistance.</p>
Jets surge on and off	Water level may be too low. Add water to normal level.

Pump problems

Pump runs constantly – will not shut off	There may be a problem with circuit board. Contact your dealer.
Noisy pump	<p>The water level may be too low. Fill the spa with water level at 4 to 6 inches from the top.</p> <p>Filter cartridge may be dirty. Clean or replace the filter.</p> <p>Pump may have airlock. Remove airlock by priming spa (page 10)</p> <p>The suction fittings may be blocked. Remove any debris that may be blocking the suction fittings.</p> <p>Gate valves may be closed. Open gate valves. Note: Never operate your spa with the gate valves closed!</p> <p>Air may be leaking into the suction line. Contact your dealer for assistance.</p> <p>Debris may be inside the pump. Contact your dealer for assistance.</p> <p>Noise may be a sign of damage. Contact your dealer for service.</p>

Symptom	Possible Solutions
Pump turns off during operation	Automatic timer may have completed its cycle. Press JETS or JETS 1 button to start the cycle again. Pump may have overheated due to the vents on the equipment door being blocked. Make sure the front of the spa is not blocked to allow air flow. The pump motor may be defective. Contact your dealer for assistance.
Pump has a burning smell while running	A burning smell may be a sign of damage. Contact your dealer for service.
Pump does not run	Pump may have over heated. Let it cool for an hour and try operating the spa for a shorter time. Power to the spa may be shut off. Turn on or reset the GFCI circuit breaker. If this does not solve the problem, contact your dealer or a qualified spa technician.

“Thermal Creep”

Cal Spas are designed with energy-efficient components and systems that are meant to sustain heat generated by the equipment, which is then cycled back into the spa water. In hot weather or in situations where the spa is set to extended run times, Thermal Creep may occur. Thermal Creep is a condition where the measured water temperature can be higher than the set temperature. To manage Thermal Creep you may:

Vent your cover. This means placing a folded cloth about $\frac{3}{4}$ " (2cm) thick under all four corners of the cover before you lock the cover down.

Open your cover. Opening the cover at night will also quickly cool the water down if desired.

Open all air controls. Set your filtration cycles to run during the cooler times of the day or night.

Reduce the length of your filter cycles.

Visit your local dealer for additional guidance.

Since Thermal Creep only occurs in well-insulated hot tubs, it is not indicative of something that is wrong with your spa or its equipment.

LIMITED WARRANTY

This Limited Warranty is extended to the original purchaser of a Cal Spa brand portable spa manufactured after January 1, 2019 and installed for residential use in the United States of America and Canada. This warranty begins on the date of delivery of the spa, but in no event later than one year from the date of manufacture.

This warranty applies only to the LES -G Spas line:

Shell Structural

Warranted against water loss due to defects in the spa shell.

2 years

Shell Finish

Warranted against blistering, cracking, or delaminating of the interior surface of the spa shell.

2 years

Equipment and Controls

Electrical equipment components – specifically limited to the pumps, standard titanium heater, and control system – are warranted against malfunctions due to defects in workmanship or materials.

2 years

Plumbing

Warranted against leaks due to defects in workmanship or materials.

1 year

Cabinet - Synthetic or Fiberglass

Warranted against defects in workmanship or materials. Normal wear and weathering of the finish will occur naturally over time and are not defects.

1 year

Warranties for Other Components

The fuses, headrests, cabinet finish, and filters are warranted to be free of defects in workmanship and material at the time of delivery. All stereo-related components (receiver, speakers, sub-woofer, stereo media locker, power supply, wireless remote control etc.) are warranted against malfunction due to defects in workmanship or material for one year from the original date of delivery. All other factory-installed components not mentioned specifically, including, but not limited to the wood frame, jets, diverter valves, LED lighting systems, filter lids, and mechanical components, are warranted against malfunction due to defects in workmanship and material for two years from the original date of delivery. The spa cover delivered with the spa is warranted for 90 days.

Genuine Cal Spas Parts & Accessories

This Limited Warranty is void if Cal Spas (the "Manufacturer") or its designated representative determines that the spa has been subjected to damage or failure due to installation of aftermarket parts that are not genuine Cal Spas branded parts and accessories. This disclaimer includes, but is not limited to filters, ozone systems, salt systems, repair parts and other accessories. Genuine Cal Spas brand parts and accessories are built to our highest standards of quality, durability and performance, and they are designed to work with your spa to ensure optimal performance and function.

Performance

This warranty begins on the date of delivery of the spa, but in no event later than one year from the date of manufacture.

To obtain service in the event of a defect covered by this Limited Warranty, notify your Cal Spa dealer or Cal Spas as soon as possible and use all reasonable means to protect the spa from further damage. Upon proof of purchase, a designated service representative will correct the defect subject to the terms and conditions contained in this Limited Warranty. There will be no charge for parts or labor to repair the defect, although providing access to affect the repair is your responsibility as the spa owner. Freight charges for replacement parts is the responsibility of the spa owner. You may be assessed reasonable repairman travel mileage charges.

In the event that the spa is removed to a repair facility for repair and reinstalled, the cost of removal and reinstallation will be your responsibility as the spa owner. If the Manufacturer determines that repair of the covered defect is not feasible, it reserves the right to provide a replacement spa instead. In such an event, reasonable costs for removal of the original

spa, shipping costs from the factory for the replacement spa and delivery and installation of the replacement will be your responsibility as the spa owner. The replacement spa will carry the balance of the original spa's warranty. Spa covers are not included.

This warranty ends either by specified time frame, owner-transfer, relocation, or installation of any component other than by manufacturer.

Warranty Limitations

This Limited Warranty is void if Cal Spas or its designated representative determines that the spa has been subjected to alteration, neglect, misuse or abuse, or freight damage caused by the common carrier; any repairs have been attempted by anyone other than a designated representative; the failure is caused by accident, acts of God or other causes beyond the control of the Manufacturer; neglect, misuse and abuse include any installation, operation or maintenance of the spa other than in accordance with the instructions contained in the owner's manual provided with the spa, including but not limited to the failure to maintain proper water chemistry and chemical balance and the use of abrasive or improper cleaners or non-genuine parts and accessories. This Limited Warranty does not provide coverage for any item attached to or installed on the spa after the date of manufacture or for gaining access to any component for repair or replacement. Spa units in commercial use are excluded from any coverage whatsoever. The spa owner accepts liability for repair work performed by anyone other than the Manufacturer or a designated Cal Spa representative. This Limited Warranty is void if damage occurs to the spa shell because of excessive heat buildup due to failure to cover a spa that is empty of water while exposed to direct sunlight.

Limitations

The Manufacturer disclaims all warranties, expressed or implied, in fact or in law, to the extent allowed by your State's Law, including the warranty of merchantability and fitness for use, except as stated specifically herein. All warranty service must be performed by the Manufacturer or its designated representative using authorized Cal Spa parts. No agent, dealer, distributor, service company or other party is authorized to change, modify or extend the terms of this limited warranty in any manner whatsoever. The Manufacturer will not be responsible for any statements or representations made in any form that go beyond, are broader than, or are inconsistent with any authorized literature or specifications furnished by Cal Spas.

Disclaimers

The Manufacturer and its representatives shall not be liable for any injury, loss, cost or other damage, whether incidental or consequential, arising out of any defect covered by this limited warranty, including without limitation, loss of use of the spa and cost for removal of defective product even if the Manufacturer was advised of the possibility of damage. The liability of the Manufacturer under this limited warranty, if any, shall not exceed the original amount paid for the defective product. Coverage under this limited warranty shall commence as of the original date of delivery and the duration of such coverage shall not extend for any reason whatsoever beyond the stated time periods. These disclaimers shall be equally applicable to any service provided by the Manufacturer and its designated representatives.

Legal Rights

This Limited Warranty gives you specific legal rights. You may also have other rights that vary from state to state. Some states do not allow limitations on how long an implied warranty lasts, so this limitation may not apply to you.

If you need jet bodies, go to www.quickspaparts.com or refer to the Cal Spa Replacement Parts Catalog, which can be downloaded from www.calspas.com/replacementparts.

Warranty Registration

Registering your new Cal Spas product is quick and easy. It is important that you register your Cal Spas product as soon as possible. By taking just a few quick minutes to register, you can enjoy product alerts, more efficient support, and quicker service.

Go to www.calspas.com/warranty. Fill in your information and click "Send Warranty Info"

Locating the product serial number: The serial number of your spa is located on a metal plate attached to the inside of the door for the equipment area. You will need this number to properly register your spa and activate coverage. Write this information in the space provided below.

Spa Model: _____

Spa Serial Number: _____

Date Purchased: _____

Date Installed: _____

Dealer's Phone Number: _____

Dealer's Address: _____

**Please visit www.quickspaparts.com to
order your replacement parts.**

LTR20191164, Rev. A
11/20/19