

# CalSpas®

## OWNER'S MANUAL

2019

UK

- Veranda
- Patio & Patio Plus
- Escape & Escape Plus
- Special Edition



2631-16-E

[www.calspas.com](http://www.calspas.com)

# Table of Contents

<b>Important Safety Instructions . . . . .</b>	<b>1</b>	<b>Generic Names for Chemicals . . . . .</b>	<b>78</b>
<b>Preparing for Your New Portable Spa . 2</b>		<b>Common Water Chemistry Questions . . . .</b>	<b>79</b>
<b>Pre-Delivery Checklist . . . . .</b>	<b>2</b>	<b>Do's and Don'ts . . . . .</b>	<b>80</b>
<b>Planning the Best Location . . . . .</b>	<b>2</b>	<b>Bather Load . . . . .</b>	<b>81</b>
<b>Preparing a Good Foundation . . . . .</b>	<b>3</b>	<b>Ozonator . . . . .</b>	<b>81</b>
<b>Opening the Front Door Panel for Electrical</b>		<b>Troubleshooting Water Clarity Problems . .</b>	<b>82</b>
<b>Hookup . . . . .</b>	<b>3</b>	<b>Bromine Generator . . . . .</b>	<b>83</b>
<b>240 Volt Electrical Installation . . . . .</b>	<b>4</b>	<b>Intelligent Controller Codes for the Bromine</b>	
<b>Wiring Requirement/50 Hz. . . . .</b>	<b>5</b>	<b>Generator . . . . .</b>	<b>84</b>
<b>European Wiring Configuration . . . . .</b>	<b>6</b>	<b>Cleaning and Maintenance / Using Sound</b>	
<b>Testing the 240 Volt GFCI Breaker . . . . .</b>	<b>7</b>	<b>System . . . . .</b>	<b>85</b>
<b>Filling and Powering Up Your Portable Spa</b>	<b>7</b>	<b>Removing and Reseating the Pillows . . . .</b>	<b>85</b>
<b>Priming the Pump . . . . .</b>	<b>9</b>	<b>Jet Removal and Replacement . . . . .</b>	<b>85</b>
<b>Operating Your Spa . . . . .</b>	<b>11</b>	<b>Draining Your Portable Spa . . . . .</b>	<b>86</b>
<b>spaTouch . . . . .</b>	<b>11</b>	<b>Winterizing (Cold Climate Draining) . . . .</b>	<b>87</b>
<b>TP600/TP400 . . . . .</b>	<b>43</b>	<b>Cleaning and Replacing the Filter . . . . .</b>	<b>87</b>
<b>Jets . . . . .</b>	<b>68</b>	<b>Spa Cover . . . . .</b>	<b>88</b>
<b>ATS Plus Therapy System . . . . .</b>	<b>69</b>	<b>Vacation Care . . . . .</b>	<b>88</b>
<b>Aquatic Air Therapy™ (AAT) . . . . .</b>	<b>70</b>	<b>Cleaning Your Spa . . . . .</b>	<b>89</b>
<b>LED Lighting . . . . .</b>	<b>70</b>	<b>Using the Freedom Sound System . . . . .</b>	<b>89</b>
<b>Diverter Knobs . . . . .</b>	<b>71</b>	<b>Appendix . . . . .</b>	<b>90</b>
<b>Air Venturis . . . . .</b>	<b>71</b>	<b>Replacement Parts . . . . .</b>	<b>90</b>
<b>Waterfalls . . . . .</b>	<b>71</b>	<b>Basic Troubleshooting . . . . .</b>	<b>103</b>
<b>Hydro Streamer Waterfall . . . . .</b>	<b>71</b>	<b>"Thermal Creep" . . . . .</b>	<b>105</b>
<b>Water Clarity . . . . .</b>	<b>72</b>	<b>Limited Warranty . . . . .</b>	<b>106</b>
<b>Water Quality Terms and Definitions . . . .</b>	<b>72</b>	<b>Warranty Registration . . . . .</b>	<b>114</b>
<b>Water Testing Methods . . . . .</b>	<b>73</b>		
<b>Adding Chemicals to the Spa Water . . . . .</b>	<b>74</b>		
<b>1. Balancing the Water Chemistry Levels . 74</b>			
<b>2. Sanitation and Shock . . . . .</b>	<b>76</b>		
<b>3. Filtration . . . . .</b>	<b>77</b>		
<b>4. Regularity (Maintenance Schedule) . . . .</b>	<b>78</b>		

Copyright 2019 LMS. All rights reserved. Duplication without written consent is strictly prohibited.

Cal Spas® and Freedom Sound System™ are registered trademarks.

Due to continuous improvement programs, all models, operation, and/or specifications are subject to change without prior notice.

LTR20191035, Rev. E  
7/5/19

## CONTACT INFORMATION

For customer service, please contact your authorized dealer immediately. If you need additional information and/or assistance, contact:

**LMS Customer Service Department**  
**1462 East Ninth Street**  
**Pomona, CA 91766.**

Toll Free: 1-800-CAL-SPAS  
Fax: 1-909-629-3890

# Important Safety Instructions

## READ AND FOLLOW ALL INSTRUCTIONS.

### **DANGER -- Risk of accidental drowning:**

Do not allow children to be in or around a spa unless a responsible adult supervises them. Keep the spa cover on and locked when not in use. See instructions enclosed with your cover for locking procedures.

### **DANGER -- Risk of injury:**

The suction fittings in this spa are sized to match the specific water flow created by the pump. Should the need arise to replace the suction fittings, or the pump, be sure the flow rates are compatible.

Never operate the spa if the suction fitting or filter baskets are broken or missing. Never replace a suction fitting with one that is rated less than the flow rate marked on the original suction fitting.

### **DANGER -- Risk of electric shock:**

Install the spa at least 5 feet (1.5 meters) from all metal surfaces. As an alternative, a spa may be installed within 5 feet of metal surfaces if each metal surface is permanently bonded by a minimum #8 AWG solid copper conductor to the outside of the spa's control box.

Do not permit any external electrical appliances, such as lights, telephones, radios, televisions, and etc., within five feet (1.5 meters) of the spa. Never attempt to operate any electrical device from inside the spa.

Replace a damaged power cord immediately.

Do not bury the power cord.

Connect to a grounded, grounding-type receptacle only.

### **WARNING -- To reduce the risk of injury:**

The spa water should never exceed 104°F (40°C). Water temperatures between 100°F (38°C) and 104°F (40°C) are considered safe for a healthy adult. Lower water temperatures are recommended for young children and when spa use exceeds 10 minutes.

High water temperatures have a high potential for causing fetal damage during pregnancy. Women who are pregnant, or who think they are pregnant, should always check with their physician prior to spa usage.

The use of alcohol, drugs or medication before or during

spa use may lead to unconsciousness, with the possibility of drowning.

Persons suffering from obesity, a medical history of heart disease, low or high blood pressure, circulatory system problems or diabetes should consult a physician before using the spa.

Persons using medications should consult a physician before using the spa since some medications may induce drowsiness while others may affect heart rate, blood pressure and circulation.

### **HYPERTHERMIA DANGER:**

Prolonged exposure to hot air or water can induce hyperthermia. Hyperthermia occurs when the internal temperature of the body reaches a level 3°F to 6°F above the normal body temperature of 98.6°F (or 2°C to 4°C above 37°C). While hyperthermia has many health benefits, it is important not to allow your body's core temperature to rise above 103°F (39.5°C).

Symptoms of excessive hyperthermia include dizziness, lethargy, drowsiness and fainting. The effects of excessive hyperthermia may include:

- Failure to perceive heat
- Failure to recognize the need to exit spa or hot tub
- Unawareness of impending hazard
- Fetal damage in pregnant women
- Physical inability to exit the spa
- Unconsciousness

**WARNING:** The use of alcohol, drugs, or medication can greatly increase the risk of fatal hyperthermia.

**WARNING:** People with infectious diseases should not use a spa or hot tub.

**WARNING:** To avoid injury, exercise care when entering or exiting the spa or hot tub.

**WARNING:** Do not use drugs or alcohol before or during the use of a spa or hot tub to avoid unconsciousness and possible drowning.

**WARNING:** Do not use a spa or hot tub immediately following strenuous exercise.

**WARNING:** Prolonged immersion in a spa or hot tub may be injurious to your health.

**CAUTION:** Maintain water chemistry in accordance with manufacturer's instructions.

## SAVE THESE INSTRUCTIONS.

# Preparing for Your New Portable Spa

## Pre-Delivery Checklist

Most cities and counties require permits for exterior construction and electrical circuits. In addition, some communities have codes requiring residential barriers such as fencing and/or self-closing gates on property to prevent unsupervised access to the property by children. Your dealer can provide information on which permits may be required and how to obtain them prior to the delivery of your spa.

Before Delivery	
	Plan your delivery route
	Choose a suitable location for the spa
	Lay a 5 - 8 cm concrete slab
	Install dedicated electrical supply
After Delivery	
	Place spa on slab
	Connect electrical components

## Planning the Best Location

### Safety First

Do not place your spa within 10 feet (3 m) of overhead power lines.

### Consider How You Will Use Your Spa

How you intend to use your spa will help you determine where you should position it. For example, will you use your spa for recreational or therapeutic purposes? If your spa is mainly used for family recreation, be sure to leave plenty of room around it for activity. If you will use it for relaxation and therapy, you will probably want to create a specific mood around it.

### Plan for Your Environment

If you live in a region where it snows in the winter or rains frequently, place the spa near a house entry. By doing this, you will have a place to change clothes and not be uncomfortable.

### Consider Your Privacy

In a cold-weather climate, bare trees won't provide much privacy. Think of your spa's surroundings during all seasons to determine your best privacy options. Consider the view of your neighbors as well when you plan the location of your spa.

### Provide a View with Your Spa

Think about the direction you will be facing when sitting in your spa. Do you have a special landscaped area in your yard that you find enjoyable? Perhaps there is an area that catches a soothing breeze during the day or a lovely sunset in the evening.

### Keep Your Spa Clean

In planning your spa's location, consider a location where the path to and from the house can be kept clean and free of debris.

Prevent dirt and contaminants from being tracked into your spa by placing a foot mat at the spa's entrance where the bathers can clean their feet before entering your spa.

### Allow for Service Access

Make sure the spa is positioned so that access to the equipment compartment and all side panels will not be blocked.

Many people choose to install a decorative structure around their spa. If you are installing your spa with any type of structure on the outside, such as a gazebo, remember to allow access for service. It is always best to design special installations so that the spa can still be moved, or lifted off the ground.

## Preparing a Good Foundation

Your spa needs a solid and level foundation. The area that it sits on must be able to support the weight of the spa, with water and the occupants who use it. If the foundation is inadequate, it may shift or settle after the spa is in place, causing stress that could DAMAGE YOUR SPA SHELL AND FINISH.

**Damage caused by inadequate or improper foundation support is not covered by the warranty. It is the responsibility of the spa owner to provide a proper foundation for the spa.**

Place the spa on an elevated 3 to 4" / 30 cm concrete slab. Pavers, gravel, brick, sand, timbers or dirt foundations are **not** adequate to support the spa.

We strongly recommend that a qualified, licensed contractor prepare the foundation for your spa.

If you are installing the spa indoors, pay close attention to the flooring beneath it. Choose flooring that will not be damaged or stained.

If you are installing your spa on an elevated wood deck or other structure, it is highly recommended that you consult a structural engineer or contractor to ensure the structure will support the weight of 150 pounds per square foot (732 kg / m<sup>2</sup>).

To properly identify the weight of your new spa when full, remember water weighs 8.33 lbs. per gallon, or 1 kg per liter. For example, an average 8' spa holds approximately 500 gallons, or 1892 liters, of water. Using this formula, you will find that the weight of the water alone is 4,165 lbs, or 1892 kg. Combined with the dry weight of the spa you will note that this spa will weigh approximately 5,000 lbs, or 2267 kg, when full of water.



## Opening the Front Door Panel for Electrical Hookup

The following electrical connections must be performed by a licensed electrical contractor. Unscrew and remove the two corner panels on each side of the spa's front door.





Reach in and pull the drain assembly through by a few inches. Carefully unscrew the black outer drain knob and then unscrew and remove the front door panel.

Pictured to the right is the inside of the spa behind the front door. The electrician now has access to connect the spa for power. While the front door is off, refer to page 7 for instructions on ensuring the plumbing fittings are secure (but do not be tempted to over-torque or over-tighten these fittings).



Pull the drain pipe through the front door panel, reattach the black outer drain knob and pull the drain assembly back inside so that the knob is flush with the panel again. Reattach and screw panels back in. (Front door first, then corner panels)

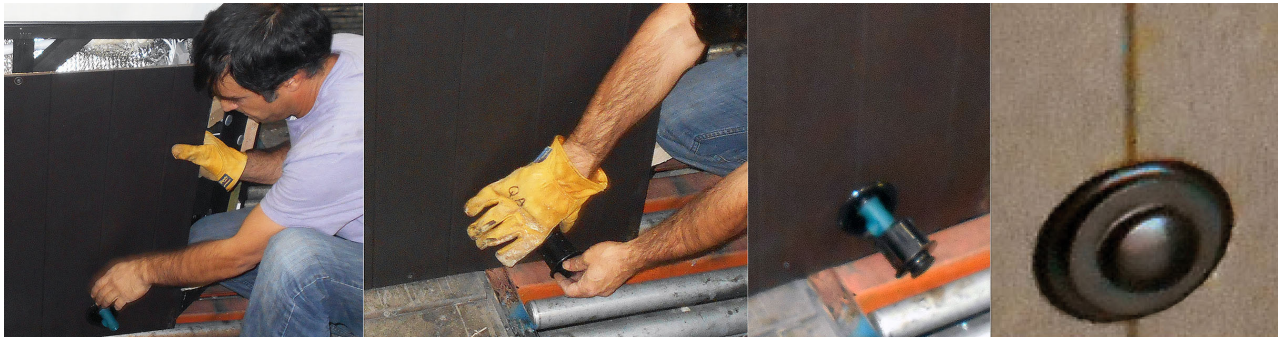

## 240 Volt Electrical Installation

All 240V spas must be permanently connected (hard wired) to the power supply. See the GFCI and wiring requirements on page 5.

**These instructions describe the only acceptable electrical wiring procedure. Spas wired in any other way will void your warranty and may result in serious injury.**

When installed in the United States, the electrical wiring of this spa must meet the requirements of NEC 70 and any applicable local, state, and federal codes.

**The electrical circuit must be installed by an electrical contractor and approved by a local building or electrical inspector.**

**Failure to comply with state and local codes may result in fire or personal injury and will be the sole responsibility of the spa owner.**

The power supplied to the spa must be on a dedicated GFCI protected circuit as required by NEC 70 with no other appliances or lights sharing the power.

Use copper wire with THHN insulation. Do not use aluminum wire.

Use the table below to determine your GFCI and wiring requirements.

Wires that run over 100 feet must increase wire gauge to the next lower number. For example: A normal 50 amp GFCI with four #6 AWG copper wires that run over 100 feet would require you to go to four #4 AWG copper wires.

# Wiring Requirement/50 Hz

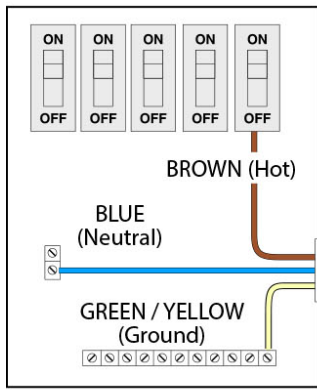

One 16A RCD

Three wires:

- 1 brown (HOT)
- 1 blue (NEUTRAL)
- 1 yellow (GROUND)

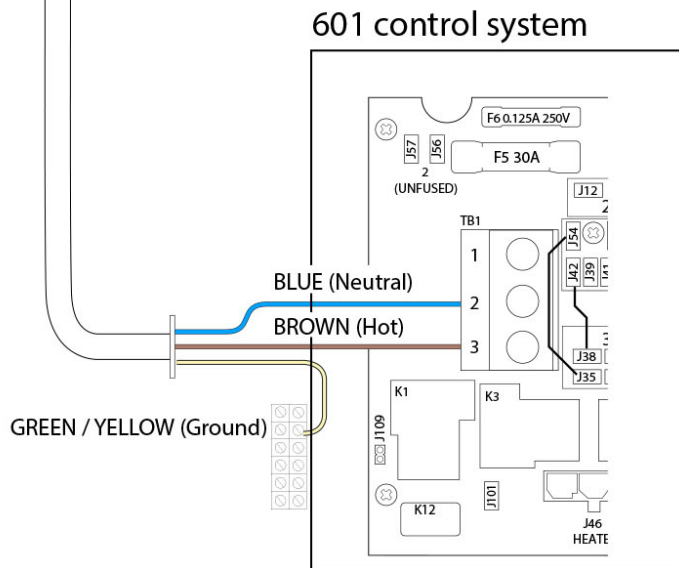
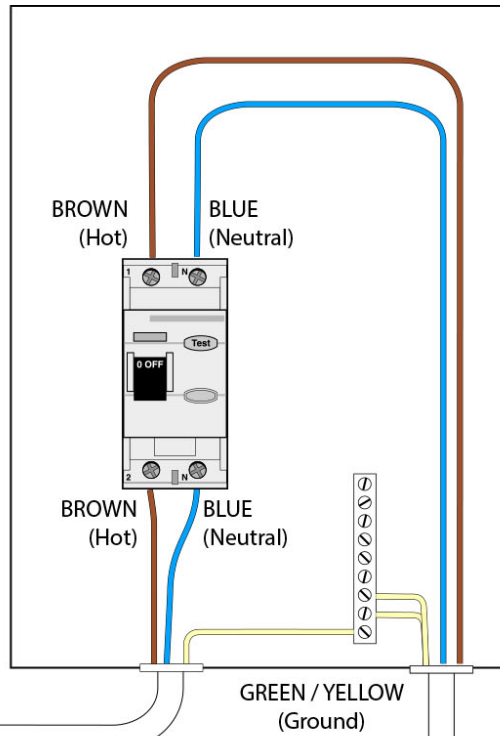

See the Cal Spas Pre-Delivery Guide for more information on spa placement for service access and electrical service.  
[www.calspas.com/manuals](http://www.calspas.com/manuals)

# European Wiring Configuration

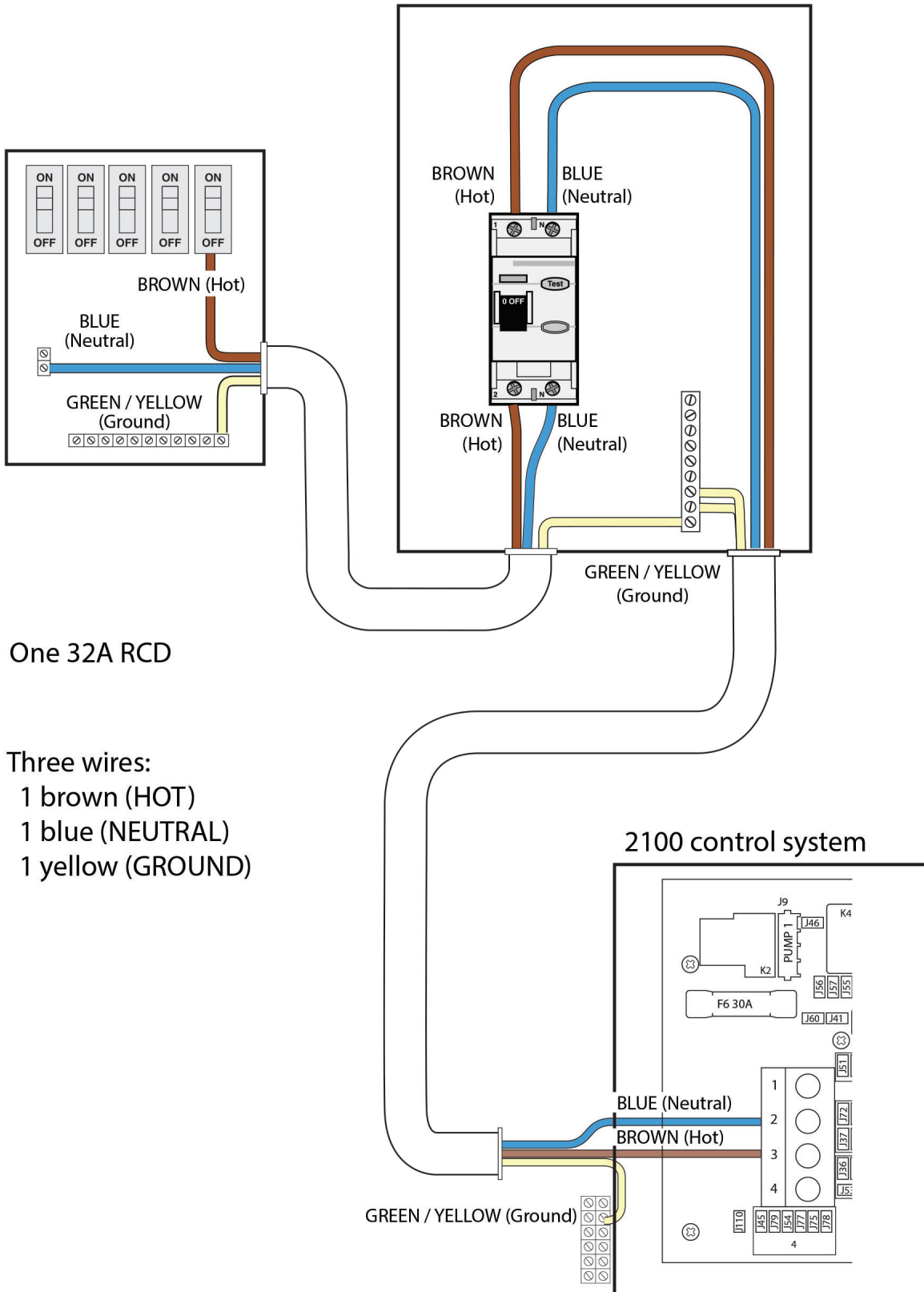

One 32A RCD

Three wires:

- 1 brown (HOT)
- 1 blue (NEUTRAL)
- 1 yellow (GROUND)



## Testing the 240 Volt GFCI Breaker

Test the GFCI breaker prior to first use and periodically when the spa is powered. To test the GFCI breaker follow these instructions (spa should be operating):

1. Press the TEST button on the GFCI. The GFCI will trip and the spa will shut off.
2. Reset the GFCI breaker by switching the breaker to the full OFF position, wait a moment, then turn the breaker back on. The spa should have power again.

## Filling and Powering Up Your Portable Spa

### 1. Inspect the spa equipment.

Inspect all plumbing connections in the equipment area of your spa.

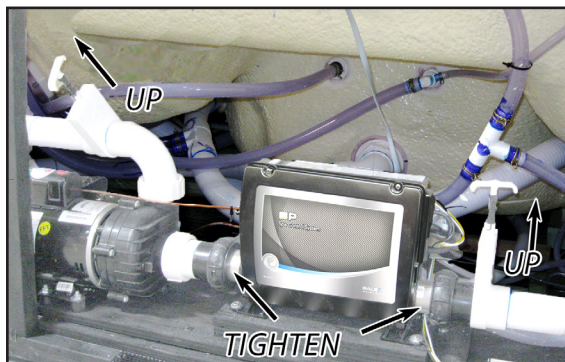

- Make sure unions in the equipment pack are tight. (Be careful not to over-tighten the plumbing fittings.)
- If your spa has gate valves, make sure they are all in the UP or OPEN position.
- Make sure the drain valve is closed and capped. (See page 86 for a description of drain valves.)

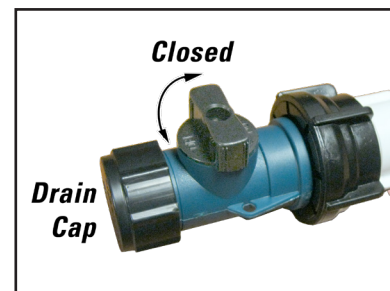

Never run the spa with the gate valves closed or without water circulating for long periods of time.

**2. Remove the cartridge from filter canister.**

**If you have a skimmer like this:**

Grip the filter by the handle and unscrew it from the canister. Never try to pull the filter cartridge while the spa is running in low or high speed (i.e., any speed).



**If you have a skimmer like this:**

Remove the black skimmer cap and barrel, grip the filter by the handle and unscrew it from the canister.



**Teleweir Mega filter skimmer**

- 75 square feet filtration
- Smooth cap

**If you have a skimmer like this:**

Rotate and remove the black locking ring. Remove the black skimmer cap and barrel, grip the filter by the handle and unscrew it from the canister.

Replace and lock the locking ring and slide the skimmer cap and barrel back in the canister.

**Note:** The skimmer cap and barrel were locked in place at the factory to prevent damage during shipment. It must be unlocked and replaced in the filter canister so that it can float when the spa is filled. If you do not remove the cap and barrel, your spa's filtration system will not perform as it was designed to.



**Teleweir filter skimmer**

- 50 square feet filtration
- Spoked cap



After you remove the filter, remove the plastic wrapper and soak it in water for 30 minutes before you replace it. A dry filter can allow air into the filtration system which can cause the pump to fail to prime.

**3. Fill the spa.**

Place a garden hose in the filter canister and fill your spa.

**Always fill the spa through the filter canister.** Failure to do so may cause air to be trapped in the filtration system and prevent the pumps from operating properly.

Fill the spa until water level is about six inches from the top.

If the water level is too low or too high, your spa will not operate properly.

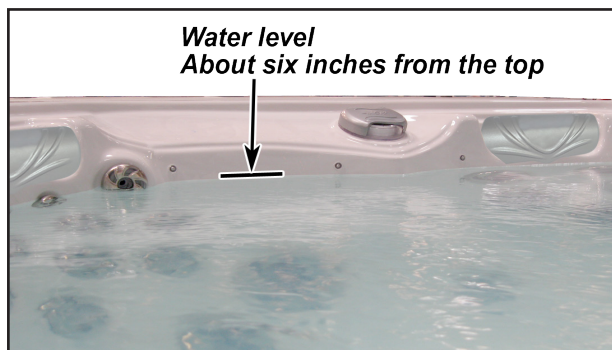

**Never fill your spa with soft water.**

Soft water makes it impossible to maintain the proper water chemistry and may cause the water to foam, which will ultimately harm the finish of the spa and void your warranty. You may fill your spa with **well water**

**provided the following conditions are met:** 1) Purchase and use a pre-filter to run the well water through on the fill-up. The pre-filter will be placed before the spa filter in the fill-up flow of water. 2) Have a Total Dissolved Solids (TDS) and metals test performed by a qualified person after the fill-up process but before any spa use.

#### 4. Turn on power to the spa.



When the spa is filled to the correct level, turn on the power at the GFCI breaker. (Ensure that the 120V spas are connected to the proper electrical outlet.)

#### 5. Install the filter into the filter canister

Make sure the filter has soaked at least 30 minutes before you install it. Insert the filter all the way and screw it in. Do not over-torque the cartridge during installation, just hand tighten gently.



#### 6. Adjust water chemistry.

Test and adjust the water chemistry. See the section on page 72 for instructions on keeping your water clear.

Spa owners with the bromine generator need to follow the instructions on page 83.

#### 7. Let the spa heat up.

When the spa has finished priming, the heater will activate. Put the cover on and let the spa heat to the set temperature.

## Priming the Pump

New spa owners often have difficulty the first time they start their spa and the pump fails to prime. This can be frustrating, but these simple instructions can help you.

Sometimes air can become trapped in the pump while filling the spa. You will know this has happened when after you have filled and started the spa, the pump does not seem to function. You will hear the pump operating, but no water will be moving.



The pump will not work properly while air is trapped in it. Continuing to operate the pump in this way will cause damage.

## Bleeding Air from the Pump

If you have tried priming the pump several times unsuccessfully using the control panel, you can bleed the air from the pump manually.

1. Shut off the power to the spa.
2. Using a Phillips screwdriver, remove the front panel from the spa and locate the pump.
3. Close the gate valve on the discharge side of the pump (if your spa is installed with one.)
4. Turn the bleeder valve counter clockwise with a small pair of pliers until the air has been released from the pump.
5. If this is unsuccessful, loosen the union nut on side of the pump with channel locks. When air is bled out, tighten the nut.
6. Turn on power to the spa and press the **JETS** button. If there is still air trapped in the pump, repeat steps 2 through 5 until the pump primes.

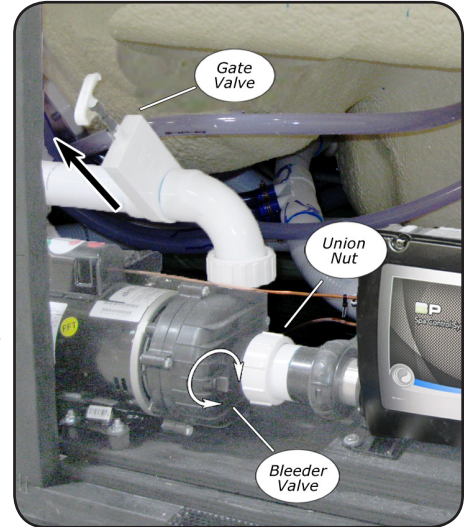

## spaTouch

### spaTouch™ Icon Driven Control Panels

#### Balboa Water Group BP Series Systems

#### User Interface and Programming Reference

The spaTouch™ Icon Driven panel is compatible with all BP systems that already support the TP800 and/or the TP900. If this panel is used with a system that supports only the TP400 and/or TP600, many screens will work correctly, and the spa screen will try to display all of your equipments, but in some cases it may not display correctly.



Manufactured under one or more of these patents. U.S. Patents: 5332944, 5361215, 5550753, 5559720, 5,883,459, 6253227, 6282370, 6590188, 6976052, 6965815, 7030343, 7,417,834 b2, Canadian Patent: 2342614, Australian patent: 2373248 other patents both foreign and domestic applied for and pending.  
42281\_A

## The Main Screen

### Spa Status

Important information about spa operation can be seen on the Main Screen.

Most features, including Set Temperature adjustment, can be accessed from this screen.

The actual water temperature can be seen, and the Set Temperature can be adjusted (see page 5).

Time-of-Day, Ozone and Filter status is available, along with other messages and alerts.

The selected Temperature Range is indicated in the upper left corner.

The Spa Equipment Control Icon will spin if any pump is running.

A Lock icon is visible if the panel or settings are locked.

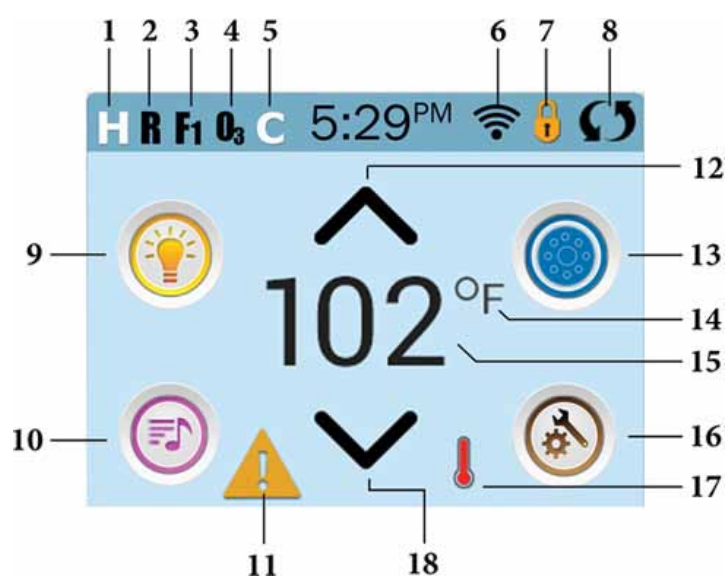

### ICON Specifications

1. H = High Temperature Range
2. R = Ready Mode
3. F1 = Filter Cycle 1 Running
4. O<sub>3</sub> = Ozone Running
5. C = Cleanup Cycle
6. Wi-Fi Signal Indicator
7. Lock Indicator Icon
8. Invert Screen
9. Light Icon = Turns On/Off
10. Music Icon = Press To Enter Music Screen
11. Message Waiting Indicator
12. Set Temperature Up
13. Spa Equipment Control Icon
14. Temperature Scale (F/C)
15. Current Water Temperature
16. Settings Icon
17. Heat Indicator
18. Set Temperature Down

Note: Refer to page 3 for additional info.

**Note: After 30 minutes\* the display will automatically go into sleep mode, which turns the display off. This is normal operation. Touch anywhere on the screen to wake the panel up.**

\*The actual number of minutes can be customized. See page 20.

Manufactured under one or more of these patents. U.S. Patents: 5332944, 5361215, 5550753, 5559720, 5,883,459, 6253227, 6282370, 6590188, 6976052, 6965815, 7030343, 7,417,834 b2, Canadian Patent: 2342614, Australian patent: 2373248 other patents both foreign and domestic applied for and pending.

42281\_A

2

11-19-15

# The Main Screen – Continued

## ICON Specifications

1. = High Temperature Range. = Low Temperature Range.
2. = Ready Mode. = Ready And Rest Mode. = Rest Mode.
3. = Filter Cycle 1 is running. = Filter Cycle 2 is running. = Filter Cycles 1 and 2 are both running.
4. = Ozone is Running. If you don't see the icon that means the Ozone is OFF.
5. = Cleanup Cycle is Running. Note: Not all systems that can run a Cleanup Cycle display this icon.
6. = Wi-Fi icon just indicates that the Wi-Fi link is connected. It does not indicate signal strength. Note: Not all systems that support Wi-Fi display this icon.
7. Lock Icon:

When displayed, indicates the panel is in a locked mode. To unlock or lock a setting or panel lock, first press the corresponding icon on the Lock Screen, then press and hold the word "Lock" for 5+ seconds until the text and icon change to the opposite state.

There are 2 lock icons that can be shown on the title bar of most screens. A tall skinny one representing a settings lock is applied. It is shown on screens that are affected by the settings lock. And the standard lock icon Padlock which represents the Panel being locked. If both settings and panel are locked, only the panel lock will show since the settings lock doesn't do much in that situation. When the panel is locked, the Settings Screen will only show items not affected by that lock (System Info and Lock Screens).

8. = Invert (or flip) Screen.
9. = Lights is turned ON. = Light is Inactive. = Light is Disabled.
10. = Music is Active. = Music is Inactive. = Music is Disabled.

### 11. Message Waiting Indicator:

The Message Waiting Indicator will show one of the following icons:

- = Fatal error (Spa can't function until it's fixed)
- = Normal Error or Warning
- = Reminder Message
- = Information Message.

Touch the Indicator to go to a Message Screen which shows the message.

Some messages will include the "Call for Service" text as it requires a service technician to fix the problem. If the panel is locked and a message alert appears, you will be taken to the Lock Screen (where you will need to Unlock the panel) before you can clear the message.

Touching the Error/Warning/Reminder/Info Icon on the Message Screen will take you to the System Information Screen to allow for troubleshooting over the phone or for a field service tech to better understand what is going on. Exiting the System information Screen will take you back to the Message Screen in that situation.

12. Adjust set temperature higher.
13. = Spa Equipment Control Icon. Brings up a screen where the spa jets, blower or other equipment can be controlled. While on the Spa Equipment Screen, you can press a Jets button once for low speed, and if configured press it again for high speed. = Jet is Inactive. Indicates if a pump is running or not.
14. Indicates if the temperature is in = Fahrenheit or = Celsius.
15. Current water temperature if or is solid; set temperature if or is flashing.
16. Setting Icon. = Settings is Active. = Settings is Inactive (when the panel is locked). Takes you to Settings Screen
17. Different animation sequences, including blinking, may indicate different stages of heating.
18. Adjust set temperature lower.

## The Main Screen – Continued

### Navigation

Navigating the entire menu structure is done by touching the screen.

The three screen selections indicated below can be selected. Touch one of these to enter a different screen with additional controls.

Most menu screens time out and revert to the main screen after 30 seconds of no activity.

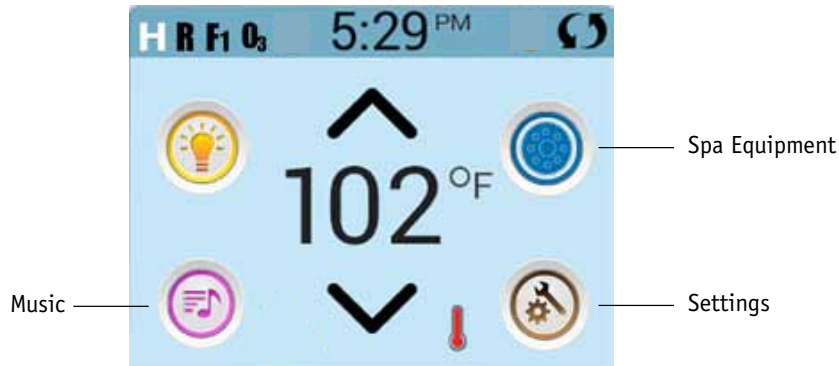

### Messages

At the bottom of the screen, at certain times an indicator may appear showing that a message is waiting. Touch this indicator to go to the Message Display Screen. On that Screen some of the messages can be dismissed. For more on the Message Display Screen, see pages 25-30.



Manufactured under one or more of these patents. U.S. Patents: 5332944, 5361215, 5550753, 5559720, 5,883,459, 6253227, 6282370, 6590188, 6976052, 6965815, 7030343, 7,417,834 b2, Canadian Patent: 2342614, Australian patent: 2373248 other patents both foreign and domestic applied for and pending.

42281\_A

4

11-19-15



# The Set Temperature

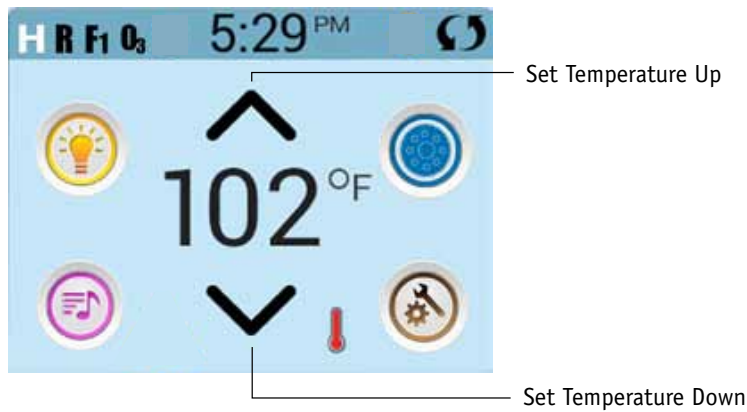

## Set Temperature

Press Up or Down once to display the Set Temperature (indicated by a flashing °F or °C, plus a change in color of the temperature). Press Up or Down again to modify the Set Temperature. The Set Temperature changes immediately.

If you need to switch between High Temperature Range and Low Temperature Range you need to go to the Settings Screen.

## Press-and-Hold

If Up or Down is pressed and held, the temperature will continue to change until you stop pressing, or until the Temperature Range limits are reached.

Manufactured under one or more of these patents. U.S. Patents: 5332944, 5361215, 5550753, 5559720, 5,883,459, 6253227, 6282370, 6590188, 6976052, 6965815, 7030343, 7,417,834 b2, Canadian Patent: 2342614, Australian patent: 2373248 other patents both foreign and domestic applied for and pending.

# The Spa Screen

## All Equipment Access

The Spa Screen shows all available equipment\* to control. The display shows icons that are related to the equipment installed on a particular spa model, so this screen may change depending on the installation.

The icon buttons are used to select and control individual devices.

Some devices, like pumps, may have more than one ON state, so the icon will change to reflect the state of the equipment. Below are some examples of 2-speed Pump indicators.



Jets Off



Jets Low



Jets High

If the Spa has a Circ Pump, a Circ Pump Icon will appear to indicate its activity, but outside of Priming Mode, the Circ Pump cannot be controlled directly.



\*One exception: The Main Spa Light is not shown on the Spa Screen; it is only shown (and controlled) on the Main Screen.

Manufactured under one or more of these patents. U.S. Patents: 5332944, 5361215, 5550753, 5559720, 5,883,459, 6253227, 6282370, 6590188, 6976052, 6965815, 7030343, 7,417,834 b2, Canadian Patent: 2342614, Australian patent: 2373248 other patents both foreign and domestic applied for and pending.

42281\_A

6

11-19-15

# Common Buttons

## Values Increment/Decrement

If an Up or Down button is shown and pressed when on an editing page, and a value has been selected (highlighted), the value can be incremented by pressing the up arrow or decremented by pressing the down arrow.

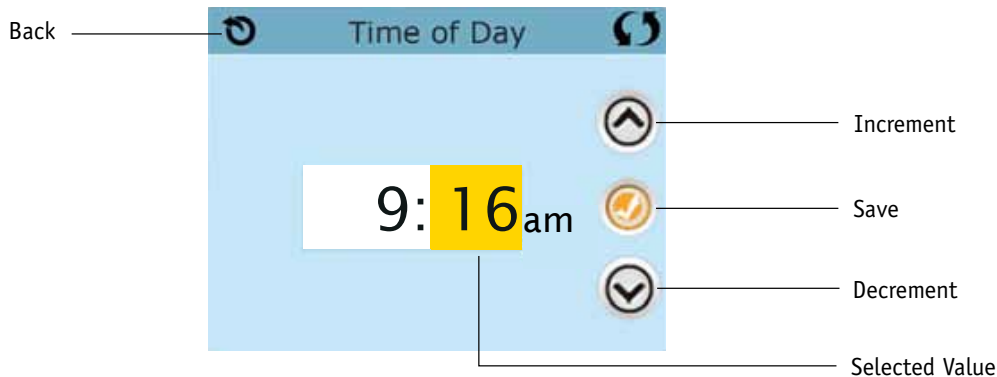

## Invert

Will appear on upper right on all screens.



Manufactured under one or more of these patents. U.S. Patents: 5332944, 5361215, 5550753, 5559720, 5,883,459, 6253227, 6282370, 6590188, 6976052, 6965815, 7030343, 7,417,834 b2, Canadian Patent: 2342614, Australian patent: 2373248 other patents both foreign and domestic applied for and pending.

## Common Buttons – Continued

### Exiting Screens

The Back button is on every screen except the Main Screen, the Priming Mode Screen and a Message Display Screen.

When you see only this button, or this button plus an Inactive Save Button, it means Back or Exit. It appears on editing screens before you have changed any value, as well as on all other screens.

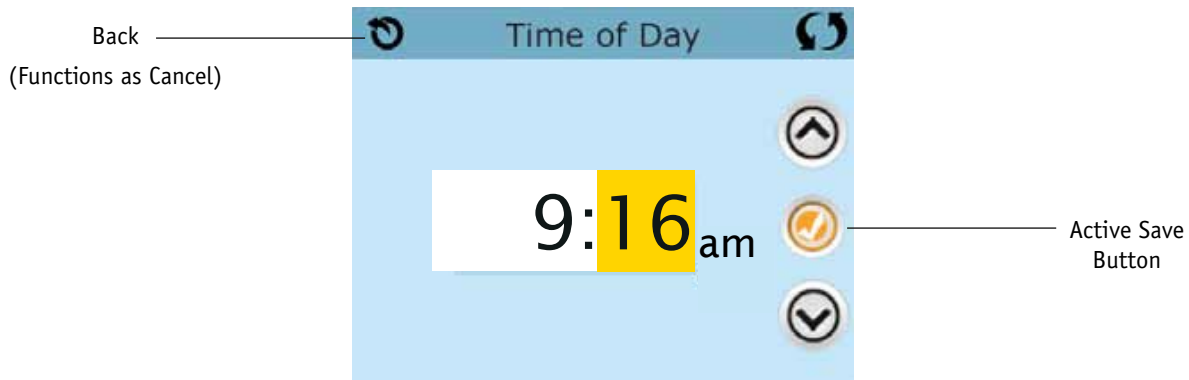
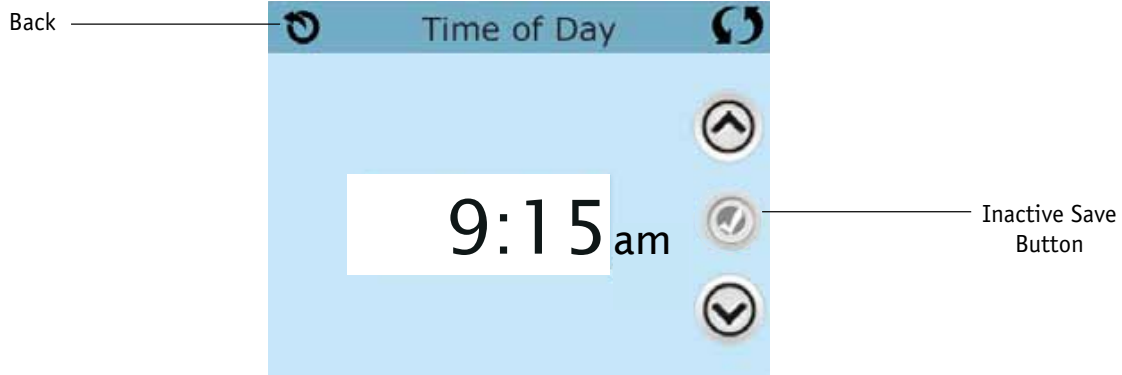

When you see both the Back button and an Active Save button, the Save button will Save, while the Back button will Cancel. If the screen times out due to no activity it will act like Cancel.

Manufactured under one or more of these patents. U.S. Patents: 5332944, 5361215, 5550753, 5559720, 5,883,459, 6253227, 6282370, 6590188, 6976052, 6965815, 7030343, 7,417,834 b2, Canadian Patent: 2342614, Australian patent: 2373248 other patents both foreign and domestic applied for and pending.

42281\_A

8

11-19-15

# Common Buttons – Continued

## Page Right/Left

If there is a right arrow at the bottom of the screen, it takes you to the next page.

If there is a left arrow at the bottom of the screen, it takes you to the previous page.



## Page Up/Down

If an Up or Down button is shown and pressed when on a page with a text list, the list can be scrolled a page at a time.

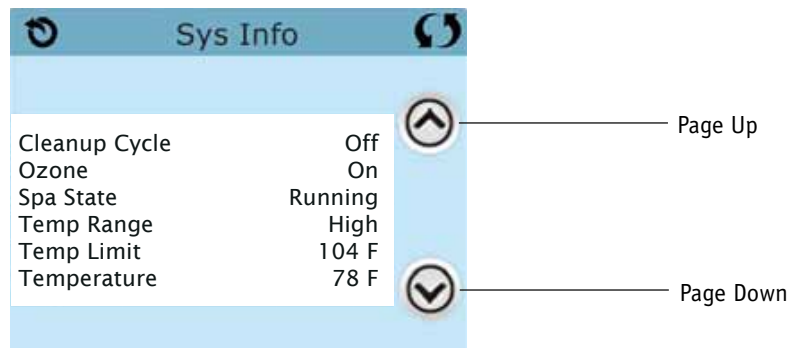

Manufactured under one or more of these patents. U.S. Patents: 5332944, 5361215, 5550753, 5559720, 5,883,459, 6253227, 6282370, 6590188, 6976052, 6965815, 7030343, 7,417,834 b2, Canadian Patent: 2342614, Australian patent: 2373248 other patents both foreign and domestic applied for and pending.

# The Settings Screen

## Programming, Etc.

The Settings Screen is where all programming and other spa behaviors are controlled.

Each icon on the Settings screen takes you to a different screen, where one or more setting may be viewed and/or edited.



The Heat Icon  takes you to a screen where you control the Heat Mode and the Temperature Range.

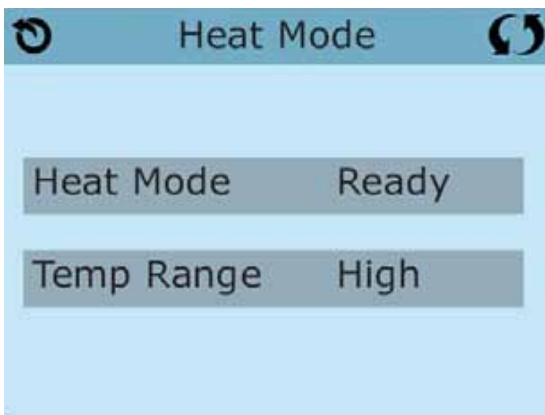

## Dual Temperature Ranges (High vs. Low)

This system incorporates two temperature range settings with independent set temperatures. The specific range can be selected on the Settings screen and is visible on the Main Screen in the upper left corner of the display.

These ranges can be used for various reasons, with a common use being a "ready to use" setting vs. a "vacation" setting. Each range maintains its own set temperature as programmed by the user. This way, when a range is chosen, the spa will heat to the set temperature associated with that range.

*High Range can be set between 80°F and 104°F.*

*Low Range can be set between 50°F and 99°F.*

*More specific Temp Ranges may be determined by the Manufacturer.*

*Freeze Protection is active in either range.*

Manufactured under one or more of these patents. U.S. Patents: 5332944, 5361215, 5550753, 5559720, 5,883,459, 6253227, 6282370, 6590188, 6976052, 6965815, 7030343, 7,417,834 b2, Canadian Patent: 2342614, Australian patent: 2373248 other patents both foreign and domestic applied for and pending.

42281\_A

10

11-19-15

# The Settings Screen – Continued

---

## Heat Mode – Ready vs. Rest

In order for the spa to heat, a pump needs to circulate water through the heater. The pump that performs this function is known as the “heater pump.”

The heater pump can be either a 2-speed pump (Pump 1) or a circulation pump.

If the heater pump is a 2-Speed Pump 1, Ready Mode will circulate water every 1/2 hour, using Pump 1 Low, in order to maintain a constant water temperature, heat as needed, and refresh the temperature display. This is known as “polling.”

Rest Mode will only allow heating during programmed filter cycles. Since polling does not occur, the temperature display may not show a current temperature until the heater pump has been running for a minute or two.

When the heater pump has come on automatically (for example for heating) you can switch between low speed and high speed but you cannot turn the heater pump off.

### **Circulation Mode (See Page 13, under Pumps, for other circulation modes)**

If the spa is configured for 24HR circulation, the heater pump generally runs continuously. Since the heater pump is always running, the spa will maintain set temperature and heat as needed in Ready Mode, without polling.

In Rest Mode, the spa will only heat to set temperature during programmed filter times, even though the water is being filtered constantly when in 24HR circulation mode.

## Ready-in-Rest Mode

Ready in Rest Mode appears in the display if the spa is in Rest Mode and the Jets 1 Button is pressed. When the heater pump has come on automatically (for example for heating) you can switch between low speed and high speed but you cannot turn the heater pump off. After 1 hour, the System will revert to Rest Mode. This mode can also be reset by selecting the Heat Mode line on the Screen shown here.

# Fill it up!

## Preparation and Filling

Fill the spa to its correct operating level. Be sure to open all valves and jets in the plumbing system before filling to allow as much air as possible to escape from the plumbing and the control system during the filling process.

After turning the power on at the main power panel, the top-side panel will display a splash screen or startup screen.

## Priming Mode – M019\*

After the initial start-up sequence, the control will enter Priming Mode and display a Priming Mode screen. Only pump icons appear on the priming mode screen. During the priming mode, the heater is disabled to allow the priming process to be completed without the possibility of energizing the heater under low-flow or no-flow conditions. Nothing comes on automatically, but the pump(s) can be energized by selecting the “Jet” buttons. If the spa has a Circ Pump, it can be turned on and off by pressing the “Circ” button during Priming Mode.

## Priming the Pumps

As soon as the Priming Mode screen appears on the panel, select the “Jets 1” button once to start Pump 1 in low-speed and then again to switch to high-speed. Also, select the other pumps, to turn them on. The pumps should be running in high-speed to facilitate priming. If the pumps have not primed after 2 minutes, and water is not flowing from the jets in the spa, do not allow the pumps to continue to run. Turn off the pumps and repeat the process. Note: Turning the power off and back on again will initiate a new pump priming session. Sometimes momentarily turning the pump off and on will help it to prime. Do not do this more than 5 times. If the pump(s) will not prime, shut off the power to the spa and call for service.

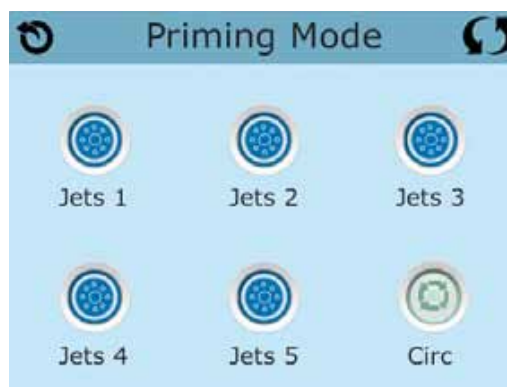

Important: A pump should not be allowed to run without priming for more than 2 minutes. Under NO circumstances should a pump be allowed to run without priming beyond the end of the 4-5 minute priming mode. Doing so may cause damage to the pump and cause the system to energize the heater and go into an overheat condition.

## Exiting Priming Mode

The system will automatically enter the normal heating and filtering at the end of the priming mode, which lasts 4-5 minutes.

You can manually exit Priming Mode by pressing the “Back” button on the Priming Mode Screen. Note that if you do not manually exit the priming mode as described above, the priming mode will be automatically terminated after 4-5 minutes. Be sure that the pump(s) have been primed by this time.

Once the system has exited Priming Mode, the top-side panel will display the Main Screen, but the display will not show the water temperature yet, as shown below. This is because the system requires approximately 1 minute of water flowing through the heater to determine the water temperature and display it.

— — — — °F      — — — — °C

\*M0XX is a Message Code. See Fault Log on Page 20.

Manufactured under one or more of these patents. U.S. Patents: 5332944, 5361215, 5550753, 5559720, 5,883,459, 6253227, 6282370, 6590188, 6976052, 6965815, 7030343, 7,417,834 b2, Canadian Patent: 2342614, Australian patent: 2373248 other patents both foreign and domestic applied for and pending.

42281\_A

12

11-19-15



# Spa Behavior

## Pumps

On the Spa Screen, select a “Jets” button once to turn the pump on or off, and to shift between low- and high-speeds if equipped. If left running, the pump will turn off after a time-out period.

### Non-Circ Systems

The low-speed of pump 1 runs when the blower or any other pump is on. If the spa is in Ready Mode (See page 11), Pump 1 low may also activate for at least 1 minute every 30 minutes to detect the spa temperature (polling) and then to heat to the set temperature if needed. When the low-speed turns on automatically, it cannot be deactivated from the panel, however the high speed may be started.

### Circulation Pump Modes

If the system is equipped with a circ pump, it will be configured to work in one of three different ways:

- 1, The circ pump operates continuously (24 hours) with the exception of turning off for 30 minutes at a time when the water temperature reaches 3°F (1.5°C) above the set temperature (most likely to happen in very hot climates).
- 2, The circ pump stays on continuously, regardless of water temperature.
- 3, A programmable circ pump will come on when the system is checking temperature (polling), during filter cycles, during freeze conditions, or when another pump is on.

The specific Circulation Mode that is used has been determined by the Manufacturer and cannot be changed in the field.

Other device options may be available, like Blower, Light, Mister, etc.

## Filtration and Ozone

On non-circ systems, Pump 1 low and the ozone generator will run during filtration. On circ systems, the ozone will generally run with the circ pump, but can be limited to filtration cycles. (On some circs systems, Pump 1 low will run along with the circ Pump during filtration.)

The system is factory-programmed with one filter cycle that will run in the evening (assuming the time-of-day is properly set) when energy rates are often lower. The filter time and duration are programmable. (See page 16)

A second filter cycle can be enabled as needed.

At the start of each filter cycle, the water devices like blower, mister device (if these exist) and other pumps will run briefly to purge the plumbing to maintain good water quality.

## Freeze Protection

If the temperature sensors within the heater detect a low enough temperature, then the water devices automatically activate to provide freeze protection. The water devices will run either continuously or periodically depending on conditions.

In colder climates, an optional freeze sensor may be added to protect against freeze conditions that may not be sensed by the standard sensors. Auxiliary freeze sensor protection acts similarly except with the temperature thresholds determined by the switch. See your dealer for details.

## Clean-up Cycle (optional)

When a pump or blower is turned on by a button press, a clean-up cycle begins 30 minutes after the pump or blower is turned off or times out. The pump and the ozone generator will run for 30 minutes or more, depending on the system. On some systems, you can change this setting. (See the Cleanup Cycle section on page 22)

Manufactured under one or more of these patents. U.S. Patents: 5332944, 5361215, 5550753, 5559720, 5,883,459, 6253227, 6282370, 6590188, 6976052, 6965815, 7030343, 7,417,834 b2, Canadian Patent: 2342614, Australian patent: 2373248 other patents both foreign and domestic applied for and pending.

42281\_A

13

11-19-15

## Time-of-Day

### Be sure to set the Time-of-Day

Setting the time-of-day is important for determining filtration times and other background features.

The Heat Icon  on the Settings Screen takes you to a screen where you control the Time-of-Day.

On the Time-of-Day screen, simply select the Hours and Minutes. Use the Up and Down Buttons to make changes, then Save.

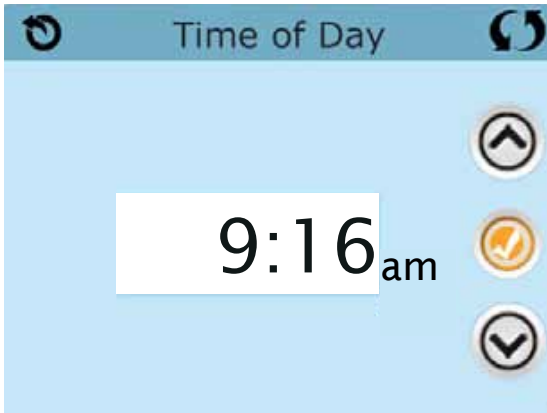

If no time-of-day is set in the memory an Information Screen will appear. If you exit it and Information Icon will appear at the bottom of the Main Screen, until the time-of-day has been set.



### Note:

This only applies to some systems:

If power is interrupted to the system, Time-of-Day will be maintained for several days.

Manufactured under one or more of these patents. U.S. Patents: 5332944, 5361215, 5550753, 5559720, 5,883,459, 6253227, 6282370, 6590188, 6976052, 6965815, 7030343, 7,417,834 b2, Canadian Patent: 2342614, Australian patent: 2373248 other patents both foreign and domestic applied for and pending.

42281\_A

14

11-19-15

# Adjusting Filtration

## Main Filtration

Using the same adjustment as Setting the Time, Filter Cycles are set using a start time and a duration. Each setting can be adjusted in 15-minute increments. The panel calculates the end time and displays it automatically.

The Filter Icon  on the Settings Screen takes you to a screen where you control the Filter Cycles.

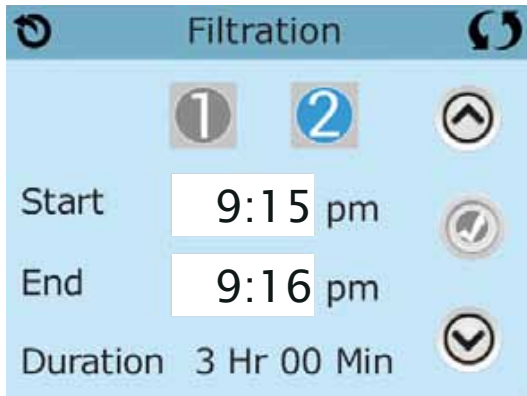

## Filter Cycle 2 - Optional Filtration

Filter Cycle 2 is OFF by default.

Viewing Filter 1 while Filter 2 is OFF:

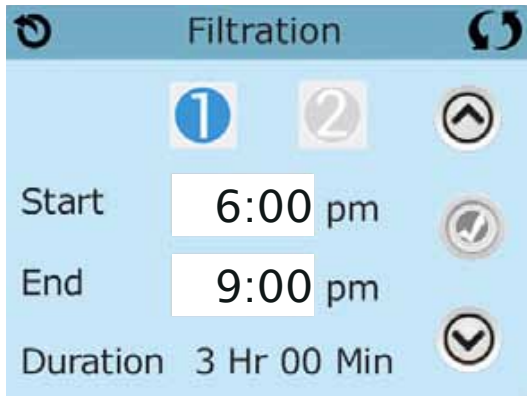

Viewing Filter 1 while Filter 2 is ON:

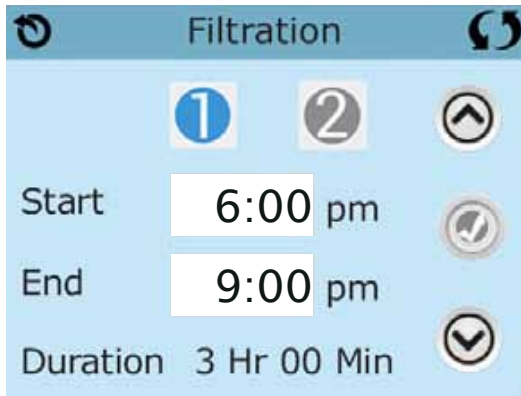

Press "1" to view Filter 1. Press "2" once to view Filter 2. Press "2" again to turn Filter 2 ON or OFF.

When Filter Cycle 2 is ON, it can be adjusted in the same manner as Filter Cycle 1.

It is possible to overlap Filter Cycle 1 and Filter Cycle 2, which will shorten overall filtration by the overlap amount.

Manufactured under one or more of these patents. U.S. Patents: 5332944, 5361215, 5550753, 5559720, 5,883,459, 6253227, 6282370, 6590188, 6976052, 6965815, 7030343, 7,417,834 b2, Canadian Patent: 2342614, Australian patent: 2373248 other patents both foreign and domestic applied for and pending.

# Adjusting Filtration – Continued

---

## Circulation Pump Modes

Some spas may be manufactured with Circ Pump settings that allow programming filtration cycle duration. Some circ Modes are pre-programmed to operate 24 hours a day and are not programmable. Refer to the spa manufacturer's documentation for any Circ Mode details.

## Purge Cycles

In order to maintain sanitary conditions, as well as protect against freezing, secondary water devices will purge water from their respective plumbing by running briefly at the beginning of each filter cycle. (Some systems will run a certain number of purge cycles per day, independent of the number of filter cycles per day. In this case, the purge cycles may not coincide with the start of the filter cycle.)

If the Filter Cycle 1 duration is set for 24 hours, enabling Filter Cycle 2 will initiate a purge when Filter Cycle 2 is programmed to begin.

## The Meaning of Filter Cycles

1. The heating pump always runs during the filter cycle\*
2. In Rest Mode, heating only occurs during the filter cycle
3. Purges happen at the start of each filter cycle

\*For example, if your spa is set up for 24/hour circulation except for shutting off when the water temperature is 3°F/1.3°C above the set temperature, that shutoff does not occur during filter cycles.

## Additional Settings

### Light Cycle Option

If Light Cycle does not appear on the Settings Screen, the Light Timer feature is not enabled by the manufacturer.

The Light Cycle Icon  on the Settings Screen takes you to a screen where you control the Light Cycle.

When available, the Light Timer is ("Disabled") by default. Press "Disabled" to change it to "Enabled" (ON).

The settings can be edited the same way that Filter Cycles are edited (see page 15).

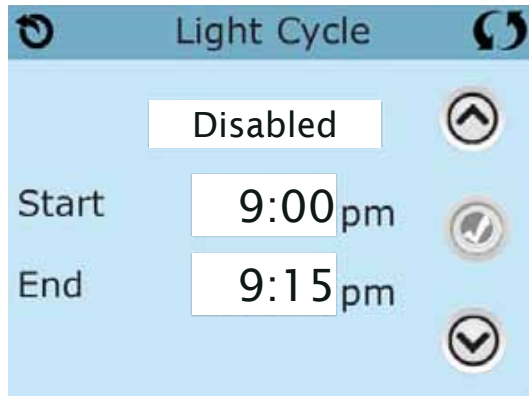

## Auxiliary Panel(s)

### Specific Buttons for Specific Devices

If the spa has an Auxiliary Panel(s) installed, pressing buttons on that panel will activate the device indicated for that button.

These dedicated buttons will operate just like the Spa Screen buttons (see page 6) and the equipment will behave in the same manner with each button press.

Manufactured under one or more of these patents. U.S. Patents: 5332944, 5361215, 5550753, 5559720, 5,883,459, 6253227, 6282370, 6590188, 6976052, 6965815, 7030343, 7,417,834 b2, Canadian Patent: 2342614, Australian patent: 2373248 other patents both foreign and domestic applied for and pending.

42281\_A

17

11-19-15

## Restricting Operation



The control can be restricted to prevent unwanted use or temperature adjustments.

Locking the Panel prevents the controller from being used, but all automatic functions are still active.

Locking the Settings allows Jets and other features to be used, but the Set Temperature and other programmed settings cannot be adjusted.

Settings Lock allows access to a reduced selection of menu items. These include Filter Cycles, Invert, Information and Fault Log. They can be seen, but not changed or edited.

Panel Locked and Settings Unlocked



## Locking and Unlocking



Press here for 5 seconds  
to lock or unlock.

The same steps are used to Lock and Unlock.

To lock either Settings or Panel first select Settings (if it says "Unlocked") or Panel (if it says "Unlocked"), then press the word "Lock" for at least 5 seconds.

To unlock either Settings or Panel first select Settings (if it says "Locked") or Panel (if it says "Locked"), then press the word "Lock" for at least 5 seconds.

Manufactured under one or more of these patents. U.S. Patents: 5332944, 5361215, 5550753, 5559720, 5,883,459, 6253227, 6282370, 6590188, 6976052, 6965815, 7030343, 7,417,834 b2, Canadian Patent: 2342614, Australian patent: 2373248 other patents both foreign and domestic applied for and pending.

42281\_A

18

11-19-15

# Additional Settings – Continued

## Hold - M037\*

Hold Mode is used to disable the pumps during service functions like cleaning or replacing the filter. Hold Mode will last for 1 hour unless the mode is exited manually. If spa service will require more than an hour, it may be best to simply shut down power to the spa.

The Hold Icon  on the Settings Screen places the spa in Hold Mode and displays the System Hold screen. Touch Back to exit Hold Mode.

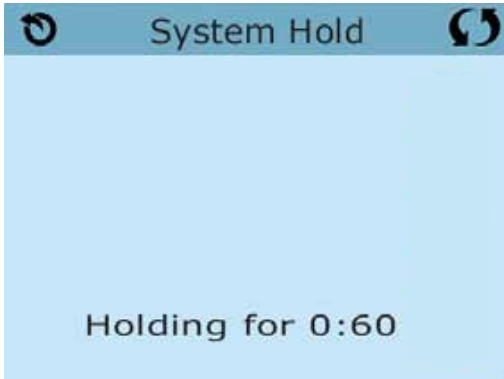

## Drain Mode

Some spas have a special feature that allows Pump 1 to be employed when draining the water. When available, this feature is a component of Hold Mode.



Touch this Icon to turn the Drain Pump ON or OFF.

\*M0XX is a Message Code. Codes like this will be seen in the Fault Log

Manufactured under one or more of these patents. U.S. Patents: 5332944, 5361215, 5550753, 5559720, 5,883,459, 6253227, 6282370, 6590188, 6976052, 6965815, 7030343, 7,417,834 b2, Canadian Patent: 2342614, Australian patent: 2373248 other patents both foreign and domestic applied for and pending.

# The Utilities Screen

## Utilities

The Utilities Icon  on the Settings Screen takes you to the Utilities Screen.

The Utilities Screen contains the following:



## Panel

Touching the Panel Icon  on the Utilities Screen takes you to the Panel Screen, where you can set how long it takes the panel to go to sleep after the last activity. The Sleep Timer can be set from 1 minute to 60 minutes. The default is 30 minutes.

## Demo Mode

Demo Mode is not always enabled, so it may not appear. This is designed to operate several devices in a sequence in order to demonstrate the various features of a particular hot tub.

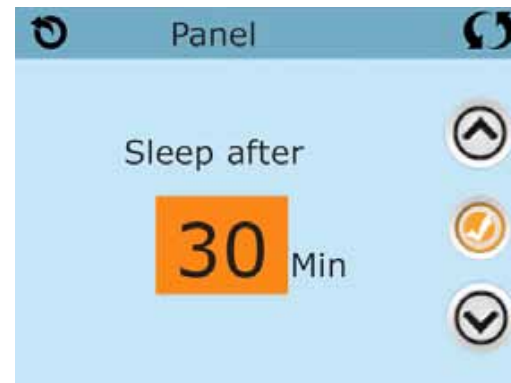

## Fault Log

The Fault Log is a record of the last 24 faults that can be reviewed by a service tech.

Use the Up and Down buttons to view each of the Faults.

When Priming Mode shows in the Fault Log, it is not a fault. Rather, it is used to keep track of spa restarts.

## GFCI Test

### (Feature not available on CE rated systems.)

Your systems may have GFCI configured in one of three ways:

1. GFCI test is not enabled
2. Manual GFCI test is enabled but automatic GFCI test is not enabled
3. Both manual and automatic GFCI tests are enabled. The automatic test will happen within 7 days of the spa being installed and if successful will not repeat. (If the automatic test fails it will repeat after the spa is restarted.)

GFCI Test will not appear on the screen if it is not enabled. This screen allows the GFCI to be tested manually from the panel and can be used to reset the automatic test feature. (See Page 24)



# Additional Settings – Continued

## Units Screen

The Units Icon  on the Settings Screen takes you to the Units Screen.

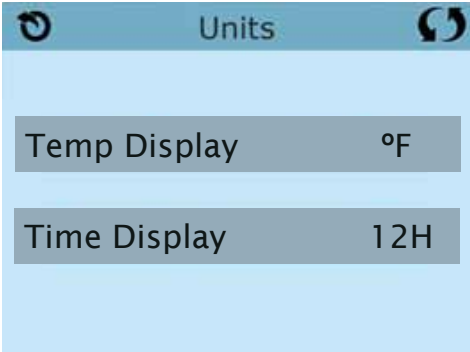

Press "Temp Display" to change the temperature between Fahrenheit and Celsius.  
Press "Time Display" to change the clock between 12 hr and 24 hr display.

## Reminders

The Reminder Icon  on the Settings Screen takes you to the Reminders screen.

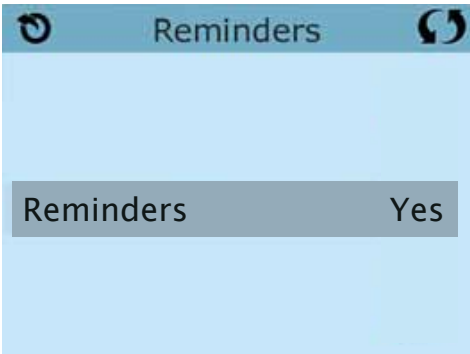

Press "Reminders" to turn the reminder messages (like "Clean Filter") ON (Yes) or OFF (No).

Manufactured under one or more of these patents. U.S. Patents: 5332944, 5361215, 5550753, 5559720, 5,883,459, 6253227, 6282370, 6590188, 6976052, 6965815, 7030343, 7,417,834 b2, Canadian Patent: 2342614, Australian patent: 2373248 other patents both foreign and domestic applied for and pending.

## Additional Settings – Continued

### Cleanup Cycle

Cleanup Cycle Duration is not always enabled, so it may not appear. When it is available, set the length of time Pump 1 will run after each use. 0-4 hours are available. Settings it to 0.0 Hr keeps the Cleanup Cycles from running.

The Cleanup Icon  on the Settings Screen takes you to the Cleanup Cycle screen.



### Language

The Language Icon  on the Settings Screen takes you to the Language screen.

Change the language displayed on the panel.



# Information

## System Information

The System Information Screen displays various settings and identification of the particular system.

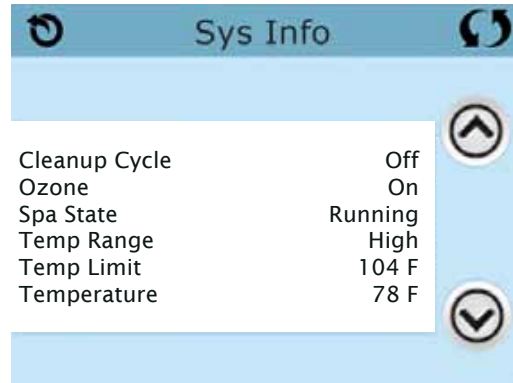

### System Model

Displays the Model Number of the System.

### Panel Version

Displays a number of the software in the topside control panel.

### Software ID (SSID)

Displays the software ID number for the System.

### Configuration Signature

Displays the checksum for the system configuration file.

### Current Setup

Displays the currently selected Configuration Setup Number.

### Dip Switch Settings

Displays a number that represents the DIP switch positions of S1 on the main circuit board.

### Heater Voltage (Feature not used on CE rated systems.)

Displays the operating voltage configured for the heater.

### Heater Wattage as Configured in Software (CE Systems Only.)

Displays a heater kilowatt rating as programmed into the control system software (1-3 or 3-6).

### Heater Type

Displays a heater type ID number.

Manufactured under one or more of these patents. U.S. Patents: 5332944, 5361215, 5550753, 5559720, 5,883,459, 6253227, 6282370, 6590188, 6976052, 6965815, 7030343, 7,417,834 b2, Canadian Patent: 2342614, Australian patent: 2373248 other patents both foreign and domestic applied for and pending.

## Utilities – GFCI Test Feature

The Ground Fault Circuit Interrupter (GFCI) or Residual Current Detector (RCD) is an important safety device and is required equipment on a hot tub installation.

**(The GFCI Test Feature is not available on CE rated systems.)**

### Used for verifying a proper installation

Your spa may be equipped with a GFCI Protection feature. If your spa has this feature enabled by the manufacturer, the GFCI Trip Test must occur to allow proper spa function.

On some systems:

Within 1 to 7 days after startup, the spa will trip the GFCI to test it. (The number of days is factory programmed.) The GFCI must be reset once it has tripped. After passing the GFCI Trip Test, any subsequent GFCI trips will indicate a ground fault or other unsafe condition and the power to the spa must be shut off until a service person can correct the problem.



### Forcing the GFCI Trip Test (North America Only)

Touching the GFCI Test Icon  on the Utilities Screen takes you to the GFCI Test screen.

The installer can cause the GFCI Trip Test to occur sooner by pressing Test on the GFCI Test screen.

The GFCI should trip within several seconds and the spa should shut down. If it does not, shut down the power and manually verify that a GFCI breaker is installed and that the circuit and spa are wired correctly. Verify the function of the GFCI with its own test button. Restore power to the spa and repeat the GFCI Trip Test.

Once the GFCI is tripped by the test, reset the GFCI and the spa will operate normally from that point. You can verify a successful test by navigating to the above screen. "Passed" should appear after the Reset line is selected on the GFCI screen.

### Warning:

On those systems that automatically test the GFCI within 1 to 7 days after startup:

The end-user must be trained to expect this one-time test to occur.

The end-user must be trained how to properly reset the GFCI.

If freezing conditions exist, the GFCI or RCD should be reset immediately or spa damage could result.

### CE Product:

CE registered systems do not have an RCD Test Feature due to the nature of the electrical service.

Some UL registered systems do not have the GFCI Test Feature activated.

The end-user must be trained how to properly test and reset the RCD.

### Reset Button:

Only use the Reset Button prior to moving the spa to a new location.

Pressing the Reset the button forces a new Test to be performed at the new location.

Manufactured under one or more of these patents. U.S. Patents: 5332944, 5361215, 5550753, 5559720, 5,883,459, 6253227, 6282370, 6590188, 6976052, 6965815, 7030343, 7,417,834 b2, Canadian Patent: 2342614, Australian patent: 2373248 other patents both foreign and domestic applied for and pending.

42281\_A

24

11-19-15

# General Messages

Most messages and alerts will appear at the bottom of the normally used screens. Several alerts and messages may be displayed in a sequence.

--- °F    --- °C

## Water Temperature is Unknown

After the pump has been running for 1 minute, the temperature will be displayed.



## Possible freezing condition

A potential freeze condition has been detected, or the Aux Freeze Switch has closed. All water devices are activated. In some cases, pumps may turn on and off and the heater may operate during Freeze Protection. This is an operational message, not an error indication.

## The water is too hot – M029\*

The system has detected a spa water temp of 110°F (43.3°C) or more, and spa functions are disabled. System will auto reset when the spa water temp is below 108°F (42.2°C). Check for extended pump operation or high ambient temp.

## The water level is too low

This message can only appear on a system that uses a water level sensor. It appears whenever the water level get too low (or the water level sensor is disconnected), and automatically disappears when the water level is adequate. Pumps and the heater turn OFF when this message appears.

\*MOXX is a Message Code. Codes like this will be seen in the Fault Log

Manufactured under one or more of these patents. U.S. Patents: 5332944, 5361215, 5550753, 5559720, 5,883,459, 6253227, 6282370, 6590188, 6976052, 6965815, 7030343, 7,417,834 b2, Canadian Patent: 2342614, Australian patent: 2373248 other patents both foreign and domestic applied for and pending.

42281\_A

25

11-19-15

## Heater-Related Messages

### The water flow is low – M016\*\*

There may not be enough water flow through the heater to carry the heat away from the heating element. Heater start up will begin again after about 1 min. See “Flow Related Checks” below.

### The water flow has failed\* – M017\*\*

There is not enough water flow through the heater to carry the heat away from the heating element and the heater has been disabled. See “Flow Related Checks” below. After the problem has been resolved, reset the message\*.

### The heater may be dry\* – M028\*\*

Possible dry heater, or not enough water in the heater to start it. The spa is shut down for 15 min. Reset this message\* to reset the heater start-up. See “Flow Related Checks” below.

### The heater is dry\* – M027\*\*

There is not enough water in the heater to start it. The spa is shut down. After the problem has been resolved, you must reset the message\* to restart heater start up. See “Flow Related Checks” below.

### The heater is too hot\* – M030\*\*

One of the water temp sensors has detected 118°F (47.8°C) in the heater and the spa is shut down. You must reset the message\* when water is below 108°F (42.2°C). See “Flow Related Checks” below.



## Flow-Related Checks

Check for low water level, suction flow restrictions, closed valves, trapped air, too many closed jets and pump prime.

On some systems, even when spa is shut down by an error condition, some equipment may occasionally turn on to continue monitoring temperature or if freeze protection is needed.

\* **Some messages can be reset from the panel.** Messages that can be reset will appear with a Clear Icon at the bottom of the Message Screen. Press the Clear Icon text to reset the message.



\*\*M0XX is a Message Code. Codes like this will be seen in the Fault Log

Manufactured under one or more of these patents. U.S. Patents: 5332944, 5361215, 5550753, 5559720, 5,883,459, 6253227, 6282370, 6590188, 6976052, 6965815, 7030343, 7,417,834 b2, Canadian Patent: 2342614, Australian patent: 2373248 other patents both foreign and domestic applied for and pending.

42281\_A

26

11-19-15

# Sensor-Related Messages

## Sensors are out of sync – M015\*\*

The temperature sensors MAY be out of sync by 3°F. Call for Service if this message does not disappear within a few minutes.

## Sensors are out of sync -- Call for service\* – M026\*\*

The temperature sensors ARE out of sync. The fault above has been established for at least 1 hour. Call for Service.



## Sensor A Fault, Sensor B Fault – Sensor A: M031\*\*, Sensor B: M032\*\*

A temperature sensor or sensor circuit has failed. Call for Service.

# Miscellaneous Messages

## Communications error

The control panel is not receiving communication from the System. Call for Service.

## Test software installed

The Control System is operating with test software. Call for Service.

\* *Some messages can be reset from the panel.* Messages that can be reset will appear with a Clear Icon at the bottom of the Message Screen. Press the Clear Icon text to reset the message.



\*\*M0XX is a Message Code. Codes like this will be seen in the Fault Log

Manufactured under one or more of these patents. U.S. Patents: 5332944, 5361215, 5550753, 5559720, 5,883,459, 6253227, 6282370, 6590188, 6976052, 6965815, 7030343, 7,417,834 b2, Canadian Patent: 2342614, Australian patent: 2373248 other patents both foreign and domestic applied for and pending.

## System-Related Messages

### Program memory failure\* – M022\*\*

At Power-Up, the system has failed the Program Checksum Test. This indicates a problem with the firmware (operation program) and requires a service call.

### The settings have been reset (Persistent Memory Error)\* – M021\*\*

Contact your dealer or service organization if this message appears on more than one power-up.

### The clock has failed\* – M020\*\*

Contact your dealer or service organization.

### Configuration error (Spa will not Start Up)

Contact your dealer or service organization.

### The GFCI test failed (System Could Not Test the GFCI) – M036\*\*

(North America Only) May indicate an unsafe installation. Contact your dealer or service organization.

### A pump may be stuck on – M034\*\*

Water may be overheated. POWER DOWN THE SPA. DO NOT ENTER THE WATER. Contact your dealer or service organization.

### Hot fault – M035\*\*

A Pump Appears to have been Stuck ON when spa was last powered  
POWER DOWN THE SPA. DO NOT ENTER THE WATER. Contact your dealer or service organization.

\* *Some messages can be reset from the panel.* Messages that can be reset will appear with a Clear Icon at the bottom of the Message Screen. Press the Clear Icon text to reset the message.



\*\*M0XX is a Message Code. Codes like this will be seen in the Fault Log

Manufactured under one or more of these patents. U.S. Patents: 5332944, 5361215, 5550753, 5559720, 5,883,459, 6253227, 6282370, 6590188, 6976052, 6965815, 7030343, 7,417,834 b2, Canadian Patent: 2342614, Australian patent: 2373248 other patents both foreign and domestic applied for and pending.

42281\_A

28

11-19-15



# Reminder Messages

---

## General maintenance helps.

Reminder Messages can be suppressed by using the Reminders Screen. See Page 21.

Reminder Messages can be chosen individually by the Manufacturer. They may be disabled entirely, or there may be a limited number of reminders on a specific model. The frequency of each reminder (i.e. 7 days) can be specified by the Manufacturer.

---

## Check the pH

May appear on a regular schedule, i.e. every 7 days.

Check pH with a test kit and adjust pH with the appropriate chemicals.

---

## Check the sanitizer

May appear on a regular schedule, i.e. every 7 days.

Check sanitizer level and other water chemistry with a test kit and adjust with the appropriate chemicals.

---

## Clean the filter

May appear on a regular schedule, i.e. every 30 days.

Clean the filter media as instructed by the manufacturer. See Hold on page 19.

---

## Test the GFCI (or RCD)

May appear on a regular schedule, i.e. every 30 days.

The GFCI or RCD is an important safety device and must be tested on a regular basis to verify its reliability.

Every user should be trained to safely test the GFCI or RCD associated with the hot tub installation.

A GFCI or RCD will have a TEST and RESET button on it that allows a user to verify proper function.

---

## Change the water

May appear on a regular schedule, i.e. every 90 days.

Change the water in the spa on regular basis to maintain proper chemical balance and sanitary conditions.

---

Additional messages may appear on specific systems.

**Reminder messages can be reset from the panel.** Messages that can be reset will appear with a Clear Icon at the bottom of the Message Screen. Press the Clear Icon text to reset the message.

---



## Reminder Messages – Continued

---

### Clean the cover

May appear on a regular schedule, i.e. every 180 days.

Vinyl covers should be cleaned and conditioned for maximum life.

---

### Treat the wood

May appear on a regular schedule, i.e. every 180 days.

Wood skirting and furniture should be cleaned and conditioned per the manufacturers instructions for maximum life.

---

### Change the filter

May appear on a regular schedule, i.e. every 365 days.

Filters should be replaced occasionally to maintain proper spa function and sanitary conditions.

---

### Change the UV

May appear on a regular schedule.

Change the UV as instructed by the manufacturer.

---

### Check ozone

May appear on a regular schedule.

Check the ozone generator as instructed by the manufacturer.

---

### Service check-up

May appear on a regular schedule.

Do a service check-up as instructed by the manufacturer.

---

Additional messages may appear on specific systems.

**Reminder messages can be reset from the panel.** Messages that can be reset will appear with a Clear Icon at the bottom of the Message Screen. Press the Clear Icon text to reset the message.

---



# Warning! Qualified Technician Required for Service and Installation

## Basic Installation and Configuration Guidelines

Use minimum 6AWG copper conductors only.

Torque field connections between 21 and 23 in lbs.

Readily accessible disconnecting means to be provided at time of installation.

Permanently connected power supply.

Connect only to a circuit protected by a Class A Ground Fault Circuit Interrupter (GFCI) or Residual Current Device (RCD) mounted at least 5' (1.52M) from the inside walls of the spa/hot tub and in line of sight from the equipment compartment.

CSA enclosure: Type 2

Refer to Wiring Diagram inside the cover of the control enclosure.

Refer to Installation and Safety Instructions provided by the spa manufacturer.

**Warning:** People with infectious diseases should not use a spa or hot tub.

**Warning:** To avoid injury, exercise care when entering or exiting the spa or hot tub.

**Warning:** Do not use a spa or hot tub immediately following strenuous exercise.

**Warning:** Prolonged immersion in a spa or hot tub may be injurious to your health.

**Warning:** Maintain water chemistry in accordance with the Manufacturers instructions.

**Warning:** The equipment and controls shall be located not less than 1.5 meters horizontally from the spa or hot tub.

## Warning! GFCI or RCD Protection.

The Owner should test and reset the GFCI or RCD on a regular basis to verify its function.

## Warning! Shock Hazard! No User Serviceable Parts.

Do not attempt service of this control system. Contact your dealer or service organization for assistance. Follow all owner's manual power connection instructions. Installation must be performed by a licensed electrician and all grounding connections must be properly installed.

## CSA Compliance/Conformité

### Caution:

- Test the ground fault circuit interrupter before each use of the spa.
- Read the instruction manual.
- Adequate drainage must be provided if the equipment is to be installed in a pit.
- For use only within an enclosure rated CSA Enclosure 3.
- Connect only to a circuit protected by a Class A ground fault circuit interrupter or residual current device.
- To ensure continued protection against shock hazard, use only identical replacement parts when servicing.
- Install a suitably rated suction guard to match the maximum flow rate marked.

### Warning:

- Water temperature in excess of 38°C may be injurious to your health.
- Disconnect the electrical power before servicing.

### Attention:

- Toujours vérifier l'efficacité du disjoncteur différentiel avant d'utiliser différentiel avant d'utiliser le bain.
- Lire la notice technique.
- Lorsque l'appareillage est installé dans une fosse, on doit assurer un drainage adéquat.
- Employer uniquement à l'intérieur d'une clôture CSA Enclosure 3.
- Connecter uniquement à un circuit protégé par un disjoncteur différentiel de Class A.
- Afin d'assurer une protection permanente contre le danger de shock électrique, lors de l'entretien employer seulement des pièces de rechange identiques.
- Les prises d'aspiration doivent être équipées de grilles convenant au débit maximal indiqué.

### Avertissement:

- Des températures de l'eau supérieures à 38°C peuvent présenter un danger pour la santé.
- Déconnecter du circuit d'alimentation électrique avant l'entretien.

### Warning/Advertissement:

- Disconnect the electric power before servicing. Keep access door closed.
- Déconnecter du circuit d'alimentation électrique avant l'entretien. Garder la porte fermée.

# Index

12 hr and 24 hr display . . . . .	21	<b>L</b>	Language . . . . .	22	<b>S</b>	Set Temperature . . . . .	2, 5
<b>A</b>		Light . . . . .	2	Set Temperature Down . . . . .	2	Set Temperature Up . . . . .	2
Auxiliary Panel(s) . . . . .	17	Light Cycle . . . . .	17	Settings . . . . .	2, 10	Settings Screen . . . . .	10
<b>C</b>		Lights . . . . .	3	Spa Equipment Control . . . . .	2, 3	Spa Screen . . . . .	6
Celsius . . . . .	21	Lock Icon . . . . .	3	Spa Status . . . . .	2	System Information . . . . .	23
Circulation . . . . .	11, 13, 16	Lock Indicator Icon . . . . .	2	<b>T</b>		Temp Display . . . . .	21
Cleanup . . . . .	22	Locking the Panel . . . . .	18	Temperature Range . . . . .	2	Temperature Ranges . . . . .	10
Clean-up Cycle . . . . .	13	Locking the Settings . . . . .	18	Temperature Scale . . . . .	2	Time-of-Day . . . . .	2, 14
Cleanup Cycle . . . . .	2, 3	Low Range . . . . .	10	<b>U</b>		Unlocking . . . . .	18
Current Water Temperature . . . . .	2	Low Temperature Range . . . . .	3	Utilities . . . . .	20	<b>V</b>	
<b>E</b>		<b>M</b>		Values Increment/Decrement . . . . .	7	<b>W</b>	
Exiting Screens . . . . .	8	Main Screen . . . . .	2	<b>W</b>		Wi-Fi . . . . .	3
<b>F</b>		Messages . . . . .	4, 25, 26, 27, 28, 30	Wi-Fi Signal Indicator . . . . .	2		
Fahrenheit . . . . .	21	Message Waiting Indicator . . . . .	2, 3				
Fatal error . . . . .	3	Music . . . . .	2, 3				
Fault Log . . . . .	20	<b>N</b>					
Filter . . . . .	2	Navigation . . . . .	4				
Filter1 . . . . .	3	Non-Circ . . . . .	13				
Filter2 . . . . .	3	Normal Error . . . . .	3				
filter cycle . . . . .	13, 16	<b>O</b>					
Filter Cycle . . . . .	2	Ozone . . . . .	2, 3				
Flow-Related Checks . . . . .	26	<b>P</b>					
Freeze Protection . . . . .	10, 13, 25	Page Up/Down . . . . .	9				
<b>G</b>		Panel Version . . . . .	23				
GFCI . . . . .	31	polling . . . . .	13				
GFCI Test . . . . .	20, 24	Press-and-Hold . . . . .	5				
<b>H</b>		Priming Mode . . . . .	12				
Heat Indicator . . . . .	2	Programming . . . . .	10				
Heat Mode . . . . .	11	Pumps . . . . .	13				
High Range . . . . .	10	purge . . . . .	13, 16				
High Temperature Range . . . . .	2, 3	<b>R</b>					
Hold . . . . .	19	RCD . . . . .	24, 31				
<b>I</b>		Ready And Rest Mode . . . . .	3				
Information . . . . .	23	Ready-in-Rest Mode . . . . .	11				
Information Message . . . . .	3	Ready Mode . . . . .	2, 3, 11				
Invert . . . . .	2, 3	Reminder Message . . . . .	3				
<b>J</b>		Reminder Messages . . . . .	29				
Jet . . . . .	3	Rest Mode . . . . .	3, 11				

# TP600/TP400

## TP600 and TP400 Control Panels

### User Interface and Programming Reference – Standard Menus

System Model:	BP-Series Systems are BP5XX, BP6XX, BP1XXX, BP2XXX.	
Software Version:	7.0 and later	
Panel Model:	TP600 Series	TP400 Series
Software Version:	2.3 or later	2.4 or later



Manufactured under one or more of these patents. U.S. Patents: 5332944, 5361215, 5550753, 5559720, 5,883,459, 6253227, 6282370, 6590188, 6976052, 6965815, 7030343, 7,417,834 b2, Canadian Patent: 2342614, Australian patent: 2373248 other patents both foreign and domestic applied for and pending.

40940\_J

10-08-13

# Main Menu

## Navigation

Navigating the entire menu structure is done with 2 or 3 buttons on the control panel.



Some panels have separate **WARM** (Up) and **COOL** (Down) buttons, while others have a single **Temperature** button. In the navigation diagrams Temperature buttons are indicated by a single button icon.

Panels that have two Temperature buttons (Warm and Cool) can use both of them to simplify navigation and programming where a single Temperature icon is shown.

The **LIGHT** Button is also used to choose the various menus and navigate each section.

Typical use of the Temperature button(s) allows changing the Set Temperature while the numbers are flashing in the LCD.

Pressing the **LIGHT** button while the numbers are flashing will enter the menus.

The menu can be exited with certain button presses. Simply waiting for several seconds will return the panel operation to normal.

### Power-up Screens

Each time the System powers up, a series of numbers is displayed. After the startup sequence of numbers, the system will enter Priming Mode (See Page 3).

### Key

- Indicates Flashing or Changing Segment
- Indicates Alternating or Progressive Message - every 1/2 second
- ⏏ A temperature button, used for "Action"
- ☀ Light or dedicated "Choose" button, depending on control panel configuration
- Waiting time that keeps the last change to a menu item.
- \*\*\*\*\* Waiting time (depends on menu item) that reverts to original setting and ignores any change to that menu item.

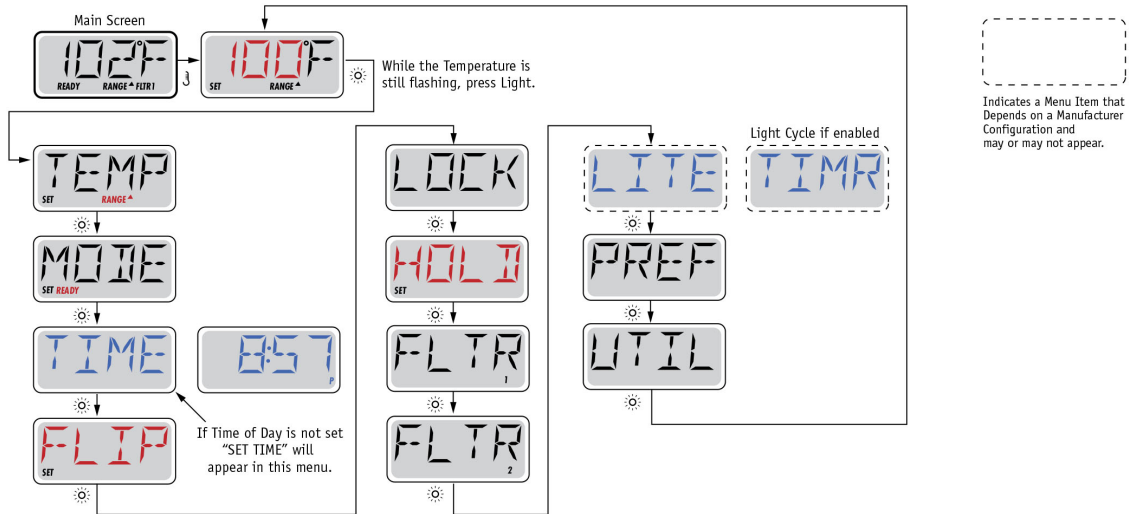

Waiting Several Seconds in the Main Menu will allow the display to revert to the Main Screen. Most changes are not saved unless Light ☀ is pressed. Refer to Key above.

Manufactured under one or more of these patents. U.S. Patents: 5332944, 5361215, 5550753, 5559720, 5,883,459, 6253227, 6282370, 6590188, 6976052, 6965815, 7030343, 7,417,834 b2, Canadian Patent: 2342614, Australian patent: 2373248 other patents both foreign and domestic applied for and pending.

# Fill it up!

## Preparation and Filling

Fill the spa to its correct operating level. Be sure to open all valves and jets in the plumbing system before filling to allow as much air as possible to escape from the plumbing and the control system during the filling process.

After turning the power on at the main power panel, the top-side panel display will go through specific sequences. These sequences are normal and display a variety of information regarding the configuration of the hot tub control.

## Priming Mode – M019\*

This mode will last for 4-5 minutes or you can manually exit the priming mode after the pump(s) have primed.



Regardless of whether the priming mode ends automatically or you manually exit the priming mode, the system will automatically return to normal heating and filtering at the end of the priming mode. During the priming mode, the heater is disabled to allow the priming process to be completed without the possibility of energizing the heater under low-flow or no-flow conditions. Nothing comes on automatically, but the pump(s) can be energized by pushing the “Jet” buttons. If the spa has a Circ Pump, it can be activated by pressing the “Light” button during Priming Mode.

## Priming the Pumps

As soon as the above display appears on the panel, push the “Jet” button once to start Pump 1 in low-speed and then again to switch to high-speed. Also, push the Pump 2 or “Aux” button, if you have a 2nd pump, to turn it on. The pumps will now be running in high-speed to facilitate priming. If the pumps have not primed after 2 minutes, and water is not flowing from the jets in the spa, do not allow the pumps to continue to run. Turn off the pumps and repeat the process. Note: Turning the power off and back on again will initiate a new pump priming session. Sometimes momentarily turning the pump off and on will help it to prime. Do not do this more than 5 times. If the pump(s) will not prime, shut off the power to the spa and call for service.

Important: A pump should not be allowed to run without priming for more than 2 minutes. Under NO circumstances should a pump be allowed to run without priming beyond the end of the 4-5 minute priming mode. Doing so may cause damage to the pump and cause the system to energize the heater and go into an overheat condition.

## Exiting Priming Mode

You can manually exit Priming Mode by pressing a “Temp” button (Up or Down). Note that if you do not manually exit the priming mode as described above, the priming mode will be automatically terminated after 4-5 minutes. Be sure that the pump(s) have been primed by this time.

Once the system has exited Priming Mode, the top-side panel will momentarily display the set temperature but the display will not show the temperature yet, as shown below. This is because the system requires approximately 1 minute of water

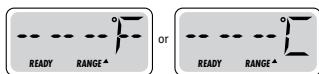

flowing through the heater to determine the water temperature and display it.

\*M019 is a Message Code. See Page 15.

Manufactured under one or more of these patents. U.S. Patents: 5332944, 5361215, 5550753, 5559720, 5,883,459, 6253227, 6282370, 6590188, 6976052, 6965815, 7030343, 7,417,834 b2, Canadian Patent: 2342614, Australian patent: 2373248 other patents both foreign and domestic applied for and pending.

# Spa Behavior

## Pumps

Press the “Jets 1” button once to turn pump 1 on or off, and to shift between low- and high-speeds if equipped. If left running, the pump will turn off after a time-out period. The pump 1 low-speed will time out after 30 minutes. The high-speed will time out after 15 minutes.

On non-circ systems, the low-speed of pump 1 runs when the blower or any other pump is on. If the spa is in Ready Mode (See page 6), Pump 1 low may also activate for at least 1 minute every 30 minutes to detect the spa temperature (polling) and then to heat to the set temperature if needed. When the low-speed turns on automatically, it cannot be deactivated from the panel, however the high speed may be started.

### Circulation Pump Modes

If the system is equipped with a circ pump, it will be configured to work in one of three different ways:

- 1, The circ pump operates continuously (24 hours) with the exception of turning off for 30 minutes at a time when the water temperature reaches 3°F (1.5°C) above the set temperature (most likely to happen in very hot climates).
- 2, The circ pump stays on continuously, regardless of water temperature.
- 3, A programmable circ pump will come on when the system is checking temperature (polling), during filter cycles, during freeze conditions, or when another pump is on.

The specific Circulation Mode that is used has been determined by the Manufacturer and cannot be changed in the field.

## Filtration and Ozone

On non-circ systems, Pump 1 low and the ozone generator will run during filtration. On circ systems, the ozone will run with the circ pump.

The system is factory-programmed with one filter cycle that will run in the evening (assuming the time-of-day is properly set) when energy rates are often lower. The filter time and duration are programmable. (See page 10)

A second filter cycle can be enabled as needed.

At the start of each filter cycle, the blower (if there is one) or Pump 2 (if there is one) will run briefly to purge its plumbing to maintain good water quality.

## Freeze Protection

If the temperature sensors within the heater detect a low enough temperature, then the pump(s) and the blower automatically activate to provide freeze protection. The pump(s) and blower will run either continuously or periodically depending on conditions.

In colder climates, an optional additional freeze sensor may be added to protect against freeze conditions that may not be sensed by the standard sensors. Auxiliary freeze sensor protection acts similarly except with the temperature thresholds determined by the switch. See your dealer for details.

## Clean-up Cycle (optional)

When a pump or blower is turned on by a button press, a clean-up cycle begins 30 minutes after the pump or blower is turned off or times out. The pump and the ozone generator will run for 30 minutes or more, depending on the system. On some systems, you can change this setting. (See the Preferences section on page 12)



# Temperature and Temp Range

## Adjusting the Set Temperature

When using a panel with Up and Down buttons (Temperature buttons), pressing Up or Down will cause the temperature to flash. Pressing a temperature button again will adjust the temperature in the direction indicated on the button. When the LCD stops flashing, the spa will heat to the new set temperature when required.

If the panel has a single temperature button, pressing the button will cause the temperature to flash. Pressing the button again will cause the temperature to change in one direction (e.g. UP). After allowing the display to stop flashing, pressing the Temperature Button will cause the temperature to flash and the next press will change the temperature in the opposite direction (e.g. DOWN).

## Press-and-Hold

If a Temperature button is pressed and held when the temperature is flashing, the temperature will continue to change until the button is released. If only one temperature button is available and the limit of the Temperature Range is reached when the button is being held, the progression will reverse direction.

## Dual Temperature Ranges

This system incorporates two temperature range settings with independent set temperatures. The High Range designated in the display by an "up" arrow, and the Low Range designated in the display by a "down" arrow.

These ranges can be used for various reasons, with a common use being a "ready to use" setting vs. a "vacation" setting. The Ranges are chosen using the menu structure below. Each range maintains its own set temperature as programmed by the user. This way, when a range is chosen, the spa will heat to the set temperature associated with that range.

For example:

*High Range might be set between 80°F and 104°F.*

*Low Range might be set between 50°F and 99°F.*

*More specific Temp Ranges may be determined by the Manufacturer.*

*Freeze Protection is active in either range.*

*See Ready and Rest on Page 6 for additional heating control information.*

### Key

- █ Indicates Flashing or Changing Segment
- █ Indicates Alternating or Progressive Message - every 1/2 second
- ⏏ A temperature button, used for "Action"
- ☀ Light or dedicated "Choose" button, depending on control panel configuration
- Waiting time that keeps the last change to a menu item.
- \*\*\*\* Waiting time (depends on menu item) that reverts to original setting and ignores any change to that menu item.

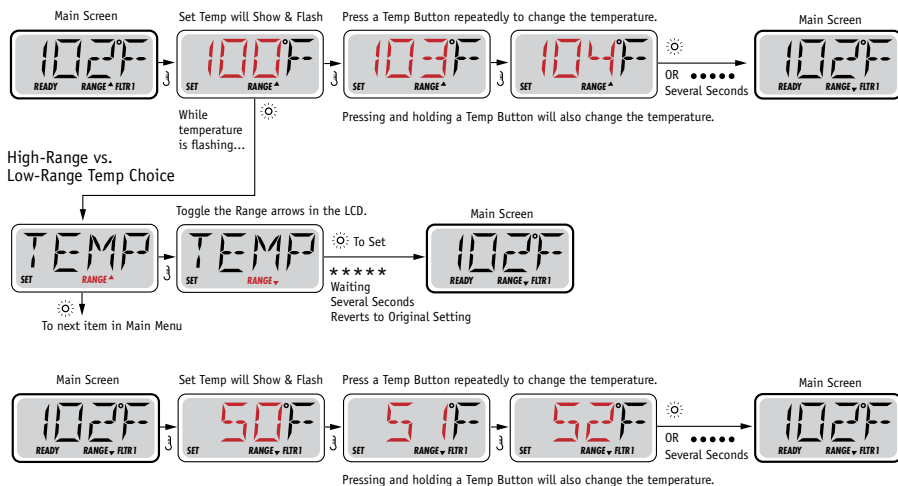

Manufactured under one or more of these patents. U.S. Patents: 5332944, 5361215, 5550753, 5559720, 5,883,459, 6253227, 6282370, 6590188, 6976052, 6965815, 7030343, 7,417,834 b2, Canadian Patent: 2342614, Australian patent: 2373248 other patents both foreign and domestic applied for and pending.

## Mode – Ready and Rest

In order for the spa to heat, a pump needs to circulate water through the heater. The pump that performs this function is known as the “heater pump.”

The heater pump can be either a 2-Speed Pump 1 or a circulation pump.

If the heater pump is a 2-Speed Pump 1, READY Mode will circulate water every 1/2 hour, using Pump 1 Low, in order to maintain a constant water temperature, heat as needed, and refresh the temperature display. This is known as “polling.”

REST Mode will only allow heating during programmed filter cycles. Since polling does not occur, the temperature display may not show a current temperature until the heater pump has been running for a minute or two.

### Circulation Mode (See Page 4, under Pumps, for other circulation modes)

If the spa is configured for 24HR circulation, the heater pump generally runs continuously. Since the heater pump is always running, the spa will maintain set temperature and heat as needed in Ready Mode, without polling.

In Rest Mode, the spa will only heat to set temperature during programmed filter times, even though the water is being filtered constantly when in Circulation Mode.

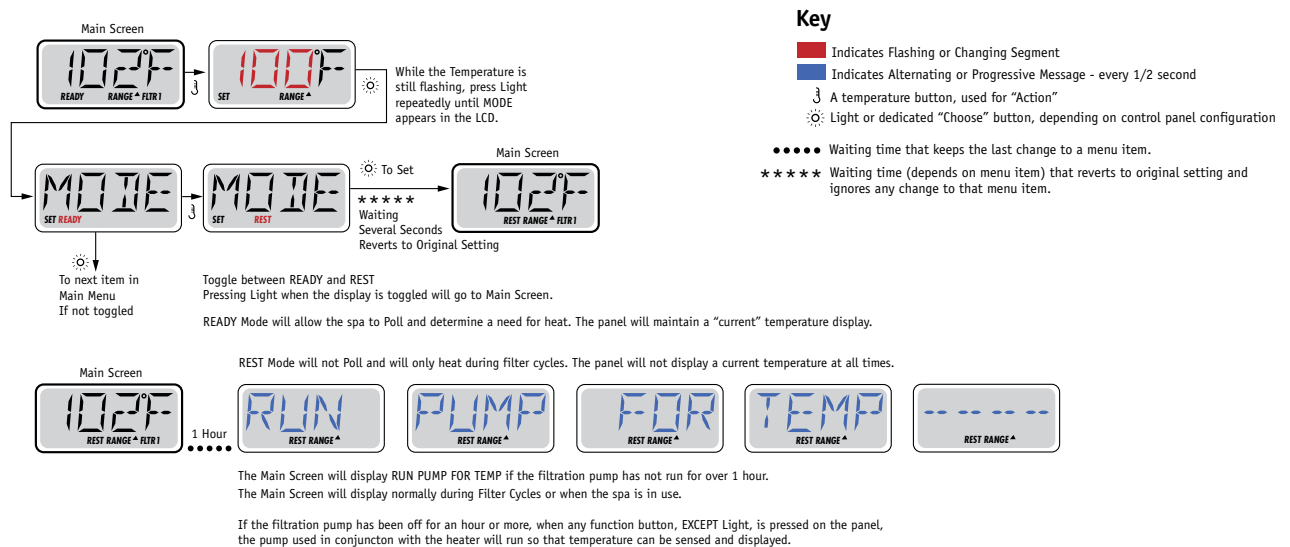

### Ready-in-Rest Mode

READY/REST appears in the display if the spa is in Rest Mode and Jet 1 is pressed. It is assumed that the spa is being used and will heat to set temperature. While Pump 1 High can be turned on and off, Pump 1 Low will run until set temperature is reached, or 1 hour has passed. After 1 hour, the System will revert to Rest Mode. This mode can also be reset by entering the Mode Menu and changing the Mode.

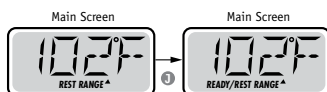

Manufactured under one or more of these patents. U.S. Patents: 5332944, 5361215, 5550753, 5559720, 5,883,459, 6253227, 6282370, 6590188, 6976052, 6965815, 7030343, 7,417,834 b2, Canadian Patent: 2342614, Australian patent: 2373248 other patents both foreign and domestic applied for and pending.

40940\_J

6

10-08-13

# Show and Set Time-of-Day

## Be sure to set the Time-of-Day

Setting the time-of-day can be important for determining filtration times and other background features.

When in the TIME menu, SET TIME will flash on the display if no time-of-day is set in the memory.

24-hour time display can be set under the PREF menu. (See Page 10)

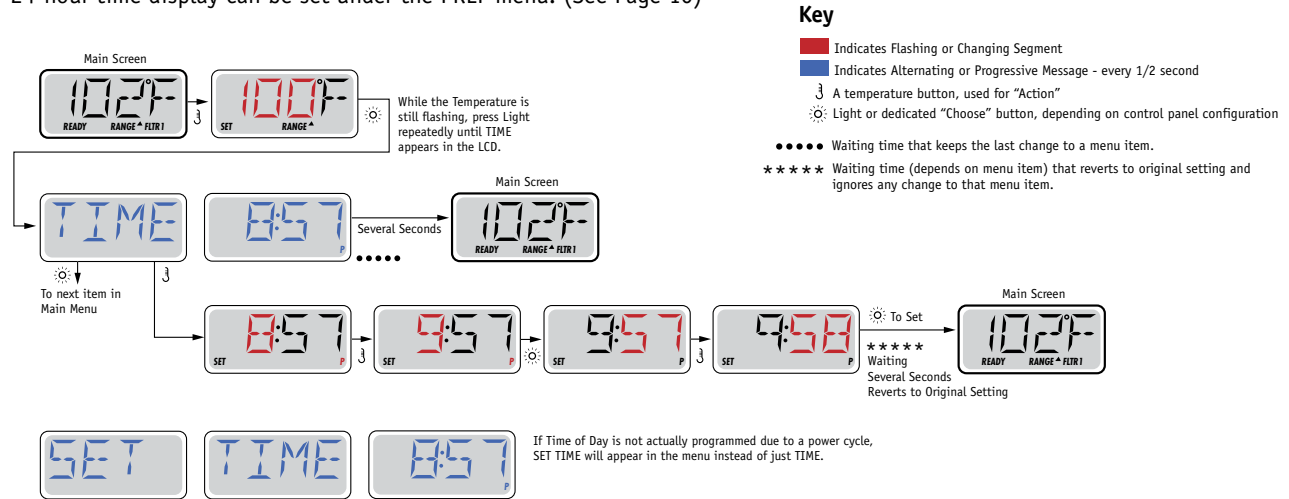

### Note:

If power is interrupted to the system, Time-of-Day is not stored. The system will still operate and all other user settings will be stored. If filter cycles are required to run at a particular time of day, resetting the clock will return the filter times to the actual programmed periods.

When the system starts up, it defaults to 12:00 Noon, so another way to get filter times back to normal is to start up the spa at noon on any given day. SET TIME will still flash in the TIME Menu until the time is actually set, but since the spa started at noon, the filter cycles will run as programmed.

# Flip (Invert Display)

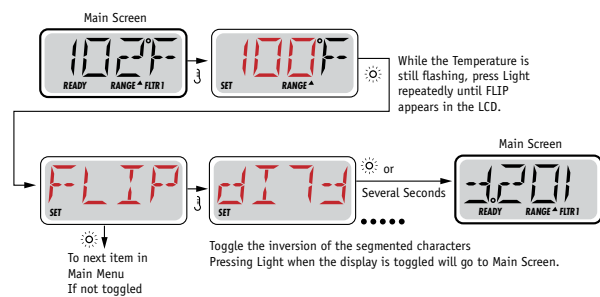

### Note:

Some panels may have a dedicated FLIP button, which allows the user to flip the display with a single button-press.

Manufactured under one or more of these patents. U.S. Patents: 5332944, 5361215, 5550753, 5559720, 5,883,459, 6253227, 6282370, 6590188, 6976052, 6965815, 7030343, 7,417,834 b2, Canadian Patent: 2342614, Australian patent: 2373248 other patents both foreign and domestic applied for and pending.

# Restricting Operation

The control can be restricted to prevent unwanted use or temperature adjustments.

Locking the panel prevents the controller from being used, but all automatic functions are still active.

Locking the Temperature allows Jets and other features to be used, but the Set Temperature and other programmed settings cannot be adjusted.

Temperature Lock allows access to a reduced selection of menu items.

These include Set Temperature, FLIP, LOCK, UTIL, INFO and FALT LOG.

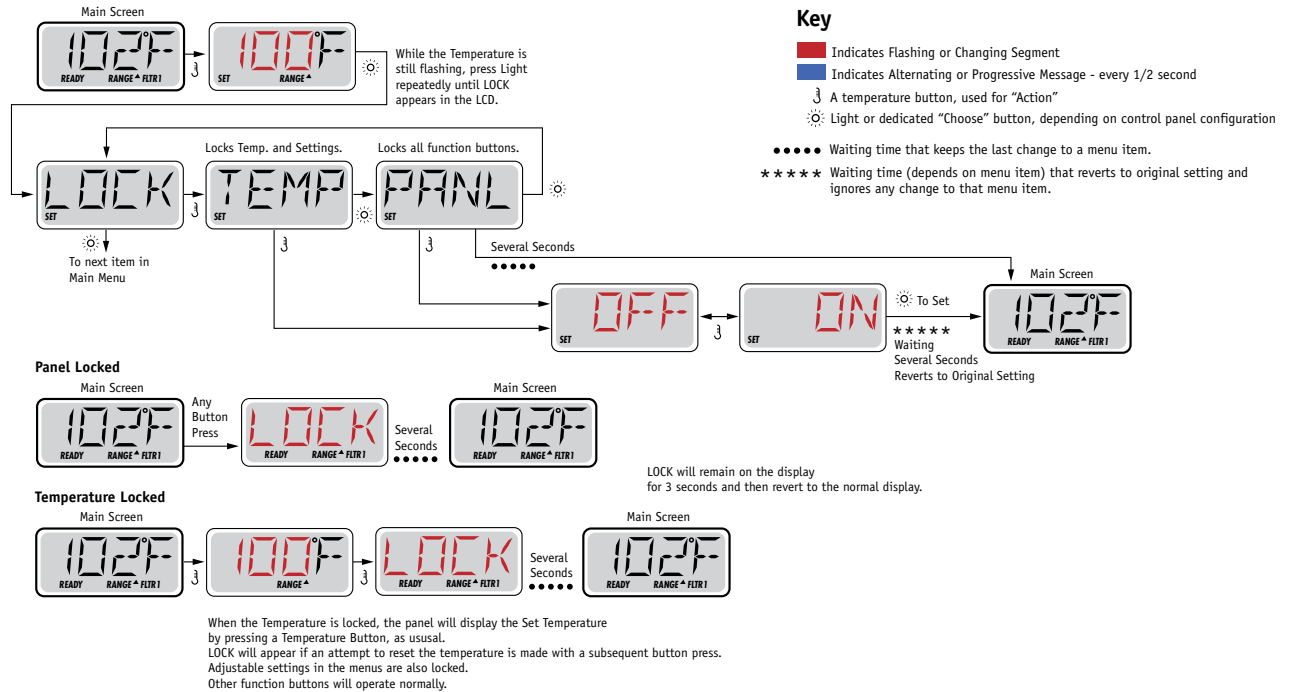

# Unlocking

This Unlock sequence may be used from any screen that may be displayed on a restricted panel.

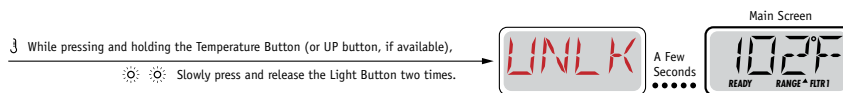

**NOTE:** If the panel has both an UP and a Down button, the ONLY button that will work in the Unlock Sequence is the UP button.

# Hold (Standby)

## Hold Mode – M037\*

Hold Mode is used to disable the pumps during service functions like cleaning or replacing the filter. Hold Mode will last for 1 hour unless the mode is exited manually.

## Drain Mode

Some spas have a special feature that allows a pump to be employed when draining the water. When available, this feature is a component of Hold Mode.

### Key

- Indicates Flashing or Changing Segment
- Indicates Alternating or Progressive Message - every 1/2 second
- ⏏ A temperature button, used for "Action"
- ☉ Light or dedicated "Choose" button, depending on control panel configuration
- Waiting time that keeps the last change to a menu item.
- \*\*\*\*\* Waiting time (depends on menu item) that reverts to original setting and ignores any change to that menu item.

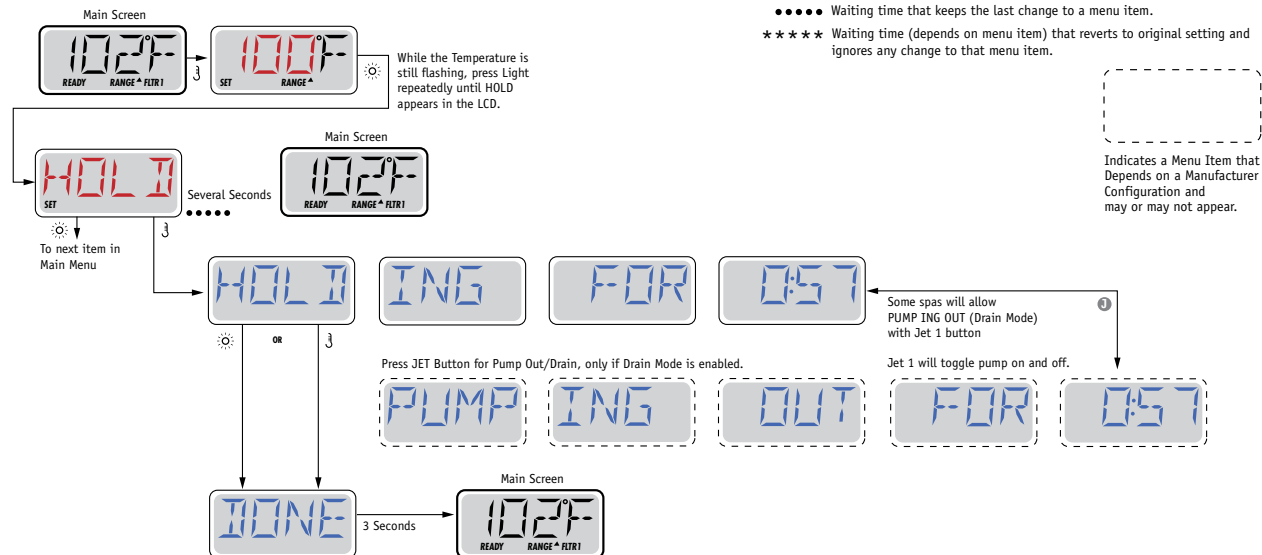

M037 is a Message Code. See Page 15.

Manufactured under one or more of these patents. U.S. Patents: 5332944, 5361215, 5550753, 5559720, 5,883,459, 6253227, 6282370, 6590188, 6976052, 6965815, 7030343, 7,417,834 b2, Canadian Patent: 2342614, Australian patent: 2373248 other patents both foreign and domestic applied for and pending.

# Adjusting Filtration

## Main Filtration

Filter cycles are set using a start time and a duration. Start time is indicated by an "A" or "P" in the bottom right corner of the display. Duration has no "A" or "P" indication. Each setting can be adjusted in 15-minute increments. The panel calculates the end time and displays it automatically.

### Key

- Indicates Flashing or Changing Segment
- Indicates Alternating or Progressive Message - every 1/2 second
- ⌋ A temperature button, used for "Action"
- ☼ Light or dedicated "Choose" button, depending on control panel configuration
- Waiting time that keeps the last change to a menu item.
- \*\*\*\*\* Waiting time (depends on menu item) that reverts to original setting and ignores any change to that menu item.

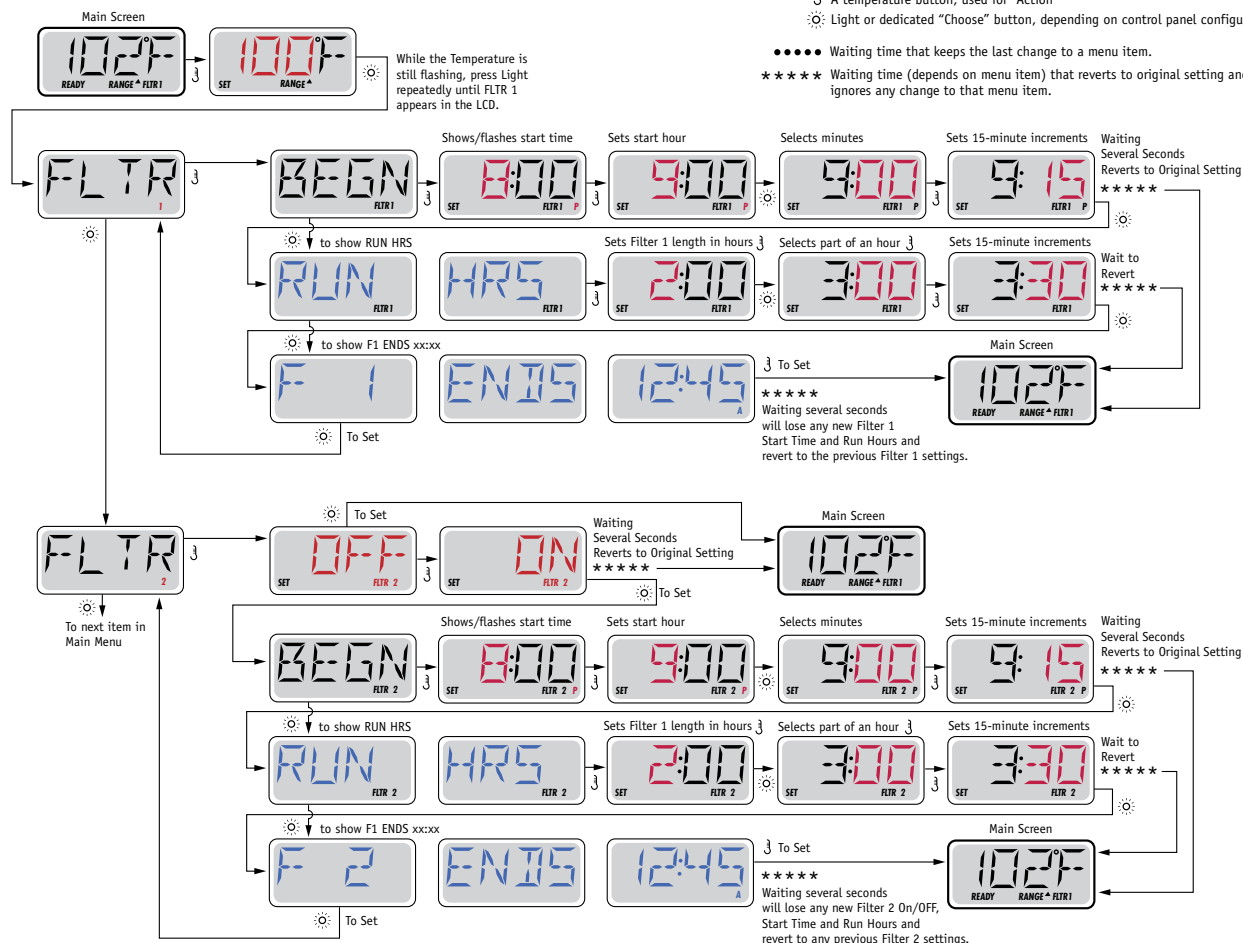

## Filter Cycle 2 - Optional Filtration

Filter Cycle 2 is OFF by default.

It is possible to overlap Filter Cycle 1 and Filter Cycle 2, which will shorten overall filtration by the overlap amount.

## Purge Cycles

In order to maintain sanitary conditions, secondary Pumps and/or a Blower will purge water from their respective plumbing by running briefly at the beginning of each filter cycle.

If Filter Cycle 1 is set for 24 hours, enabling Filter Cycle 2 will initiate a purge when Filter Cycle 2 is programmed to begin.

Manufactured under one or more of these patents. U.S. Patents: 5332944, 5361215, 5550753, 5559720, 5,883,459, 6253227, 6282370, 6590188, 6976052, 6965815, 7030343, 7,417,834 b2, Canadian Patent: 2342614, Australian patent: 2373248 other patents both foreign and domestic applied for and pending.

40940\_J

10

10-08-13

# Light Timer Programming

## Light Timer Option

If LITE TIMR does not appear in the Main Menu, the Light Timer feature is not enabled by the manufacturer.

When available, the Light Timer is OFF by default.

### Key

- Indicates Flashing or Changing Segment
- Indicates Alternating or Progressive Message - every 1/2 second
- ⌄ A temperature button, used for "Action"
- ☼ Light or dedicated "Choose" button, depending on control panel configuration
- Waiting time that keeps the last change to a menu item.
- \*\*\*\*\* Waiting time (depends on menu item) that reverts to original setting and ignores any change to that menu item.

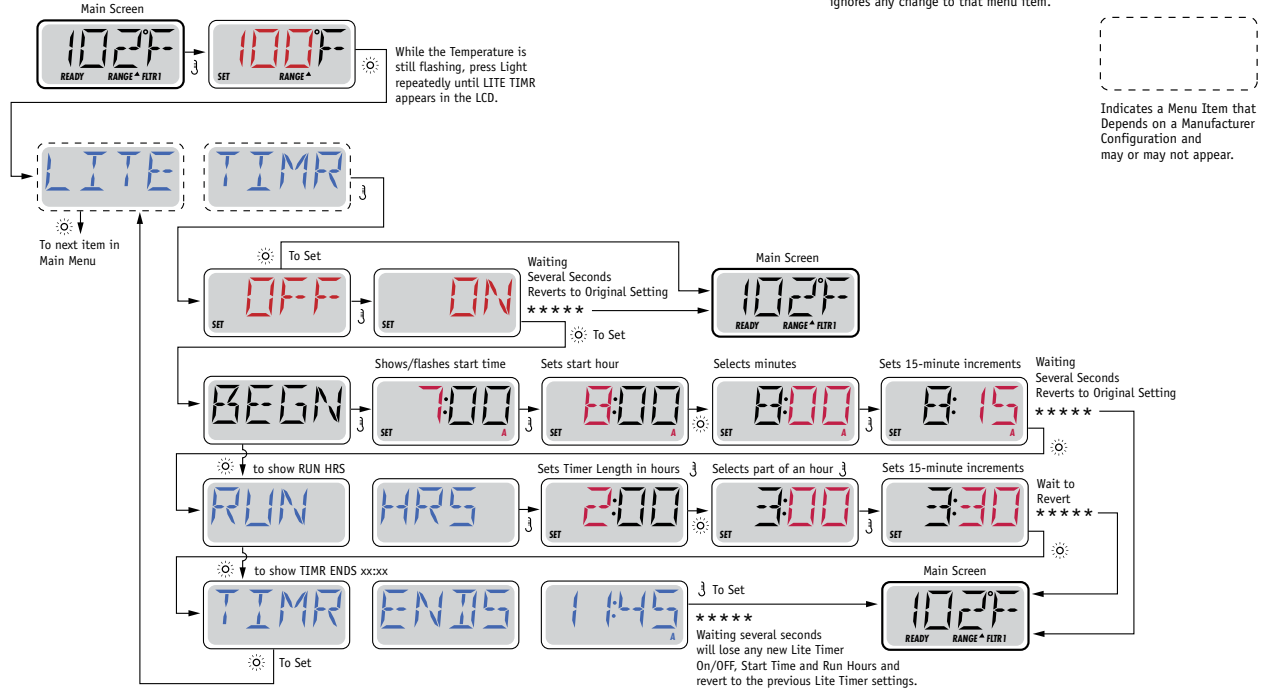

Manufactured under one or more of these patents. U.S. Patents: 5332944, 5361215, 5550753, 5559720, 5,883,459, 6253227, 6282370, 6590188, 6976052, 6965815, 7030343, 7,417,834 b2, Canadian Patent: 2342614, Australian patent: 2373248 other patents both foreign and domestic applied for and pending.

40940\_J

# Preferences

---

## **F / C (Temp Display)**

Change the temperature between Fahrenheit and Celsius.

## **12 / 24 (Time Display)**

Change the clock between 12 hr and 24 hr display.

## **RE-MIN-DERS (Reminders)**

Turn the reminder messages (like "Clean Filter") On or Off.

## **CLN-UP (Cleanup)**

Cleanup Cycle Duration is not always enabled, so it may not appear. When it is available, set the length of time Pump 1 will run after each use. 0-4 hours are available.

## **DOL-PHIN AD-DRES (Dolphin II and Dolphin III) Applies to RF Dolphin only. (This message may not appear depending on the configuration)**

When set to 0, no addressing is used. Use this setting for a Dolphin Remote which is factory set for no address by default. When set between 1 and 7, the number is the address. (See the Dolphin manual for details.)



# Preferences

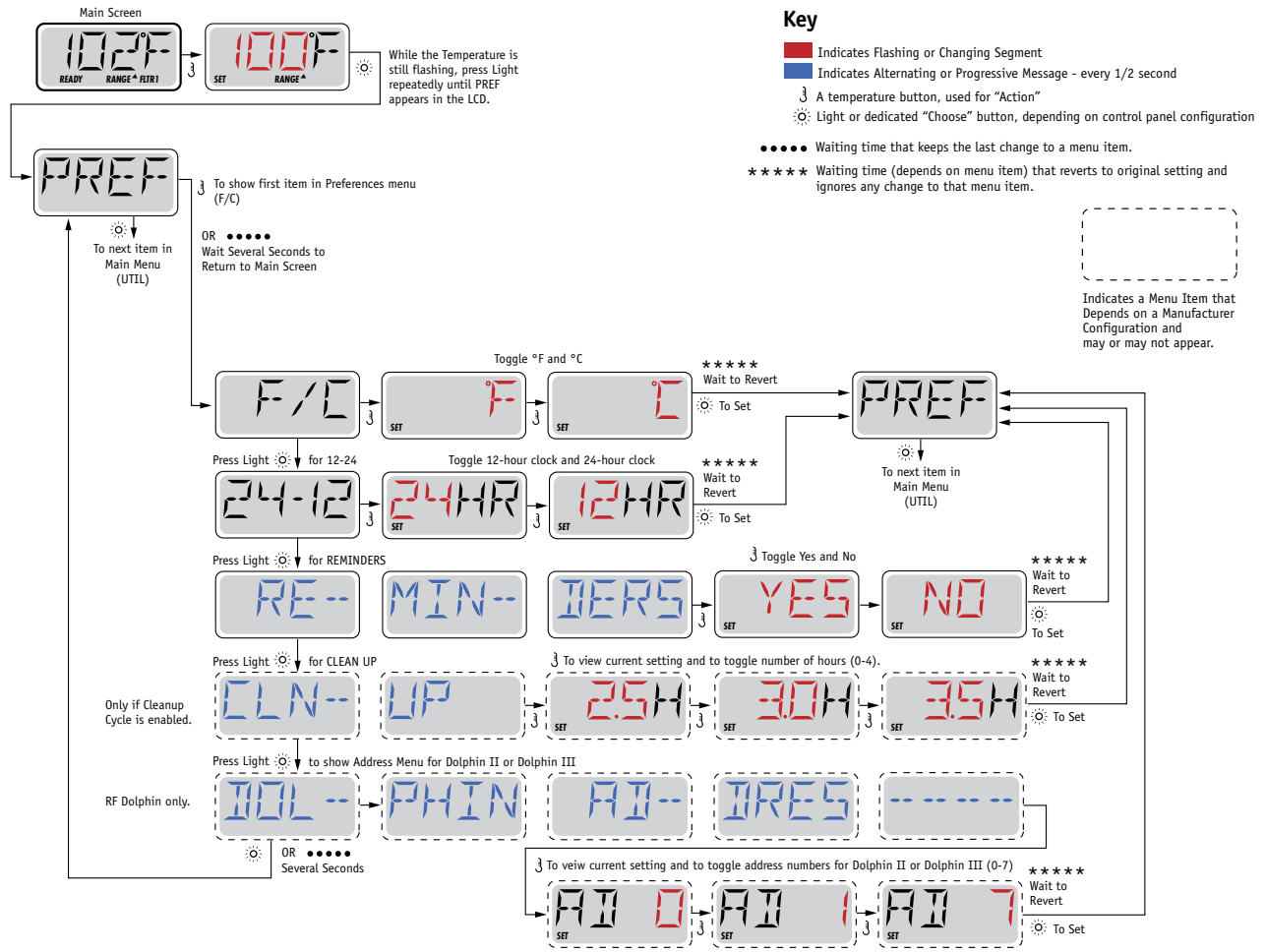

Manufactured under one or more of these patents. U.S. Patents: 5332944, 5361215, 5550753, 5559720, 5,883,459, 6253227, 6282370, 6590188, 6976052, 6965815, 7030343, 7,417,834 b2, Canadian Patent: 2342614, Australian patent: 2373248 other patents both foreign and domestic applied for and pending.

40940\_J

# Utilities and Information

---

## **INFO (System Information sub-menu)**

The System Information Menu displays various settings and identification of the particular system. As each item in the menu is highlighted, the detail for that item is displayed at the bottom of the screen.

## **SSID (Software ID)**

Displays the software ID number for the System.

## **MODL (System Model)**

Displays the Model Number of the System.

## **SETP (Current Setup)**

Displays the currently selected Configuration Setup Number.

## **SIG (Configuration Signature)**

Displays the checksum for the system configuration file.

## **Heater Voltage (Feature not used on CE rated systems.)**

Displays the operating voltage configured for the heater.

## **Heater Wattage as Configured in Software (CE Systems Only.)**

Displays a heater kilowatt rating as programmed into the control system software (1-3 or 3-6).

## **H \_ (Heater Type)**

Displays a heater type ID number.

## **SW \_ (Dip Switch Settings)**

Displays a number that represents the DIP switch positions of S1 on the main circuit board.

## **PANL (Panel Version)**

Displays a number of the software in the topside control panel.

# Additional Utilities

---

## Utilities

In addition to INFO, The Utilities Menu contains the following:

### **GFCI (GFCI Test)** **(Feature not available on CE rated systems.)**

GFCI Test is not always enabled, so it may not appear. This screen allows the GFCI to be tested manually from the panel and can be used to reset the automatic test feature. If the GFCI Test Feature is reset, the device will trip within 7 days. (See Page 17)

### **A / B (A/B Sensor Temperatures)**

When this is set to On, the temperature display will alternate to display temperature from Sensor A and Sensor B in the heater.

### **FALT LOG (Fault Log)**

The Fault Log is a record of the last 24 faults that can be reviewed by a service tech.

### **DEMO (Demo Mode)**

Demo Mode is not always enabled, so it may not appear. This is designed to operate several devices in a sequence in order to demonstrate the various features of a particular hot tub.

Manufactured under one or more of these patents. U.S. Patents: 5332944, 5361215, 5550753, 5559720, 5,883,459, 6253227, 6282370, 6590188, 6976052, 6965815, 7030343, 7,417,834 b2, Canadian Patent: 2342614, Australian patent: 2373248 other patents both foreign and domestic applied for and pending.

40940\_J

15

10-08-13

# Utilities

## Key

- Indicates Flashing or Changing Segment
- Indicates Alternating or Progressive Message - every 1/2 second
- ⌄ A temperature button, used for "Action"
- ☼ Light or dedicated "Choose" button, depending on control panel configuration
- Waiting time that keeps the last change to a menu item.
- \*\*\*\*\* Waiting time (depends on menu item) that reverts to original setting and ignores any change to that menu item.

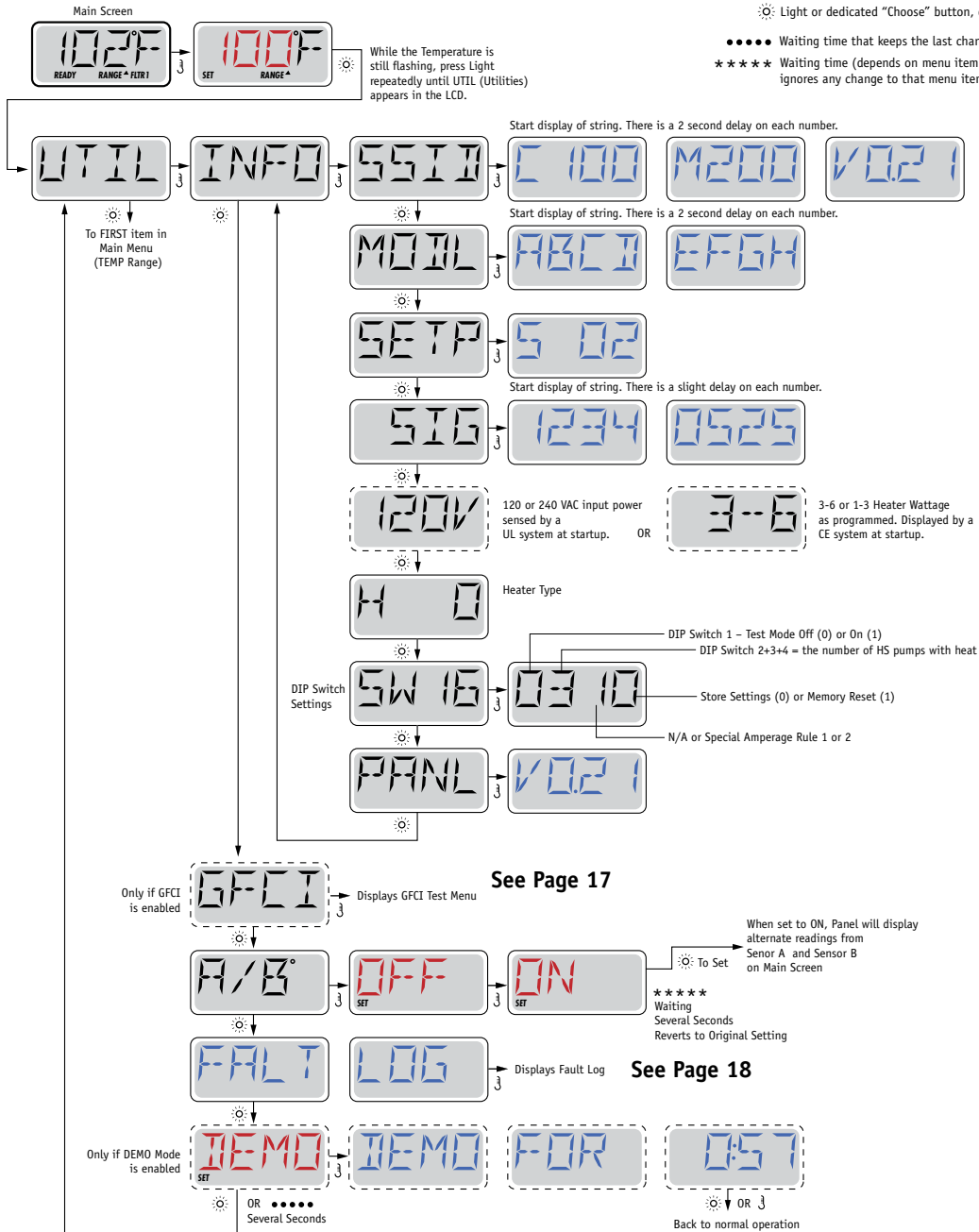

Manufactured under one or more of these patents. U.S. Patents: 5332944, 5361215, 5550753, 5559720, 5,883,459, 6253227, 6282370, 6590188, 6976052, 6965815, 7030343, 7,417,834 b2, Canadian Patent: 2342614, Australian patent: 2373248 other patents both foreign and domestic applied for and pending.

# Utilities – GFCI Test Feature

## Not Available on CE Rated Systems.

A GFCI is an important safety device and is required equipment on a hot tub installation.

Your spa may be equipped with a GFCI Protection feature. (UL rated systems only.) If your spa has this feature enabled by the manufacturer, the GFCI Trip Test must occur to allow proper spa function.

Within 1 to 7 days after startup, the spa will trip the GFCI to test it. (The number of days is factory programmed.) The GFCI must be reset once it has tripped. After passing the GFCI Trip Test, any subsequent GFCI trips will indicate a ground fault or other unsafe condition and the power to the spa must be shut off until a service person can correct the problem.

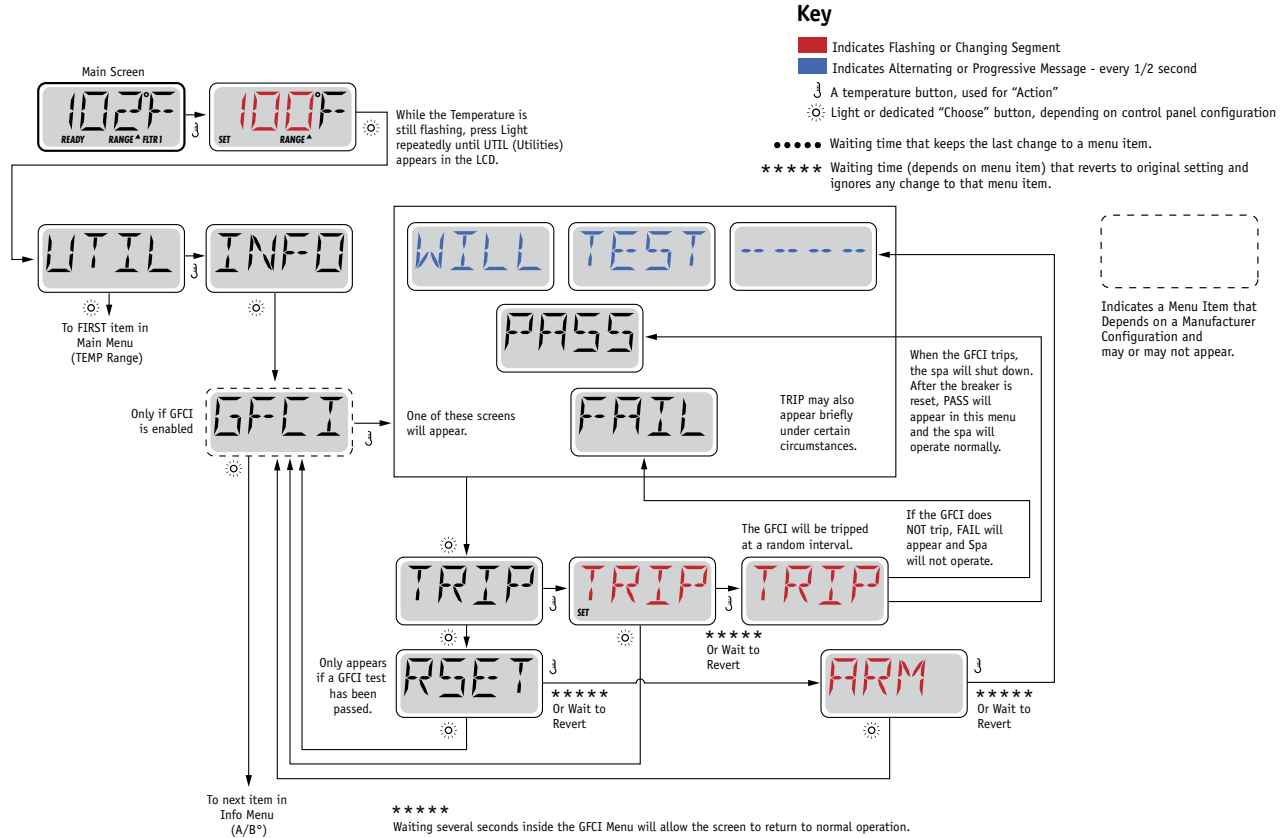

## Forcing the GFCI Trip Test

The installer can cause the GFCI Trip Test to occur sooner by initiating it using the above menu.

The GFCI should trip within several seconds and the spa should shut down. If it does not, shut down the power and manually verify that a GFCI breaker is installed and that the circuit and spa are wired correctly. Verify the function of the GFCI with its own test button. Restore power to the spa and repeat the GFCI Trip Test.

Once the GFCI is tripped by the test, reset the GFCI and the spa will operate normally from that point. You can verify a successful test by navigating to the above menu. PASS should appear after a temp button is pressed from the GFCI screen.

**The end-user must be trained to expect this one-time test to occur and how to properly reset the GFCI.**

## Warning:

If freezing conditions exist, a GFCI should be reset immediately or spa damage could result. The end user should always be trained to test and reset the GFCI on a regular basis.

Manufactured under one or more of these patents. U.S. Patents: 5332944, 5361215, 5550753, 5559720, 5,883,459, 6253227, 6282370, 6590188, 6976052, 6965815, 7030343, 7,417,834 b2, Canadian Patent: 2342614, Australian patent: 2373248 other patents both foreign and domestic applied for and pending.

# Utilities – Fault Log

## A Little History can tell a lot

The Fault Log stores up to 24 events in memory and they can be reviewed under the Fault Log Menu.

Each event captures a Fault Message Code, how many days have passed since the fault, Time of the fault, Set Temperature during the fault, and Sensor A and B temperatures during the fault.

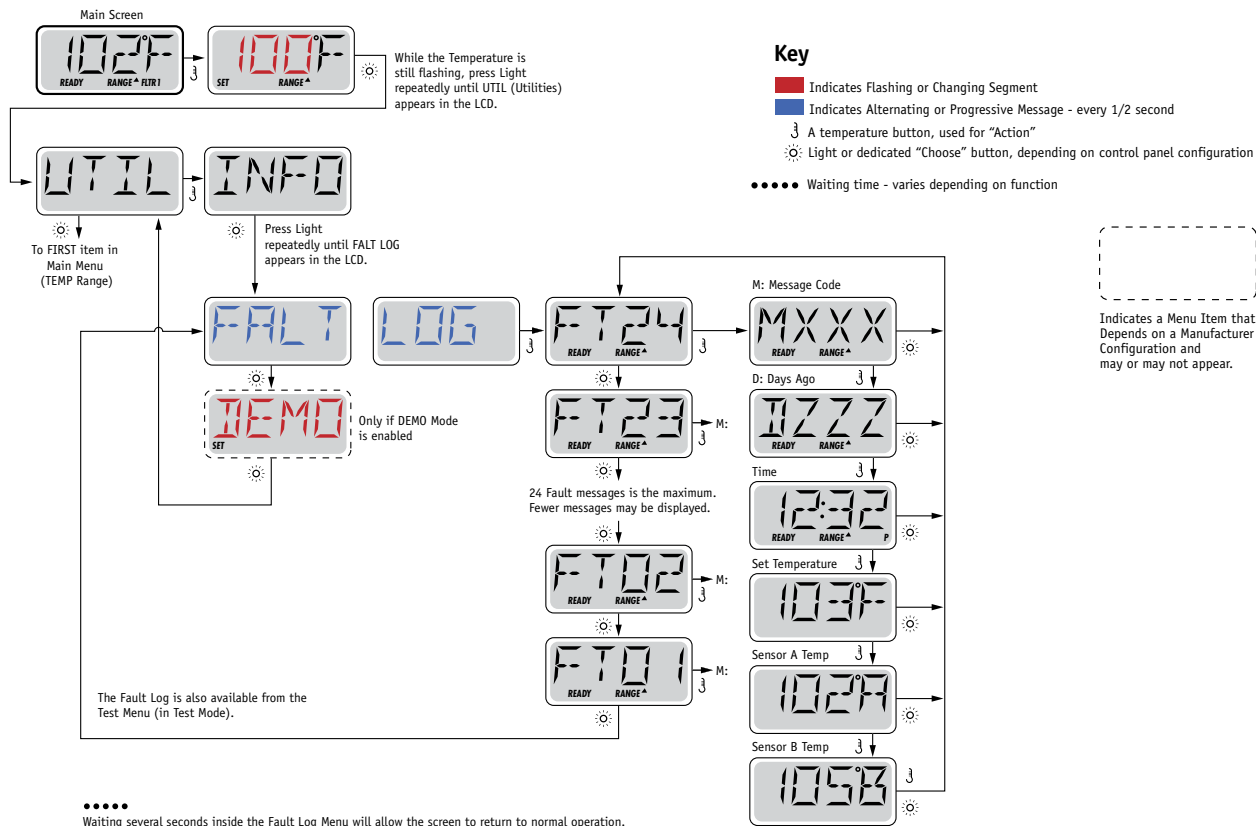

See following pages for various Message Codes and definitions.

Manufactured under one or more of these patents. U.S. Patents: 5332944, 5361215, 5550753, 5559720, 5,883,459, 6253227, 6282370, 6590188, 6976052, 6965815, 7030343, 7,417,834 b2, Canadian Patent: 2342614, Australian patent: 2373248 other patents both foreign and domestic applied for and pending.

# General Messages



## Priming Mode – M019

Each time the spa is powered up, it will enter Priming Mode. The purpose of Priming Mode is to allow the user to run each pump and manually verify that the pumps are primed (air is purged) and water is flowing. This typically requires observing the output of each pump separately, and is generally not possible in normal operation. Priming Mode lasts 4 minutes, but you can exit it earlier by pressing any Temp button. The heater is not allowed to run during Priming Mode.

NOTE: If your spa has a Circ Pump, it will turn on with Jets 1 in Priming Mode. The Circ Pump will run by itself when Priming Mode is exited.

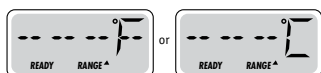

## Water Temperature is Unknown

After the pump has been running for 1 minute, the temperature will be displayed.



## Too Cold - Freeze Protection

A potential freeze condition has been detected, or the Aux Freeze Switch has closed, and all pumps and blower are activated. All pumps and blower are ON for at least 4 minutes after the potential freeze condition has ended, or when the aux freeze switch opens.

In some cases, pumps may turn on and off and the heater may operate during Freeze Protection. This is an operational message, not an error indication.



## Water is too Hot (OHS) – M029

One of the water temp sensors has detected spa water temp 110°F (43.3°C) and spa functions are disabled. System will auto reset when the spa water temp is below 108°F (42.2°C). Check for extended pump operation or high ambient temp.



## Safety Trip - Pump Suction Blockage\* – M033

The Safety Trip error message indicates that the vacuum switch has closed. This occurs when there has been a suction problem or a possible entrapment situation avoided. (Note: not all spas have this feature.)

M0XX numbers are Message Codes. See Page 15.

\* This message can be reset from the topside panel with any button press.

Manufactured under one or more of these patents. U.S. Patents: 5332944, 5361215, 5550753, 5559720, 5,883,459, 6253227, 6282370, 6590188, 6976052, 6965815, 7030343, 7,417,834 b2, Canadian Patent: 2342614, Australian patent: 2373248 other patents both foreign and domestic applied for and pending.

## Heater-Related Messages



### Heater Flow is Reduced (HFL) – M016

There may not be enough water flow through the heater to carry the heat away from the heating element. Heater start up will begin again after about 1 min. See “Flow Related Checks” below.



### Heater Flow is Reduced (LF)\* – M017

There is not enough water flow through the heater to carry the heat away from the heating element and the heater has been disabled. See “Flow Related Checks” below. After the problem has been resolved, you must press any button to reset and begin heater start up.



### Heater may be Dry (dr)\* – M028

Possible dry heater, or not enough water in the heater to start it. The spa is shut down for 15 min. Press any button to reset the heater start-up. See “Flow Related Checks” below.



### Heater is Dry\* – M027

There is not enough water in the heater to start it. The spa is shut down. After the problem has been resolved, you must press any button to reset and restart heater start up. See “Flow Related Checks” below.



### Heater is too Hot (OHH)\* – M030

One of the water temp sensors has detected 118°F (47.8°C) in the heater and the spa is shut down. You must press any button to reset when water is below 108°F (42.2°C). See “Flow Related Checks” below.



### A Reset Message may Appear with other Messages.

Some errors may require power to be removed and restored.

### Flow-Related Checks

Check for low water level, suction flow restrictions, closed valves, trapped air, too many closed jets and pump prime.

On some systems even when spa is shut down, some equipment may occasionally turn on to continue monitoring temperature or if freeze protection is needed.

\* This message can be reset from the topside panel with any button press.

Manufactured under one or more of these patents. U.S. Patents: 5332944, 5361215, 5550753, 5559720, 5,883,459, 6253227, 6282370, 6590188, 6976052, 6965815, 7030343, 7,417,834 b2, Canadian Patent: 2342614, Australian patent: 2373248 other patents both foreign and domestic applied for and pending.

40940\_J

20

10-08-13



# Sensor-Related Messages



## Sensor Balance is Poor – M015

The temperature sensors MAY be out of sync by 2°F or 3°F. Call for Service.



## Sensor Balance is Poor\* – M026

The temperature sensors ARE out of sync. The Sensor Balance is Poor fault has been established for at least 1 hour. Call for Service.



## Sensor Failure – Sensor A: M031, Sensor B: M032

A temperature sensor or sensor circuit has failed. Call for Service.

# Miscellaneous Messages



## No Communications

The control panel is not receiving communication from the System. Call for Service.



## Pre-Production Software

The Control System is operating with test software. Call for Service.



## °F or °C is replaced by °T

The Control System is in Test Mode. Call for Service.

\* This message can be reset from the topside panel with any button press.

Manufactured under one or more of these patents. U.S. Patents: 5332944, 5361215, 5550753, 5559720, 5,883,459, 6253227, 6282370, 6590188, 6976052, 6965815, 7030343, 7,417,834 b2, Canadian Patent: 2342614, Australian patent: 2373248 other patents both foreign and domestic applied for and pending.

## System-Related Messages



### Memory Failure - Checksum Error\* – M022

At Power-Up, the system has failed the Program Checksum Test. This indicates a problem with the firmware (operation program) and requires a service call.



### Memory Warning - Persistent Memory Reset\* – M021

Appears after any system setup change. Contact your dealer or service organization if this message appears on more than one power-up, or if it appears after the system has been running normally for a period of time.



### Memory Failure - Clock Error\* – M020 - Not Applicable on the BP1500

Contact your dealer or service organization.



### Configuration Error – Spa will not Start Up

Contact your dealer or service organization.



### GFCI Failure - System Could Not Test/Trip the GFCI – M036

NORTH AMERICA ONLY. May indicate an unsafe installation. Contact your dealer or service organization.



### A Pump Appears to be Stuck ON – M034

Water may be overheated. POWER DOWN THE SPA. DO NOT ENTER THE WATER. Contact your dealer or service organization.



### A Pump Appears to have been Stuck ON when spa was last powered – M035

POWER DOWN THE SPA. DO NOT ENTER THE WATER.

Contact your dealer or service organization.

\* This message can be reset from the topside panel with any button press.

Manufactured under one or more of these patents. U.S. Patents: 5332944, 5361215, 5550753, 5559720, 5,883,459, 6253227, 6282370, 6590188, 6976052, 6965815, 7030343, 7,417,834 b2, Canadian Patent: 2342614, Australian patent: 2373248 other patents both foreign and domestic applied for and pending.

40940\_J

22

10-08-13

# Reminder Messages

## General maintenance helps.

Reminder Messages can be suppressed by using the PREF Menu. See Page 11.

Reminder Messages can be chosen individually by the Manufacturer. They may be disabled entirely, or there may be a limited number of reminders on a specific model.

The frequency of each reminder (i.e. 7 days) can be specified by the Manufacturer.

Press a Temperature button to reset a displayed reminder message.



Alternates with temperature or normal display.

## Appears on a regular schedule, e.g. every 7 days.

Check pH with a test kit and adjust pH with the appropriate chemicals.



Alternates with temperature or normal display.

## Appears on a regular schedule, e.g. every 7 days.

Check sanitizer level and other water chemistry with a test kit and adjust with the appropriate chemicals.



Alternates with temperature or normal display.

## Appears on a regular schedule, e.g. every 30 days.

Clean the filter media as instructed by the manufacturer. See HOLD on page 6.



Alternates with temperature or normal display.

## Appears on a regular schedule, e.g. every 30 days.

The Ground Fault Circuit Interrupter (GFCI) or Residual Current Device (RCD) is an important safety device and must be tested on a regular basis to verify its reliability.

Every user should be trained to safely test the GFCI or RCD associated with the hot tub installation.

A GFCI or RCD will have a TEST and RESET button on it that allows a user to verify proper function.

## Warning:

If freezing conditions exist, a GFCI or RCD should be reset immediately or spa damage could result. The end user should always trained to test and reset the GFCI or RCD on a regular basis.

Manufactured under one or more of these patents. U.S. Patents: 5332944, 5361215, 5550753, 5559720, 5,883,459, 6253227, 6282370, 6590188, 6976052, 6965815, 7030343, 7,417,834 b2, Canadian Patent: 2342614, Australian patent: 2373248 other patents both foreign and domestic applied for and pending.

## Reminder Messages Continued

---

CHNG

WATR

Alternates with temperature or normal display.

### Appears on a regular schedule, e.g. every 90 days.

Change the water in the spa on regular basis to maintain proper chemical balance and sanitary conditions.

---

CLN

COVR

Alternates with temperature or normal display.

### Appears on a regular schedule, e.g. every 180 days.

Vinyl covers should be cleaned and conditioned for maximum life.

---

TRT

WOOD

Alternates with temperature or normal display.

### Appears on a regular schedule, e.g. every 180 days.

Wood skirting and furniture should be cleaned and conditioned per the manufacturers instructions for maximum life.

---

CHNG

FLTR

Alternates with temperature or normal display.

### Appears on a regular schedule, e.g. every 365 days.

Filters should be replaced occasionally to maintain proper spa function and sanitary conditions.

---

CHNG

CART

Alternates with temperature or normal display.

### As needed.

Install new mineral cartridge

# Warning! Qualified Technician Required for Service and Installation

## Basic Installation and Configuration Guidelines

Use minimum 6AWG copper conductors only.

Torque field connections between 21 and 23 in lbs.

Readily accessible disconnecting means to be provided at time of installation.

Permanently connected.

Connect only to a circuit protected by a Class A Ground Fault Circuit Interrupter (GFCI) or Residual Current Device (RCD) mounted at least 5' (1.52M) from the inside walls of the spa/hot tub and in line of sight from the equipment compartment.

CSA enclosure: Type 2

Refer to Wiring Diagram inside the cover of the control enclosure.

Refer to Installation and Safety Instructions provided by the spa manufacturer.

**Warning:** People with infectious diseases should not use a spa or hot tub.

**Warning:** To avoid injury, exercise care when entering or exiting the spa or hot tub.

**Warning:** Do not use a spa or hot tub immediately following strenuous exercise

**Warning:** Prolonged immersion in a spa or hot tub may be injurious to your health

**Warning:** Maintain water chemistry in accordance with the Manufacturers instructions.

**Warning:** The equipment and controls shall be located not less than 1.5 meters horizontally from the spa or hot tub.

## Warning! GFCI or RCD Protection.

The Owner should test and reset the GFCI or RCD on a regular basis to verify its function.

## Warning! Shock Hazard! No User Serviceable Parts.

Do not attempt service of this control system. Contact your dealer or service organization for assistance. Follow all owner's manual power connection instructions. Installation must be performed by a licensed electrician and all grounding connections must be properly installed.

## CSA Compliance/Conformité

### Caution:

- Test the ground fault circuit interrupter or residual current device before each use of the spa.
- Read the instruction manual.
- Adequate drainage must be provided if the equipment is to be installed in a pit.
- For use only within an enclosure rated CSA Enclosure 3.
- Connect only to a circuit protected by a Class A ground fault circuit interrupter or residual current device.
- To ensure continued protection against shock hazard, use only identical replacement parts when servicing.

- Install a suitably rated suction guard to match the maximum flow rate marked.

### Warning:

- Water temperature in excess of 38°C may be injurious to your health.
- Disconnect the electrical power before servicing.

### Attention:

- Toujours verifier l'efficacite du disjoncteur differentiel avant d'utiliser differentiel avant d'utiliser le bain.
- Lire la notice technique.
- Lorsque l'appareillage est installe dans une fosse, on doit assurer un drainage adequat.
- Employer uniquement a l'interieur d'une cloture CSA Enclosure 3.
- Connecter uniquement a un circuit protege par un disjoncteur differentiel de Class A.
- Afin d'assurer une protection permanente contre le danger de shock electrique, lors de l'entretien employer seulement des pieces de rechange identiques.
- Les prises d'aspiration doivent etre equipees de grilles convenant au debit maximal indique.

### Avertissement:

- Des temperatures de l'eau superieures a 38°C peuvent presenter un danger pour la sante.
- Deconnecter du circuit d'alimentation electrique avante l'entretien.

### Warning/Advertissement:

- Disconnect the electric power before servicing. Keep access door closed.
- Deconnecter du circuit d'alimentation electrique avant l'entretien. Garder la porte fermer.

## Connecting to a Device or Network

### 1 Direct connection

Range: About 20 feet  
Range limit: Limited to the range of the wi-fi module



#### HOW TO CONNECT TO IT:

Install the app on your phone or device -- see the following section "Installing the app".

### 2 Through home network with no internet access

#### Allows one local connection at a time

Range: About 50 feet  
Range limit: Limited to the range of your home router's signal



#### HOW TO CONNECT TO IT:

1. Install the app on your phone or device.
2. Exit the app and go to wi-fi settings on your phone or device.
3. Select and enable your local router.
4. Start the app. After you connect, select Settings on the home screen.
5. On the Settings screen, select Advanced, then on the Advanced screen, select Wi-fi Settings.
6. On the Wi-fi screen, select WPA. Then select the name of your home router from the drop-down menu.
7. Enter the SSID and Key for your router, tap Save and select OK twice.
8. Close the app and re-start it to connect to your home network.

### 3 Through a network with internet access, using Cloud connection or other hotspot connection

#### Allows unlimited simultaneous connections

Range: Worldwide  
Range limit: Limited to 3G / 4G / hotspot availability

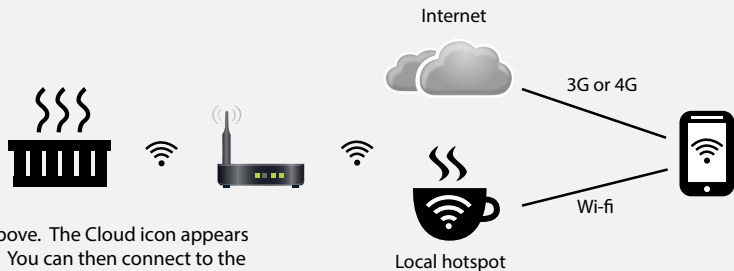

#### HOW TO CONNECT TO IT:

Follow connection instructions from section (2) above. The Cloud icon appears automatically when network connection is made. You can then connect to the spa's wi-fi module.

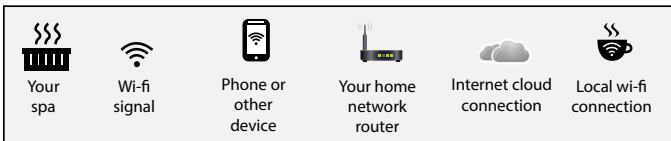

## Jets

Almost all of the jets in your spa are adjustable. Rotating the face of an adjustable jet to the left (counterclockwise) will decrease the amount of water flow through the jet. Rotating the face of an adjustable jet to the right (clockwise) will increase the amount of water flow through the jet. (See example shown here.)

Neck jets adjust in the opposite directions (counterclockwise to increase, clockwise to decrease).



# ATS Plus Therapy System



## Adjustable Therapy System

### Pump On / Off Button:

Press this button once to turn on the ATS pump. The pump will turn on full speed with letter "H" displayed in the seven segment LED, the Pump LED light on the control panel will appear and the back light will turn on if it was off previously. Press this button a second time to turn off the ATS pump, the Pump LED light, and clear the seven segment display. The ATS pump must be on before you can use any other features of this system.

### Pulse Mode Button:

Press this button once to turn on the pulse mode. The last pulse mode number will be displayed and the ATS pump will run in the pulse mode that it displays. There are total of 9 pulse modes and user can choose the Up or Down button to select the desired pulse mode. Press this button a second time to turn off pulse mode and return to normal pump on with letter "H" displayed. See the image for 9 pulse mode descriptions.

### Up / Down Buttons:

These buttons only activate when pulse mode is on. They allow you to cycle through 9 pulse modes. At the end of pulse mode 9, if the Up button is pushed the system will go to "DEMO" mode. In DEMO mode, the system will cycle through all 9 pulse modes with 30 seconds for each mode and flashing letter "d1" through "d9" while cycling through each pulse mode. At the end of demo pulse mode 9, the system will exit the demo mode and return to normal Pump On with letter "H" displayed.

### Time Out:

The Pump On will run for 15 minutes, then automatically shut off. If the Pulse Mode button is pressed during this time, the timer will reset and allow Pulse Mode to run for 15 minutes, then automatically shut off. For another 15 minutes session, press the Pump On and the Pulse Mode button. Back light will timeout 30 minutes after Pump Off.

### Pump Protection:

If the pump is getting too hot during pulse mode (or after stop), the Pulse Mode will stop and ATS system will automatically go to a cool down cycle. During cool down cycle, the pump will turn on full speed with flashing letter "C" displayed in the panel. The ATS system will run 5 minutes and then turn off. Pulse Mode is disabled during cool down cycle.

### Pump Purge:

To prevent water stagnation for a long time in the ATS system, the ATS system will purge water once a day. Every 24 hours from the last system run, the ATS system will turn on full speed for 20 seconds with flashing letter "P" displayed in the panel.

### ATS Sensor:

ATS sensor is used to monitor temperature to prevent ATS system from freezing or getting too hot. If temperature is too cold, the ATS system will turn on full speed with flashing letter "F" displayed in the panel. If it is too hot, the system will turn on full speed with flashing letter "C" displayed in the panel. In these cases, it will run until pump temperature goes back to normal and the system will shut down automatically.

If ATS sensor is not connected or not mounted to the system correctly, a flashing letter "E" will display in the panel when system is not running. With sensor error (flashing "E"), ATS system is still be able to operate normally but after the first 15 minutes of pulse mode, a flashing "L" will display in the panel. After the second 15 minutes of pulse mode, the system will force a cool down cycle for 30 minutes before user can use it again. There will be no freeze protection for sensor error and in some pulse modes the system will run very hot so user should fix the problem as soon as they can to enhance the pump life. ATS system has freeze protection that is activated at 45°F and will run until 50°F, then it will shut off.



- 1 Low rolling bursts
- 2 Medium continuous bursts
- 3 Accelerated continuous bursts
- 4 Swift rolling bursts
- 5 3 gentle bursts followed by 1 vigorous burst
- 6 Quick, powerful continuous bursts
- 7 Gentle, powerful alternating bursts
- 8 Medium low rolling bursts
- 9 Extended low rolling bursts

## Aquatic Air Therapy™ (AAT)

### AQUATIC AIR THERAPY™ JETS

The Aquatic Air Therapy™ (AAT) Jets in conjunction with the massage ring provides a massage therapy experience for sore muscles or aching joints (Available only in select areas of spa).



#### FLEX JET™

The Flex Jet™ delivers a gentle but strong stream of water to more delicate areas of the body including wrists, joints and extra sensitive muscles. Experience immediate alleviation from the massage ring included on the Flex Jet™.



#### DUO JET™

The Duo Jet™ is perfect for larger parts of your body including lower back, legs and shoulders. Place your back on the the Duo Jet™ for a complete rehabilitating massage therapy experience.



#### PRECISION JET™

The Precision Jet™ emits the perfect combination of air and water to target specific problematic areas while a soft massage ring provides relief on contact. Relieve muscle tension and soreness with the Precision Jet™.



#### AAT AIR CONTROL

The Aquatic Air Therapy™ has its own dedicated Air Control that allows you to adjust the air flow precisely to create your total spa therapy experience.

Ultimate Feet Therapy

## LED Lighting

Press the LIGHT button on the topside control panel to turn the spa light on. If your spa has perimeter LED lights, they will also light up at the same time as the spa light.

The LEDs operate in three modes:

- 1. Cycle:** When you continually press the LIGHT button, the LEDs will cycle through the three main LED colors (Red, Green, and Blue) or combinations of the three that produce the following colors: light green, purple, light blue, yellow, etc.

Each time you press the button, you immediately advance to the next color in sequence or eventually a different light pattern.

- 2. Flashing:** When you are cycling through all the colors, the next time you push the LIGHT button, the LED lights may start flashing. This is another normal operational pattern option.

- 3. Fading cycle:** The next phase of operation when you push the LIGHT button is a slow and/or fast fade random transition from one color to the next.

- If a spa is equipped with more than 100 points of light, the Slow Fading Cycle will flicker during a color change.
- Every air valve and water valve is equipped with 4 LED points.
- Every jet is equipped with 2 LED points.
- Perimeter LEDs take 9 points of light.
- The waterfall takes 4 points of light.

Spas with exterior corner LED lighting generally work in the same mode as described above. The variations in color and patterns provide you with multiple options to suit almost any lighting preference.



## Diverter Knobs

Diverter knobs are 1" and 2" knobs located around the top of your spa. They allow you to divert water through jets from one side of the spa to the other, or in most cases from floor jets to wall jets. This is accomplished by rotating the diverter knob to the left (counterclockwise), decreasing the amount of water flow through a section of jets. To increase the amount of water flow through the other section of jets, rotate the handle to the right (clockwise).



## Air Venturis

Air venturis are the 1" knobs located around the top of your spa. Each one will let you add a mixture of air with the jet pressure. This is accomplished by rotating the air venturi knob to the left (counterclockwise) to increase the amount of airflow through the jets. To decrease the amount of airflow through the jets, rotate the handle to the right (clockwise).



## Waterfalls

Some spa series include optional waterfalls. When the booster pump is on, rotate the dial on top (for the cascade waterfall) or turn the knob (for the hydro streamer -- see below).



## Hydro Streamer Waterfall

Your spa may include two to eight streamer waterfalls. When the booster pump is on, turn the 1" diverter knob to adjust the rate of flow to the waterfall jets.

The waterfall jet faces are not adjustable. Do not turn the jet faces because you may accidentally remove them.

Always shut off water to the hydro streamer jets before you place the cover on the spa. Water from the hydro streamer jets sprays in an arc that is higher than the top surface of the spa. When water from the hydro streamer jets sprays the bottom of the cover, it will collect and run to the edge of the spa and drip over the top.



# Water Clarity

This section is intended for new spa owners with no experience with water chemistry. Everyone's experience with maintaining water quality is different, but there are some general concepts you need to know.

Water maintenance is not difficult, although it requires regular attention. The most important thing to understand about taking care of your spa water is that preventive action is much easier than correcting water quality issues.

Before you begin, we recommend you become familiar with some water quality terms and their definitions (see next page).

Whether you're filling your spa for the first time (see page 7) or refilling it after draining it for regular maintenance (see page 86), start and maintain your spa water by following the plan we describe in this section.

## 1 Chemical Balance

See page 74 to learn how to balance your spa water.



You will need to test and adjust the chemical balance of your spa water. Although this is not difficult, it needs to be done regularly.

You need to test the level of calcium hardness, total alkalinity, and pH.

Spa owners with a bromine generator also need to check total dissolved solids and phosphates.

## 3 Filtration

See page 77 for filter cleaning instructions.



Cleaning your filter regularly is the easiest and most effective single thing you can do to keep your water clear.

A clogged or dirty filter will cause the heater and pump to work harder than they need to, possibly causing them to fail.

The spa's heating system will only function with the proper amount of water flow

through the system.

## 2 Sanitation and Shock

See page 76 to learn how to use sanitizer and shock.



Sanitizers kill bacteria and viruses and keep the water clean. A low sanitizer level will allow microbes to grow quickly in the spa water. We recommend using either chlorine or bromine as your sanitizer.

You also need to add shock to the water to stimulate the chemical sanitizer. How much you use and how often depend on frequency and intensity of use.

Spa owners with an ozonator also need to add sanitizer, although their requirements are different.

## 4 Regularity

See page 78 for the schedule of recommended maintenance.



Clear water requires regular maintenance. Establish a routine based on a regular schedule for your spa water maintenance.

Maintaining your water quality helps the enjoyment of your spa and extends your spa's life by preventing damage from neglect and chemical abuse.

## Water Quality Terms and Definitions

The following chemical terms are used in this section. Understanding their meaning will help you to better understand clear water maintenance. Words in bold type are defined in this table.

### Bromine / Bromamines

Bromine is an efficient sanitizer chemical for spas. When used as a **sanitizer**, bromine forms compounds called bromamines. Bromine can be added to the spa or automatically generated. See page 76 for discussion on **sanitizers**.

Bromamines are compounds formed when bromine combines with nitrogen from body oils, perspiration, etc. Unlike chloramines, bromamines have no pungent odor and are effective **sanitizers**.

### Chlorine / Chloramines

Chlorine is an efficient sanitizing chemical for spas. We recommend using sodium dichlor-type granulated chlorine because it is totally soluble and nearly **pH** neutral. When used as a **sanitizer**, chlorine forms compounds called chloramines. See page 76 for discussion on **sanitizers**.

Chloramines are compounds formed when chlorine combines with nitrogen from body oils, perspiration, etc. Chloramines can cause eye irritation as well as having a strong odor. Unlike **bromamines**, chloramines are weaker, slower **sanitizers**. To remove chloramines, see the description of **shock** below.

<b>Calcium Hardness</b>	Abbreviated as CH. Calcium hardness is a measure of the total amount of dissolved calcium in the water. Calcium helps control the <b>corrosive</b> nature of the spa's water and is why soft water is not recommended. The low CH level can cause <b>corrosion</b> to the equipment and can cause staining of the spa shell. See page 75 for testing for and balancing calcium hardness.
<b>Corrosion</b>	The gradual wearing away of metal spa parts, usually caused by chemical action. Generally, corrosion is caused by low <b>pH</b> or by water with levels of <b>TA, CH, pH</b> or sanitizer which are outside the recommended ranges.
<b>Dichlor</b>	Also called sodium dichlor. It is a type of chlorine and is frequently used when <b>shocking the water</b> . An effective <b>chlorine</b> -based powdered <b>oxidizer</b> and <b>sanitizer</b> . Dichlor works by oxidizing waste product in the water such as <b>bromamines</b> and <b>chloramines</b> and causing them to burn off.
<b>Monopersulphate or MPS</b>	Frequently used when <b>shocking the water</b> . An effective non-chlorine-based powdered <b>oxidizer</b> that works well with both <b>chlorine</b> and <b>bromine</b> . It works by oxidizing waste product in the water such as <b>bromamines</b> and <b>chloramines</b> and causing them to burn off.
<b>Oxidizer</b>	<b>Shocking the water</b> with an oxidizing chemical prevents the buildup of contaminants, maximizes <b>sanitizer</b> efficiency, minimizes combined <b>chlorine</b> and improves water clarity.
<b>Ozone</b>	Ozone is a powerful oxidizing agent which is produced in nature and artificially. Ozone forms no by-products of <b>chloramines</b> (ozone actually oxidizes chloramines) and will not alter the water's <b>pH</b> .
<b>pH</b>	The pH level is the measure of the balance between acidity and alkalinity. Low pH causes the water to be too acid, which will cause <b>corrosion</b> , whereas high pH causes the water to be too alkaline, which will cause <b>scaling</b> . See page 75 for testing for and balancing pH.
<b>ppm</b>	The abbreviation of "parts per million", the standard measurement of chemical concentration in water. Identical to mg/l (milligrams per liter).
<b>Sanitizer</b>	Sanitizer is a chemical added to the water to kill bacteria and viruses and keep the water clean. The two sanitizers we recommend are <b>chlorine</b> and <b>bromine</b> . See page 76 for discussion of sanitation.
<b>Scale</b>	Rough calcium-bearing deposits that can coat spa surfaces, heaters, plumbing lines and clog filters. Generally, scaling is caused by mineral content combined with high <b>pH</b> . Additionally, scale forms more readily at higher water temperatures.
<b>Shock</b>	Also called shocking the water, shock treatment, or superchlorination. Shocking the water is adding significant doses of <b>dichlor</b> or <b>MPS</b> to <b>oxidize</b> non-filterable organic waste and to remove <b>chloramines</b> and <b>bromamines</b> . Shock treatment breaks down organic waste contaminants which cause odor and cloudy water. See page 77 for discussion of shocking the water.
<b>Total Alkalinity</b>	Abbreviated as TA. Total alkalinity is the measure of the total levels of carbonates, bicarbonates, hydroxides, and other alkaline substances in the water. TA is important for <b>pH</b> control. If the TA is too low, the <b>pH</b> will fluctuate out of control, and if it is too high, the <b>pH</b> becomes difficult to stabilize. See page 74 for testing for and balancing total alkalinity.
<b>Trichlor</b>	Used as a pool <b>sanitizer</b> . NEVER use trichlor in a spa. Trichlor is extremely acidic and will lower the <b>pH</b> , causing corrosion to equipment. Using trichlor will void your warranty.

## Water Testing Methods

There are two testing methods to choose from:

Test strips are a convenient testing method commonly used by spa owners.



The reagent test kit is a method which provides a high level of accuracy but is more expensive and more difficult to use.

## Adding Chemicals to the Spa Water

**IMPORTANT:** All spa water chemicals, including MPS (shock), chlorine, granulated pH increaser or decreaser, granulated total alkalinity increaser, calcium hardness increaser, liquid stain and scale inhibitor, and liquid de-foamer must always be added directly into or in front of the filter compartment while a jet pump is running, and it must run for a minimum of ten minutes.

1. Fold back the cover.
2. Press the **Jets** or **Jets 1** button.
3. Carefully measure the recommended amount of chemical and slowly pour it into the filter area. Use care not to splash chemicals on your hands, in your eyes, on the spa surface, or on the siding.
4. Close the spa cover.

**Warning:** High sanitizer levels can cause discomfort to the user's eyes, lungs and skin. Always allow the sanitizer level to fall to the recommended range before using the spa.

**IMPORTANT NOTE REGARDING SHOCK TREATMENT:** After administering shock to your spa, leave the cover open for a minimum of 20 minutes to allow the oxidizer gas to vent. A high concentration of trapped oxidizer gas which may exist as a result of the shock treatment (not daily sanitation) may eventually cause discoloration or vinyl degradation to the bottom of the cover. This type of damage is considered chemical abuse and is not covered under the terms of the limited warranty.

### 1. Balancing the Water Chemistry Levels

Maintaining spa water chemistry can be tricky, especially since there are many methods of keeping your water clear and clean. Follow the maintenance schedule on page 78 to determine how often you should test your water.

We do not recommend any brand of chemical. See page 78 for a table of common chemicals used in spas and their generic equivalents.

See a spa dealer for guidance and recommendations on spa chemicals and supplies. Various chemicals often sold under brand names, but a spa dealer can advise you on generic chemicals that are often much less costly than proprietary brands.

#### Balancing the Total Alkalinity (TA)

Total Alkalinity is a measure of the total levels of carbonates, bicarbonates, hydroxides, and other alkaline substances in the water. TA is referred to as the water's "pH buffer". In other words, it's a measure of the ability of the water to resist changes in pH level.

If the TA is too low, the pH level will fluctuate widely from high to low. Fluctuations in pH can cause corrosion or scaling of the spa components. Low TA can be corrected by adding sodium carbonate (pH/Alkalinity Up).

If the Total Alkalinity is too high, the pH level will tend to be high and may be difficult to bring down. It can be lowered by using sodium bisulfate (pH/Alkalinity Down).

Once the TA is balanced, it normally remains stable, although the addition of more water with a high or low alkalinity will raise or lower the TA reading of the water.

When the Total Alkalinity is within the recommended range, proceed to the next step.

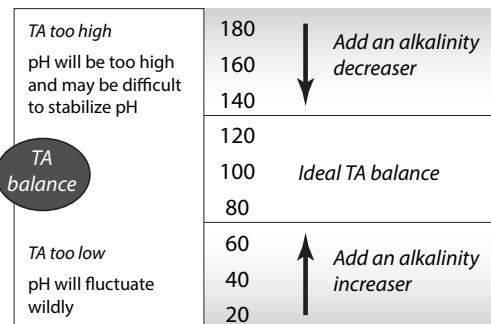

### Balancing the Calcium Hardness (CH)

Calcium Hardness is a measure of the total amount of dissolved calcium in the water. Calcium helps control the corrosive nature of the spa's water. That's why calcium-low water (commonly known as "soft" water) is not recommended. It is very corrosive to the equipment, and can cause staining of the spa shell.

If the CH is too high (commonly known as "hard water"), formation of scale on the spa's shell surface and equipment can result. You can use a generic calcium remover to remove hardness from water. CH can also be decreased by dilution – a mixture of 75% hard and 25% soft water will usually yield a reading within the correct range. If soft water is not available or practical for you, a stain and scale inhibitor should be added to the spa water, according to label instructions.

If the CH is too low add CH Increaser.

Once the CH is balanced, it normally remains stable, although the addition of more water with a high or low calcium content will raise or lower the CH reading of the water.

When the CH is within the recommended range, proceed to the next step.

<i>CH too high</i> Causes scale to deposit on spa and equipment	275	↓ <i>Dilute the spa with soft water</i>
	250	
<b>CH balance</b>	225	<i>Ideal CH balance</i>
	200	
	175	
	150	
<i>CH too low</i> Causes equipment corrosion	125	↑ <i>Add a calcium hardness increaser</i>
	100	
	75	

### Balancing the pH

The pH level is the measure of acidity and alkalinity. Values above 7.8 are alkaline; those below 7.2 are acidic. Maintaining the proper pH level is extremely important for optimizing the effectiveness of the sanitizer, maintaining water that is comfortable for the user, and preventing equipment deterioration.

If the spa water's pH level is too low, the following may result:

- The sanitizer will dissipate rapidly.
- The water may become irritating to spa users.
- The spa's equipment may corrode.

If the pH is too low, it can be increased by adding sodium hydrogen carbonate (pH/Alkalinity Up) to the spa water.

If the pH level is too high, the following may result:

- The sanitizer is less effective.
- Scale will form on the spa shell surface and the equipment.
- The water may become cloudy.
- The filter cartridge pores may become obstructed.

If the pH is too high, it can be decreased by adding sodium bisulfate (pH/Alkalinity Down) to the spa water.

NOTE: After adding sodium hydrogen carbonate or sodium bisulfate, wait two hours before testing the water for pH. Measurements taken too soon may not be accurate.

It is important to check the pH on a regular (weekly) basis. The pH will be affected by the bather load, the addition of new water, the addition of various chemicals, and the type of sanitizer used.

When the pH is within the recommended range, proceed to sanitation.

<i>pH too high</i> Too alkaline, causes scaling	8.2	↓ <i>Add a pH decreaser</i>
	8.0	
	7.8	
<b>pH balance</b>	7.6	<i>Ideal pH balance</i>
	7.4	
	7.2	
	7.0	
<i>pH too low</i> Too acidic, causes corrosion	6.8	↑ <i>Add a pH increaser</i>
	6.6	
	6.6	

## 2. Sanitation and Shock

Sanitizers kill bacteria and other organic waste by breaking them down to non-harmful levels which are filtered out. Before you fill your spa, you need to decide which chemical sanitizer you wish to use. Consult your Cal Spas dealer for the right decision with regards to your lifestyle and spa usage.

We recommend either **bromine** or **chlorine** as your sanitizer. Both work well when maintained regularly.



**DO NOT use Trichlor. Trichlor is very acidic and the hot temperature of the spa causes it to dissolve too quickly. It will cause damage to your spa and will void your warranty.**

Whichever plan you decide on, follow it completely and don't take shortcuts. It will provide you with clean, safe, clear spa water with a minimum of effort. Spa owners with an ozonator still need to use a chemical sanitizer. See page

81 for a description of how the ozonator works.

Whenever you test your chemical levels, your test strip will likely have a test for chlorine or bromine. Make sure your sanitizer falls within the range shown below.

Testing For:	Ideal Range (ppm)	
	Minimum	Maximum
<b>Chlorine Level</b>		
Without ozonator	3.0	5.0
With ozonator	2.0	4.0
<b>Bromine Level</b>		
Without ozonator	6.7	11.0
With ozonator	5.7	10.0

### Starting and Maintaining Sanitizer Levels

Sanitizing your spa with chlorine or bromine is very similar. Each sanitizer has its advantages and disadvantages.

**Bromine:** Whereas chlorine can sometimes cause offensive odors and skin irritation, bromine is less likely to do so. Additionally, unlike chlorine, when bromine combines with bather waste and other contaminants in the water, it remains a very effective sanitizer. Bromine is also far less pH-dependent than chlorine. **Always remember that bromine by itself is not a sanitizer, and it needs to be activated by shock in order to be effective.**

**Chlorine:** The most commonly recognized sanitizer is chlorine. However, the effectiveness of chlorine depends heavily on the pH level of the spa water. In order to get the most effective and economical benefit of chlorine, you must maintain a consistent pH level of between 7.2 to 7.6. A disadvantage of using chlorine is that when chlorine combines with bather waste and other contaminants in the water, not only does it lose its sanitizing ability, it can cause odors and irritate eyes and skin.

After you choose a sanitizer, you will need to establish a baseline and maintain it regularly.

Starting with fresh water:

1. Establish a baseline by adding either granulated chlorine or bromine.
  - Use half an ounce of chlorine for every 500 gallons of water.
  - Use half an ounce of bromine for every 100 gallons of water.
2. Run the jets for 10 minutes.
3. Test the water. Make sure the pH, TA, and CH levels all fall within the ranges shown on the previous page. Make adjustments where they are needed.
4. At this point, if you use bromine, it is not yet activated and **it will not sanitize the water**. You need to shock-oxidize the spa water. Depending on the size of your spa, add one to two ounces of shock. You can use any kind of shock you want.
5. Test the water again. When the water is balanced, your spa is ready to use.

Note: If you choose to use bromine, we do not recommend using a floater. You have more control over the bromine level by adding bromine as needed. For more discussion on this, see page 79, "Common Water Chemistry Questions".

## Shocking the Water

In addition to using a chemical sanitizer, you will periodically need to shock the water. Shocking the water helps remove burned-out chemicals, bacteria, and other organic material from your spa's water and improves your sanitizer's effectiveness.

Do not use chlorinating shock, which will damage your spa's jets and pump seals. Only use an oxidizer shock. It can be used with either chlorine or bromine sanitizers.

Add two ounces of oxidizer shock per 500 gallons once a week, after heavy bather loads, or if water has a strong odor.

Spa must be running with all of the jets on high for 30 minutes with the cover open. If necessary, repeat oxidizer shock in 30 minute intervals.

## 3. Filtration

The filter is the part of your spa that removes the debris from the water and needs to be cleaned on a regular basis to maximize your spa's filtering performance and heating efficiency.

**It is extremely important that you never run the spa without a filter. There is a possibility that debris may be sucked into the plumbing through the filter well.**

### Cleaning the Filter

In addition to spraying off the filter weekly to remove surface debris, your filter should be deep cleaned periodically to dissolve scale and particles that get lodged deep within the filter fibers and impede the filtration process. Even if the filter looks clean, scale and particles can clog the fibers and prevent water from flowing through the filter resulting in the most common spa problem—no heat, caused by a dirty filter.

We recommend you clean your filter at least once a month, possibly every two weeks depending on how frequently you use your spa, and replace it once a year or as necessary. See page 87 for instructions on removing and cleaning the filter.

## 4. Regularity (Maintenance Schedule)

<b>Prior to each use</b>	Test the spa water. Adjust chemical levels as necessary. Shock the water by adding ½ teaspoon of sodium dichlor per 250 gallons or 1 teaspoon of MPS per 250 gallons.
<b>After each use</b>	Add an ounce of oxidizer after heavy bather loads (see page 77 on shocking the water).
<b>Once a week</b>	Check the filter well and inside the filter pipe for leaves and foreign matter. Test the spa water. Adjust chemical levels as necessary. Shock the water by adding ½ teaspoon of sodium per 250 gallons or 3 teaspoons of MPS per 250 gallons. If your water source is high in calcium, add stain and scale preventer.
<b>Every two to four weeks</b>	Deep clean your spa's filter (see page 87). How often you clean your filter depends on how much you use your spa. There is no harm in frequently cleaning your filter and will only help your spa's efficiency.
<b>Every two to four months</b>	Change the spa water. How often you change the water depends on how much you use the spa. When you change the water, you will need to: <ul style="list-style-type: none"> <li>• Clean and polish the acrylic surface (see page 89)</li> <li>• Clean and treat the spa cover and pillows (see page 89)</li> <li>• Deep clean the filter (see page 87)</li> <li>• Refill your spa (see page 7)</li> </ul>
<b>Each time you refill the spa</b>	Follow the section "Filling and Powering Up Your Portable Spa" on page 7.
<b>Once a year</b>	Replace filter cartridges if the pleats appear frayed (see page 87).

## Generic Names for Chemicals

Water Chemistry		
Common name	Usual chemical name	Common brand names
pH Up	sodium hydroxide	pH Increaser, pH Up, pH Plus, pH Booster
pH Down	sodium bisulfate sodium bicarbonate (baking soda) sodium carbonate	pH Decreaser, pH Down, pH Minus, pH Subtractor, Dry Acid
Alkalinity increaser	sodium carbonate sodium bicarbonate (baking soda)	Alkalinity Increaser, Alkaline Up
Alkalinity decreaser	sodium bisulfate	Alkalinity Decreaser, Alkaline Down
Calcium increaser	calcium chloride	Calcium Increaser, Calcium Up, Calcium Plus, Hardness Increaser
Calcium decreaser	N/A To decrease calcium hardness, drain several gallons of water from the spa and refill using a mixture of 75% hard water and 25% soft water, or use a stain and scale inhibitor.	



Sanitizers		
Common name	Usual chemical name	Common brand names
Chlorine	sodium dichlor	Both chlorine and bromine are available under numerous brand names
Bromine	sodium bromide	

Shock		
Common name	Usual chemical name	Common brand names
MPS	monopersulphate	MPS Shock, Oxy-Spa, SeaKlear
Dichlor	sodium dichlor	Dichlor Shock

Note: Dichlor (chlorine) is both a sanitizer and a shock. Monopersulphate (MPS), when used as a shock, can be purchased alone as non-chlorinated shock or combined with dichlor, which makes it significantly more effective than MPS alone.

Other chemical additives		
Common name	Usual chemical name	Common brand names
Stain and scale inhibitor	These are usually proprietary chemical formulations and cannot be purchased as a single generic chemical.	Metal Stain Gone, Scale Inhibitor, Stain and Scale Preventer, Stain and Scale Defense
Foam inhibitor		Foam Gone, Foam Down, Defoamer
Clarifier		Water Brite, Spa Bright, Water Clarifier, Clear Water, Natural Clarifier, Brite & Clear

**Do NOT use these in your spa:**

- Sodium hypochlorite (household bleach)
- Trichlor
- Chemical floaters
- Bromine tablets
- Muriatic acid
- Borax or boric acid in any form, including brand names such as 20 Mule Team Borax or generic as sodium tetraborate
- Cyanuric acid, also called sun protector or chlorine protector

## Common Water Chemistry Questions

**Question:** Why is the use a floater not recommended to sanitize my spa water?

**Answer:** We do not recommend the use of a floater for three reasons:

- The floater is unable to control the rate at which the sanitizer is dissolved into the water. When a floater is first placed in a spa, the sanitizer level can be extremely high. High sanitizer levels can chemically burn or discolor the spa's shell or the underside of the cover. Then, after a period of time, the sanitizer level dispensed by the floater will fall to near zero. A low sanitizer level will allow viruses, bacteria or algae to grow.
- Floaters tend to stay in one area of the spa most of the time, causing this area to be exposed to extreme sanitizer levels.
- The floater may allow pieces of the highly concentrated sanitizer to fall out and settle on the floor or seat of the spa shell. These pieces of sanitizer will chemically burn (blister) the spa shell. Although your spa shell is specifically designed to resist the effects of spa chemicals, no spa surface can withstand this type of highly concentrated chemical. Remember, chemical abuse is specifically not covered under the terms of the warranty.

**Question:** When I open my spa, I smell chlorine. How do I get rid of this smell?

**Answer:** There are two types of chlorine in your spa. The first is the Free Available Chlorine, which is the chlorine available to sanitize your spa. This free Available Chlorine does not have an odor. The second is Chloramine, which is residue from chlorine already expended. Chloramines have a strong chlorine odor. The smell from Chloramines can be eliminated by shocking the water. If you smell chlorine in the water, your spa is reminding you to add a shock treatment.

**Question:** Why can't I fill my spa with soft water?

**Answer:** Soft water is essentially the same as regular water, except that most or all of the calcium has been replaced by sodium. Soft water may be corrosive to the heater and other components. Replacement of spa components damaged by soft water is extremely expensive.

**Question:** I am trying to reduce the number of chemicals to which my family is exposed. Do I really need to use so many chemicals and in such large amounts?

**Answer:** While over-exposure to any chemical can be unhealthy, many low levels of chemicals are effective and beneficial. In the case of spa water, the chemicals we recommend are needed to protect the user from water-borne pathogens (disease-causing microbes) and to prevent corrosion of spa components.

**Question:** Why isn't water chemistry damage covered by the warranty?

**Answer:** The chemical levels and water quality of the water in the spa are under your direct control. With proper basic care, the spa will provide many years of hot water relaxation. If you are unsure about any chemical or its usage in the spa, contact your spa dealer.

## Do's and Don'ts

- DO add all chemicals slowly into or in front of the filter compartment with the jet pump operating for ten minutes.
- DO use special care if using baking soda to clean either the interior or exterior plastic surfaces.
- DO use only a granular form of bromine sanitizer.
- DON'T use swimming pool (muriatic) acid to lower pH.
- DON'T splash pH increaser additives on the siding.
- DON'T use compressed sanitizers.

The use of bromine sticks or tablets in floaters, which may become trapped in a lounge or cooling seat (or sink to the spa floor), have been shown to cause discoloration of or surface distress to a spa's shell.

- DON'T use a floater type sanitization system as a low or no maintenance solution to your spa maintenance program.

Floating dispensers can become trapped in one area and cause an over-sanitization (or chemical burn) of that particular area.

If the dispenser setting is too high, the high concentration can discolor the spa shell and damage the underside of the cover.

Automatic floating dispensers have a tendency to either over-brominate or under-brominate as the rate of erosion varies greatly. Damage to the spa and cover can occur very quickly.

- DON'T use a sanitizer which is not designed for spas.
- DON'T use household bleach (liquid sodium hypochlorite).
- DON'T broadcast or sprinkle the chemicals onto the water surface. This method may cause chemically-induced spa surface blistering (chemical abuse).

## Bather Load

"Bather Load" is the term used to describe the number of people using a spa, combined with the length of usage, and the frequency of usage. All these factors have a great effect on the spa water. The higher the bather load, the more chemicals need to be added and a longer filtration time will be needed.

Recommendations are designed for spas with average bather load (3 to 4 people, 15 minutes of usage, three times a week at 100 degrees) If your bather load exceeds these guidelines, and you experience water quality problems, increase the amount of filtration first, (go to the next higher filtration number) then if water quality is still not adequate, consult the advice of your Cal Spas dealer for additional chemical or system recommendations. Be sure to give them your bather load information.

## Ozonator

The ozone generator releases ozone into the spa water. You will still need to test for chlorine or bromine and occasionally replenish it to return the sanitizer level to the baseline. See page 83.

For spas without a circulation pump, pump 1 will run at low speed and the ozonator will run during filtration. You will need to increase your filtration to a minimum of six hours per day.

For spas with a circulation pump, the ozonator will run with the circulation pump.

The spa's control system is factory-programmed with one filter cycle that will run in the evening when energy rates are often lower. The time and duration of the filter cycle can be set according to your needs. In addition, a second filter cycle can be enabled. Filtration time may need to be increased with heavy bather load.

See instructions for setting filtration cycles on page 26.

Always make sure water diverter valves are turned all the way to the left or right and never left in the center position during filtration cycles. When the diverter valve is in the center position, there is not enough suction from the pump in order to inject ozone into the spa. The ozonator will generate ozone, but it will not be injected into the water.

## Troubleshooting Water Clarity Problems

Problem	Probable Causes	Possible Solutions
<b>Cloudy Water</b>	Dirty filter	Clean filter and run jet pump
	Excessive oils / organic matter	Shock spa with sanitizer
	Improper sanitization	Add sanitizer
	Suspended particles / organic matter	Adjust pH and/or alkalinity to recommended range
	Overused or old water	Drain and refill the spa
<b>Water Odor</b>	Excessive organics in water	Shock spa with sanitizer
	Improper sanitization	Add sanitizer
	Low pH	Adjust pH to recommended range
<b>Chlorine Odor</b>	Chloramine level too high	Shock spa with sanitizer
	Low pH	Adjust pH to recommended range
<b>Musty Odor</b>	Bacteria or algae growth	Shock spa with sanitizer – if problem is visible or persistent, drain, clean and refill the spa
<b>Organic Buildup / Scum Ring Around Spa</b>	Buildup of oils and dirt	Wipe off scum with clean rag – if severe, drain the spa, use a spa surface and tile cleaner to remove the scum and refill the spa
<b>Algae Growth</b>	High pH	Shock spa with sanitizer and adjust pH
	Low sanitizer level	Shock spa with sanitizer and maintain sanitizer level
<b>Eye Irritation</b>	Low pH	Adjust pH
	Low sanitizer level	Shock spa with sanitizer and maintain sanitizer level
<b>Skin Irritation / Rash</b>	Unsanitary water	Shock spa with sanitizer and maintain sanitizer level
	Free chlorine level above 5 ppm	Allow free chlorine level to drop below 5 ppm before spa use
<b>Stains</b>	Total alkalinity and/or pH too low	Adjust total alkalinity and/or pH
	High iron or copper in source water	Use a stain and scale inhibitor
<b>Scale</b>	High calcium content in water – total alkalinity and pH too high	Adjust total alkalinity and pH – if scale requires removal, drain the spa, scrub off the scale, refill the spa and balance the water
		Use a stain and scale inhibitor

# Bromine Generator

The bromine generator automatically generates and releases free bromine into the spa water. You will still need to test for bromine and occasionally adjust it to return the bromine level to the baseline.

## Start-up/Operating Instructions

Be certain that you start with a clean spa. It should be free of contaminants and other residues that can accumulate on the sides and/or around the jets. It is also important to only use spa cleaning products that have **no phosphates** or phosphonic acids since phosphates will deplete free bromine and are super-food for algae. Always start your spa with a clean filter before filling with water.

If the water source is "well water" or a non-municipal water source, have your water tested for Total Dissolved Solids (TDS) and metals. Water with high TDS is likely to have higher metal content and will need a metal remover to decrease the metals and ensure a successful start. This test can be done by your local spa dealer. The ideal range for your start-up TDS is between 50 and 200 ppm - mg/L. If TDS from your source water is above 500 ppm, a metal remover is strongly recommended.

DO NOT FILL THE SPA WITH SOFT WATER.

- Using your PURE FILL Spa Pre-Filter, fill your spa with water to the recommended level (six inches below the lip of the spa) and DO NOT FILL WITH WATER FROM A "RESIDENTIAL WATER SOFTENER."
- Before starting the system, balance your water chemistry to ensure a successful start up. Ideal ranges are as follows:

	Ideal Range	
	Minimum	Maximum
pH	7.2	7.6
Total alkalinity	80 ppm	120 ppm
Calcium hardness	150 ppm	250 ppm
Phosphates	0 ppb	30 ppb

Use the phosphate test kit included with your system. Bromide residuals will be significantly reduced if phosphate levels are high. If phosphates are detected, purchase a phosphate remover and follow the directions accordingly. **Any** phosphates in your spa will reduce bromine levels.



- Determine the level of "NaBr" (Sodium Bromide) required for your spa size. NaBr should be added at a rate of 1.2 lbs per 100 gallons or approximately 1300-1500 ppm.

**Example:** For a 500 gallon spa add approximately 6 lbs of NaBr. **1.2 lbs x (5) 500 gallons = 6lbs NaBr.**

- Turn the jets on high speed. Sprinkle the NaBr across the surface of the water to evenly distribute the NaBr in the spa and circulate for 30 minutes.
- Test the Sodium Bromide concentration with the Tru-Blu NaBr test kit. The correct amount of NaBr will secure a reading of between 1300-1500 ppm.
- Adjust the filtration time to circulate for 8 hours every 24 hours on a 2 speed pump.
- For a spa between 300-500 gallons, start at a power level of "6" and then press the "boost" feature. This will accelerate the production of bromine for 8 hours. Wait for proper bromine levels before entering the spa.
- Always keep your bromine level between 3-5ppm. Test the bromine level after 24 hours and adjust the power setting accordingly. An occasional heavier bather load may require the "boost" feature.

## Maintaining the Bromine Level

Always keep your spa or hot tub water in balance. Maintaining the pH and the alkalinity is part of being a spa owner.

The bromine generator requires you to determine your power setting based upon your circulation time and your spa usage. It requires a minimum of eight hours of circulation per day. If the spa is not circulating, the bromine generator is not generating bromine. If you find that you are having trouble maintaining the desired level, make sure the spa is circulating the required amount.

A spa that is frequently used will require a higher power setting. If you have a bromine reading that is too high or too low, adjust the **DECREASE / INCREASE** control accordingly. Depending on the amount usage, circulation time, and type of spa, each spa owner's setting will be different.

The bromine generator can go up to 12 months before a drain and fill is required, unlike non-equipped spas that require it every three months. This is because the bromine generator does not add unwanted chemical by-products like traditional chemicals do.

Sodium bromide is not the only contributor to the TDS count in your water. Over time, the TDS count in your water will rise (from such things as residuals from other chemicals and minerals, and unfilterable material). Test the TDS every few months to make certain it stays within range.

Shower prior to entering any hot tub or spa. This will help prevent phosphate contamination and reduce the demand on the bromine.

Shocking your tub is recommended after heavy bather load.

## Intelligent Controller Codes for the Bromine Generator



**LC** (Low Conductivity) will appear when the unit detects that the conductivity is below the minimum level. At start-up, you will experience this if you have not added the Sodium Bromide. Check the Sodium Bromide level in the water and add the appropriate amount per your spa. If the NaBr level is correct, the cell may be experiencing scaling. In this case, you will want to clean the cell. Please consult with your spa dealer for further information.



**bSE** (Boost) will appear when the BOOST feature is on. Depressing this key once will increase the bromine production to twice that of the last bromine production setting for the next *accumulated eight hours of pump circulation time*. The BOOST cycle should be depressed after heavy bather load or usage.



**OE** (Open Element) will appear if the system controller is unable to detect a connection to the electrode cell. You may see this if the electrode is not connected properly, there is inadequate water flow, or the cell is not functioning due to unknown circumstances. This may require that the cell be evaluated and possibly cleaned of scale build-up or even replaced. If this happens, please consult with your spa dealer.



**HC** (High Current) will appear when the TDS (Total Dissolved Solids) is too high resulting in High Current at the electrode cell. If this reading appears at or near start up of your system, check your source water for TDS and proper NaBr readings. If this reading appears after an extended period of operation, draining 25% of the water and refilling can help reduce TDS levels. If "HC" remains present, consult with your spa dealer for a comprehensive water analysis and recommended course of action.

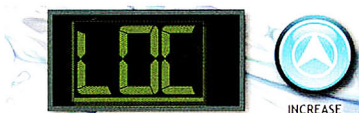

**LOC**: Press increase for 3 seconds to unlock

**LOC** (Locked) Your TopSide controller includes a "LOC" feature which ensures that the system is "Locked" when not being utilized to manage your Spa's water. Your system will automatically produce bromine when necessary. This feature is simply for your protection. In order to "Unlock" simply depress the "increase" key on your unit for 3 seconds.

## Removing and Reseating the Pillows

You can remove the pillows for cleaning and maintenance quickly and easily. This method works for all types of pillows.

Grab the lower edge of the pillow with both hands firmly and pull up. As you do this, the pillow inserts will pop out of the holes.

Reseat the pillows by aligning the pillow inserts with the holes and striking the pillow hard enough to insert the pegs back into the holes.

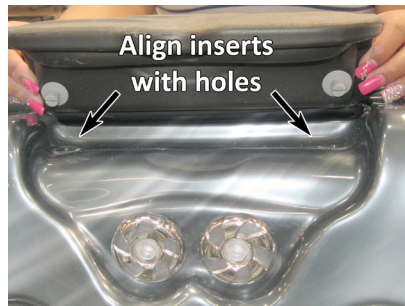

## Jet Removal and Replacement

Jets can be easily removed for cleaning.

### Screw-in jet removal

Grasp the outer rim of the jet and turn it counter-clockwise. The jet will unscrew from the fitting until it is free.

To replace the jet, place it in the fitting and turn it clockwise until it is snug in place and it can be rotated freely about half a turn. Do not overtighten the jet.

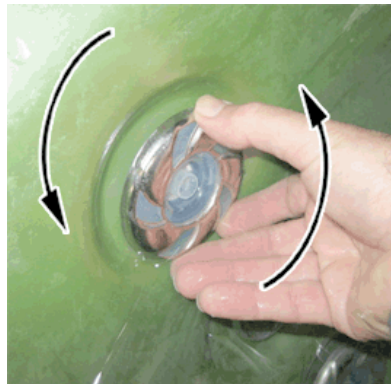

### Snap-in SQR jet removal

Grasp the outer rim of the jet and turn it counter-clockwise until it completely stops. You may feel it slightly loosen pop out a bit from the fixture. Pull the jet out from the jet fixture. The jet will be very snug and may require some force to remove it. DO NOT PRY OUT JETS.

To replace any jet, place it in the fitting and turn it clockwise until it snaps in and can be rotated freely about half a turn. Do not overtighten the jet.



## Draining Your Portable Spa

Your spa should be drained every four to six months for cleaning and maintenance and refilled with fresh tap water. See page 89 for instructions on cleaning the shell, cover, and pillows. See page 7 for instructions on refilling your spa. Before you begin, turn off power to the spa at the breaker and remove all filters.

### 1. Locate your drain.

#### *For spas with drain inside the spa*

Using a Phillips screwdriver, remove the screws to the access panel and open it. Locate hose ending with the  $\frac{3}{4}$  inch hose-bib fixture as shown below.



#### *For spas with cabinet-mounted drain*

Pull the knob out of the cabinet. The cabinet drain is screwed into the drain pull knob.



### 2. Remove the cap.

Make sure the valve is in the closed position, then unscrew and remove the cap. Unscrew the cap.

#### *For spas with drain inside the spa*

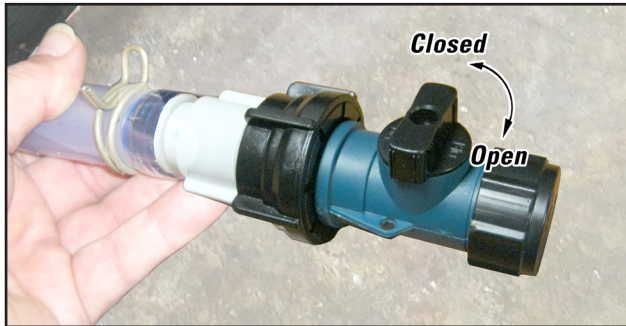

#### *For spas with cabinet-mounted drain*

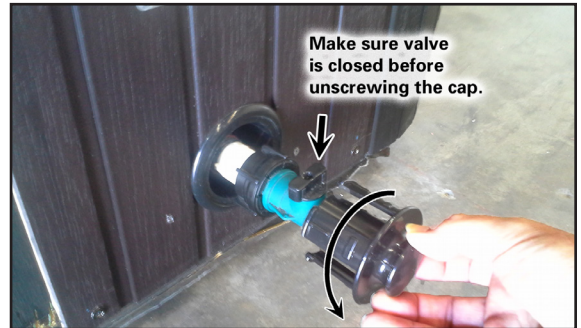

### 3. Connect valve to a garden hose.

Attach a garden hose to the hose-bib fixture. Place the other end of the garden hose where you would like the water to drain.

### 4. Drain the spa.

Turn the valve on the hose-bib fixture to open the drain. When the spa has drained completely, turn the valve on the hose-bib fixture, remove garden hose, and replace the cap.

#### *For all spas*

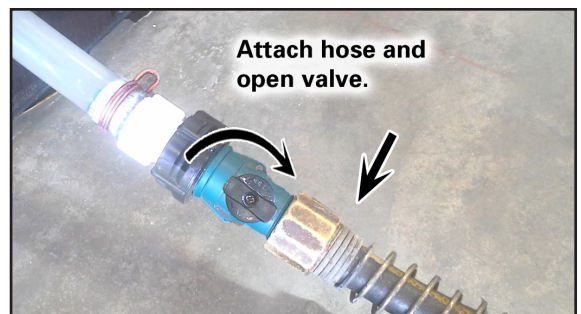



## Winterizing (Cold Climate Draining)

In many areas of the country, the temperature drops below 32°F (0°C). We recommend that you always have your spa full of water and running at normal spa temperatures (80°F to 100°F, 26.7°C to 37.8°C). This will help reduce the risk of freezing in your spa and your spa's equipment.

**Warning: If you find the need to drain your spa, be aware of the potential of freezing in your spas equipment and plumbing. Even if the directions below are followed perfectly, there is no guarantee that your spa will not suffer freeze damage. Freeze damage is not covered by your warranty.**

1. Remove the filter baskets and filters.
2. Drain your spa completely as described in the instructions above.
3. Vacuum water from the spa's main drain and from the jets with a wet/dry vacuum.
4. Open the bleeder valves on the pumps.
5. Disconnect the unions from both sides of all pumps.
6. Blow any remaining water out of the jets and equipment area with the wet/dry vacuum.
7. When the spa has completely finished draining, close the bleeder valves and re-connect the unions on all pumps. Replace the filters and filter baskets.
8. Cover your spa with a good spa cover and an all-weather tarp to ensure that neither rain nor snow enters the spa.

## Cleaning and Replacing the Filter

Filtration is one of the most important steps you can take to ensure clean, clear water. It is far less expensive to fix water clarity problems by filtering your spa than by using excessive amounts of chemicals, excessive filtration times, or by water replacement.

See the section "Cleaning the Filter" on page 77 for more information.

**Set the spa in HOLD MODE before you remove the filter. HOLD MODE pauses all spa operations for service functions like cleaning or replacing the filter. See page 29 for instructions on using HOLD MODE.**

1. Remove the filter by unscrewing it and pulling it up and out.
2. Place the dirty filter into a bucket of water deep enough to cover the filter. Add 8 oz. of liquid filter cleaner to the bucket of water.

**Note:** It is a good idea to keep a spare filter to use in the spa while the dirty filter is being deep cleaned. This way, you can rotate the filters and both will last longer.

3. Soak the filter for a minimum of 24 hours.
4. Spray the filter with a water hose. Spray each pleat carefully.
5. Reinstall the filter. Do not overtighten.

## Spa Cover

Important! Keep the spa covered when not in use!

- Covered spas will use less electricity in maintaining your set temperature.
- Covering your spa will protect your spa's finish from the sun's ultraviolet rays.
- You are required to keep the spa covered to maintain warranty coverage.

- Covering your spa helps prevent children from drowning in the spa.

See the manual enclosed with your cover for instructions on mounting the locks and how to lock and unlock the cover.

In addition, while the spa cover is rigid, it is not designed to support any weight. Therefore, as a safety precaution and to preserve the life of your cover, you must not sit, stand, or lie on it, nor should you place objects of any kind on top of it.



### IMPORTANT! LOCKING HARDWARE ENCLOSED Parts Installation Instructions:

- 1.- Place cover on spa. Be sure it is correctly positioned.
- 2.- Position the tie-down hardware (attached to the straps of your cover) on the side of the spa so they are easily reached by the cover tie-downs straps.
- 3.- With the straps pulled taut (not overly tight) mark the location for screw placement.
- 4.- Attach hardware with the screws provided.
- 5.- Keep cover fastened down at all times when not in use. Locking hardware may be locked with a key (provided).

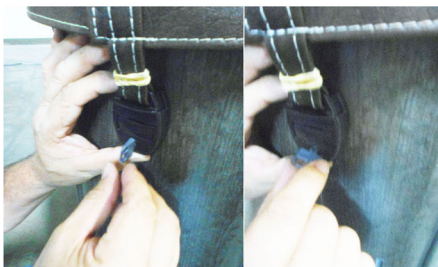

**UNLOCKED  
POSITION**

**LOCKED  
POSITION**



**WARNING  
AVOID  
DROWNING  
RISK**

FAILURE TO FOLLOW INSTRUCTIONS MAY RESULT IN INJURY OR DROWNING  
NON-SECURED OR IMPROPERLY SECURED COVERS ARE A HAZARD.  
REMOVE COVER COMPLETELY BEFORE ENTRY OF BATHERS.  
ENTRAPMENT POSSIBLE.  
KEEP COVER ON SPA AND LOCKED WHEN NOT IN USE

## Vacation Care

You can leave your spa unattended for up to two weeks if you follow these instructions.

**ALWAYS lock your cover using the cover locks if you plan to be away from home and the spa is filled with water.**

1. Select the Low Range temp choice used for vacation mode.
2. Following the water quality instructions starting on page 72, adjust the pH.
3. Shock the water (add either chlorine or bromine sanitizer).
4. When you return, check and adjust the pH and shock the water.

If you will not be using your spa for longer than 14 days and a spa maintenance service is not available, we strongly recommend you drain or winterize your spa.

# Cleaning Your Spa

## Spa Cover and Pillows

Due to the constant punishment your spa cover and pillows receive, you should protect them by applying a vinyl and leather cleaner as part of your monthly maintenance plan. Use a product that is specifically designed to protect spa covers and pillows from chemical and ultraviolet light damage without leaving an oily residue behind that is normally associated with common automotive vinyl protectants.

**Warning: Do not** use automotive vinyl protectants on spa covers or pillows. These products are generally oil-based and will cause severe water clarity issues that are difficult to correct.

## Spa Shell

Each time you drain your spa, before you refill it you should clean your spa shell with an all-purpose cleaner and apply a coat of surface protectant.

Use a low detergent, non-abrasive cleaner specifically formulated to clean the spa without damaging its acrylic finish.

Use a non-oil based surface protectant that is specifically formulated to protect the spa's finish from the chemicals and minerals associated with normal spa use.

# Using the Freedom Sound System

The Freedom Sound System™ entertainment option contains a Bluetooth-enabled speaker system that is available for certain Cal Spa models. Any Bluetooth-enabled device can be used to play audio through your spa.

Before you can use the sound system, you need to pair the Bluetooth module with your device. The Bluetooth module is installed within the spa cabinet. Everything can be done with your device. The example shown below is from an iPhone device. Your device may appear differently. Before you begin, make sure Bluetooth is enabled on your device.

1. Select Bluetooth from your device's option list.
2. Select **SWA8-6BT...** from the list of available devices to pair.
3. Your iPhone device will ask for a code: the code is 0000.
4. Allow your device to pair with the spa's Bluetooth module.
5. When the devices have been connected, the device **SWA8-6BT...** will be highlighted.

Only one Bluetooth device can be paired with the Freedom Sound System™ at any time.

(For Android users, the systems will pair automatically - no code is needed.)

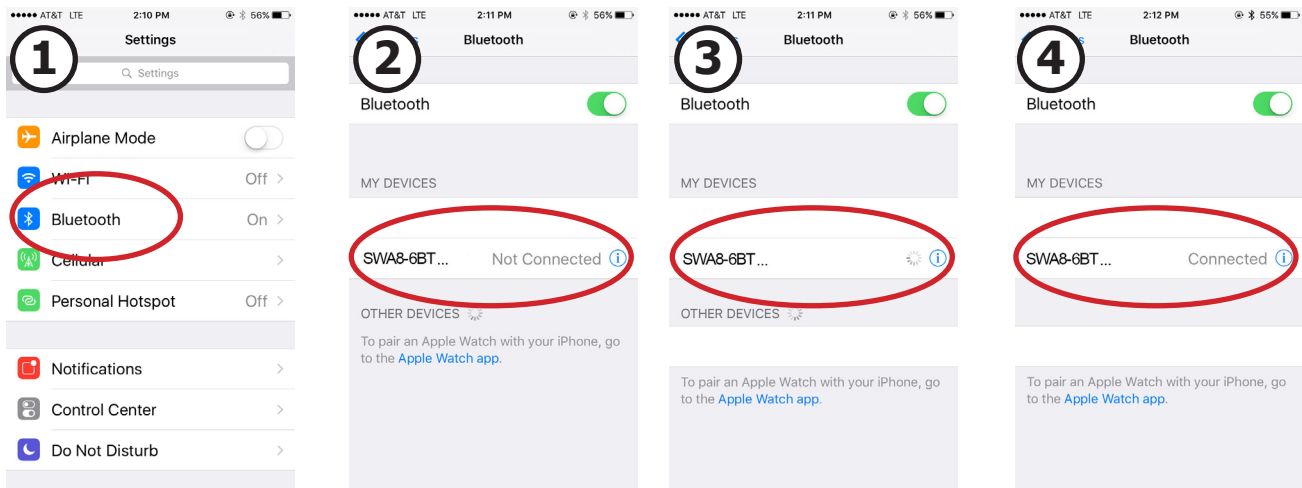

Once your device is paired and connected, all sounds from your device will be played through the sound system, including system sounds and telephone.



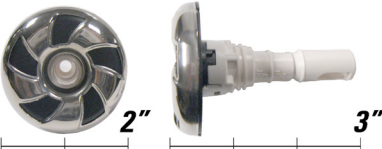

# Appendix

Please visit [www.quickspaparts.com](http://www.quickspaparts.com) to order your replacement parts.

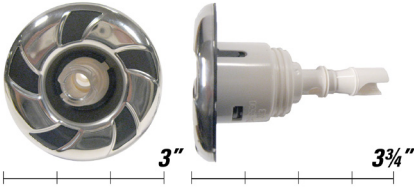

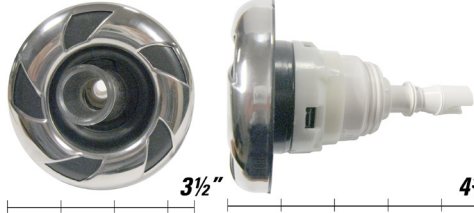
## Replacement Parts

Screw-in Jet Inserts	
Description	Used by
<b>ELE 2" Euro No Eyeball</b> PLUCS2295021S 	Patio Patio+ Inground Spas
<b>ED 2" Euro Directional</b> PLUCS2295051S 	Patio Patio+ Inground Spas
<b>MED 3" XL Cluster Storm Directional</b> PLUCS2295031S 	Patio Patio+ Inground Spas
<b>mfd 3" Micro Flow Directional</b> PLUCS2295061S 	Patio Patio+ Inground Spas

Screw-in Jet Inserts	
Description	Used by
<b>MFD 3.5" Maxi Flow Directional</b> PLUCS2295091S 	Patio Patio+ Inground Spas
<b>PSD 5" Power Storm</b> PLUCS2295131S 	Patio Patio+ Inground Spas
<b>ET 2" Cluster Storm Twin</b> PLUCS2295161S 	Patio Patio+ Inground Spas
<b>MMP 3" Mini Multi-Massage</b> PLUCS2295171S 	Patio Patio+ Inground Spas

**Note:** All Cal Spa models use a combination of screw-in and snap-in jet inserts where removable jets are used.

Please visit [www.quickspaparts.com](http://www.quickspaparts.com) to order your replacement parts.

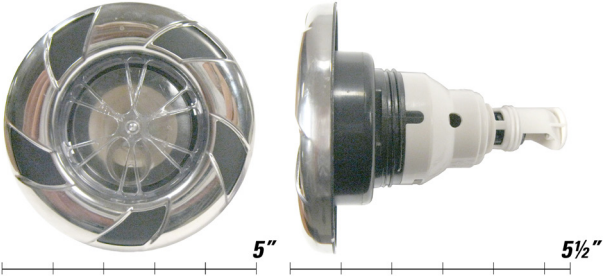
Screw-in Jet Inserts	
Description	Used by
<b>PSTR 5" Power Storm Twin Roto</b> PLUCS2295181S 	Patio Patio+ Inground Spas
<b>MMP 5" Power Storm Riffed</b> PLUCS2295141S 	Patio Patio+ Inground Spas
<b>PST 5" Power Storm Wagon Wheel</b> PLUCS2295191S 	Patio Patio+ Inground Spas

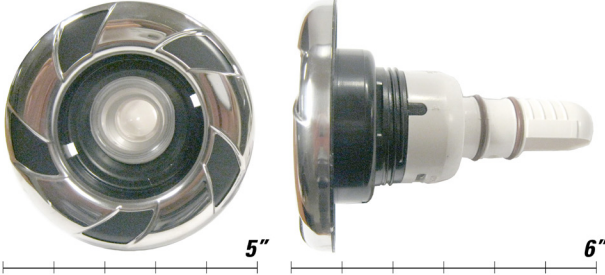
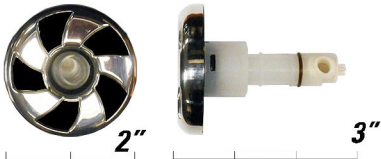
Screw-in Jet Inserts	
Description	Used by
<b>T 5" Tornado Adjustable</b> PLUCS2295201S 	Patio Patio+ Inground Spas
<b>2" Neck Jet Directional</b> PLU29923-014-000 	Patio Patio+ Inground Spas

If you need jet bodies, go to [www.quickspaparts.com](http://www.quickspaparts.com) or refer to the Cal Spa Replacement Parts Catalog, which can be downloaded from [www.calspas.com/replacementparts](http://www.calspas.com/replacementparts).



Please visit [www.quickspaparts.com](http://www.quickspaparts.com) to order your replacement parts.

Snap-in SQR Jet Inserts	
Description	Used by
<p><b>Velocity 5VTX Blue Jet</b>  <b>Symbol: 5VTX</b>  <b>Part #:</b> PLU29950-011-400  <b>Size: 5"D x 5.5"L</b></p> 	<p>Escape                      Escape+                      Platinum                      Platinum+</p>
<p><b>Velocity 5VTX LED Jet</b>  <b>Symbol: 5VTX</b>  <b>Part #:</b> PLU29950-011-100  <b>Size: 5"D x 5.5"L</b></p> 	<p>Escape                      Escape+                      Platinum                      Platinum+</p>

Snap-in SQR Jet Inserts	
Description	Used by
<p><b>Velocity Roto Blue Jet</b>  <b>Symbol: 5R</b>  <b>Part #:</b> PLU29950-081-400  <b>Size: 5"D x 5.5"L</b></p> 	<p>Escape                      Escape+                      Platinum                      Platinum+</p>
<p><b>Velocity Roto LED Jet</b>  <b>Symbol: 5R</b>  <b>Part #:</b> PLU29950-081-100  <b>Size: 5"D x 5.5"L</b></p> 	<p>Escape                      Escape+                      Platinum                      Platinum+</p>
<p><b>Velocity Directional Blue Jet</b>  <b>Symbol: 5D</b>  <b>Part #:</b> PLU29950-012-400  <b>Size: 5"D x 5.5"L</b></p> 	<p>Escape                      Escape+                      Platinum                      Platinum+</p>

Please visit [www.quickspaparts.com](http://www.quickspaparts.com) to order your replacement parts.



Snap-in SQR Jet Inserts	
Description	Used by
<p><b>Velocity Directional LED Jet</b>  <b>Symbol: 5D</b>  <b>Part #:</b> PLU29950-012-100  <b>Size: 5"D x 5.5"L</b></p> 	<p>Escape                      Escape+                      Platinum                      Platinum+</p>
<p><b>Velocity Massage-14 Blue Jet</b>  <b>Symbol: 5MM</b>  <b>Part #:</b> PLU29950-071-400  <b>Size: 5"D x 5.5"L</b></p> 	<p>Escape                      Escape+                      Platinum                      Platinum+</p>
<p><b>Velocity Massage-14 LED Jet</b>  <b>Symbol: 5MM</b>  <b>Part #:</b> PLU29950-071-100  <b>Size: 5"D x 5.5"L</b></p> 	<p>Escape                      Escape+                      Platinum                      Platinum+</p>

Snap-in SQR Jet Inserts	
Description	Used by
<p><b>Velocity Tornado/WP Blue Jet</b>  <b>Symbol: 5T</b>  <b>Part #:</b> PLU29950-501-400  <b>Size: 5"D x 5.5"L</b></p> 	<p>Escape                      Escape+                      Platinum                      Platinum+</p>
<p><b>Velocity Tornado/WP LED Jet</b>  <b>Symbol: 5T</b>  <b>Part #:</b> PLU29950-501-100  <b>Size: 5"D x 5.5"L</b></p> 	<p>Escape                      Escape+                      Platinum                      Platinum+</p>
<p><b>Velocity Double Roto Blue Jet</b>  <b>Symbol: 5DR</b>  <b>Part #:</b> PLU29950-032-400  <b>Size: 5"D x 5.5"L</b></p> 	<p>Escape                      Escape+                      Platinum                      Platinum+</p>

If you need jet bodies, go to [www.quickspaparts.com](http://www.quickspaparts.com) or refer to the Cal Spa Replacement Parts Catalog, which can be downloaded from [www.calspas.com/replacementparts](http://www.calspas.com/replacementparts).

Please visit [www.quickspaparts.com](http://www.quickspaparts.com) to order your replacement parts.

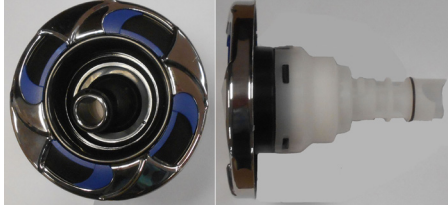
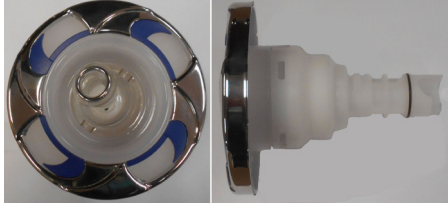
Snap-in SQR Jet Inserts	
Description	Used by
<p><b>Velocity Double Roto LED Jet</b>  <b>Symbol: 5DR</b>  <b>Part #:</b> PLU29950-032-100  <b>Size: 5"D x 5.5"L</b></p> 	<p>Escape            Escape+            Platinum            Platinum+</p>
<p><b>Velocity Directional Blue Jet</b>  <b>Symbol: 4D</b>  <b>Part #:</b> PLU29940-112-400  <b>Size: 4"D x 4.5"L</b></p> 	<p>Escape            Escape+            Platinum            Platinum+</p>
<p><b>Velocity Directional LED Jet</b>  <b>Symbol: 4D</b>  <b>Part #:</b> PLU29940-112-100  <b>Size: 4"D x 4.5"L</b></p> 	<p>Escape            Escape+            Platinum            Platinum+</p>



Snap-in SQR Jet Inserts	
Description	Used by
<p><b>Velocity Roto Blue Jet</b>  <b>Symbol: 4R</b>  <b>Part #:</b> PLU29940-122-400  <b>Size: 4"D x 4.5"L</b></p> 	<p>Escape            Escape+            Platinum            Platinum+</p>
<p><b>Velocity Roto LED Jet</b>  <b>Symbol: 4R</b>  <b>Part #:</b> PLU29940-122-100  <b>Size: 4"D x 4.5"L</b></p> 	<p>Escape            Escape+            Platinum            Platinum+</p>
<p><b>Velocity Double Roto Blue Jet</b>  <b>Symbol: 3DR</b>  <b>Part #:</b> PLU29930-191-400  <b>Size: 3"D x 3.25"L</b></p> 	<p>Escape            Escape+            Platinum            Platinum+</p>

If you need jet bodies, go to [www.quickspaparts.com](http://www.quickspaparts.com) or refer to the Cal Spa Replacement Parts Catalog, which can be downloaded from [www.calspas.com/replacementparts](http://www.calspas.com/replacementparts).





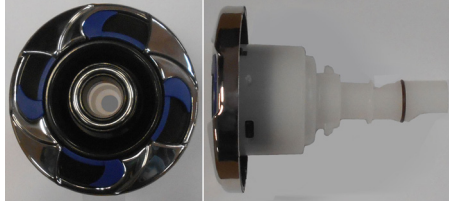

Please visit [www.quickspaparts.com](http://www.quickspaparts.com) to order your replacement parts.

Snap-in SQR Jet Inserts	
Description	Used by
<p><b>Velocity Double Roto LED Jet</b>  <b>Symbol: 3DR</b>  <b>Part #:</b> PLU29930-191-100  <b>Size: 3"D x 3.25"L</b></p> 	<p>Escape            Escape+            Platinum            Platinum+</p>
<p><b>Velocity Massage-7 Blue Jet</b>  <b>Symbol: 3M</b>  <b>Part #:</b> PLU29930-142-400  <b>Size: 3"D x 3.25"L</b></p> 	<p>Escape            Escape+            Platinum            Platinum+</p>
<p><b>Velocity Massage-7 LED Jet</b>  <b>Symbol: 3M</b>  <b>Part #:</b> PLU29930-142-100  <b>Size: 3"D x 3.25"L</b></p> 	<p>Escape            Escape+            Platinum            Platinum+</p>

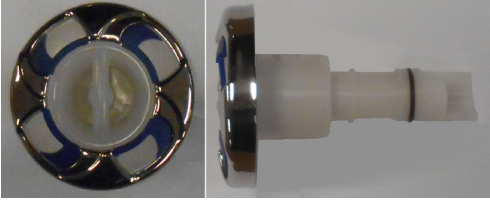
Snap-in SQR Jet Inserts	
Description	Used by
<p><b>Velocity Directional Blue Jet</b>  <b>Symbol: 3D</b>  <b>Part #:</b> PLU29930-112-400  <b>Size: 3"D x 3.25"L</b></p> 	<p>Escape            Escape+            Platinum            Platinum+</p>
<p><b>Velocity Directional LED Jet</b>  <b>Symbol: 3D</b>  <b>Part #:</b> PLU29930-112-100  <b>Size: 3"D x 3.25"L</b></p> 	<p>Escape            Escape+            Platinum            Platinum+</p>
<p><b>Velocity Roto Blue Jet</b>  <b>Symbol: 2R</b>  <b>Part #:</b> PLU29920-022-400  <b>Size: 2"D x 3"L</b></p> 	<p>Escape            Escape+            Platinum            Platinum+</p>

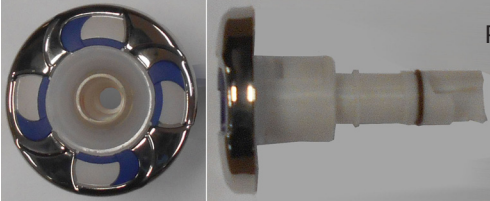
Please visit [www.quickspaparts.com](http://www.quickspaparts.com) to order your replacement parts.

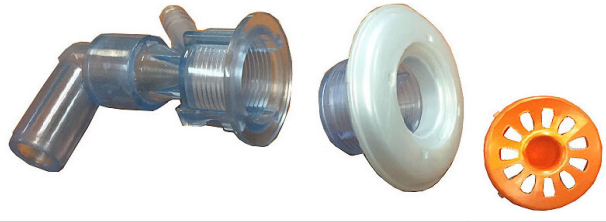
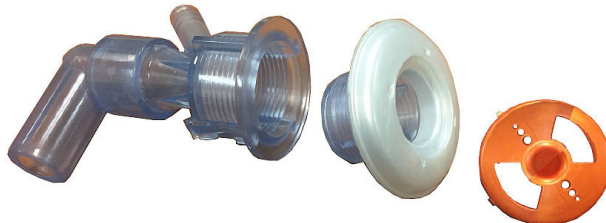
Snap-in SQR Jet Inserts	
Description	Used by
<p><b>Velocity Roto LED Jet</b>  <b>Symbol: 2R</b>  <b>Part #:</b> PLU29920-022-100  <b>Size: 2"D x 3"L</b></p> 	<p>Escape                      Escape+                      Platinum                      Platinum+</p>
<p><b>Velocity Directional Blue Jet</b>  <b>Symbol: 2D</b>  <b>Part #:</b> PLU29920-012-400  <b>Size: 2"D x 3"L</b></p> 	<p>Escape                      Escape+                      Platinum                      Platinum+</p>
<p><b>Velocity Directional LED Jet</b>  <b>Symbol: 2D</b>  <b>Part #:</b> PLU29920-012-100  <b>Size: 2"D x 3"L</b></p> 	<p>Escape                      Escape+                      Platinum                      Platinum+</p>

Snap-in SQR Jet Inserts	
Description	Used by
<b>Jets</b>	
<p><b>Flex Jet</b>                      PLU23512-311-700</p> 	
<p><b>Duo Jet</b>                      PLU23512-321-700</p> 	
<p><b>Precision Jet</b>                      PLU2312-331-700</p> 	
<p><b>Air X Therapy Ring</b>                      PLU23512-331-100</p> 	

If you need jet bodies, go to [www.quickspaparts.com](http://www.quickspaparts.com) or refer to the Cal Spa Replacement Parts Catalog, which can be downloaded from [www.calspas.com/replacementparts](http://www.calspas.com/replacementparts).

Please visit [www.quickspaparts.com](http://www.quickspaparts.com) to order your replacement parts.

### Velocity Diverter Valves

#### Velocity

**1" Blue Diverter Valve**

**Symbol: D1**

**Part #: PLU25056-202-400**

**Size: 2.5" x 5"L**



#### Velocity

**1" LED Diverter Valve**

**Symbol: D1**

**Part #: PLU25056-202-100**

**Size: 2.5" x 5"L**



#### Velocity Air Control Blue

**Symbol: A**

**Part #: PLU25059-202-400**

**Size: 3.125" x 5"L**

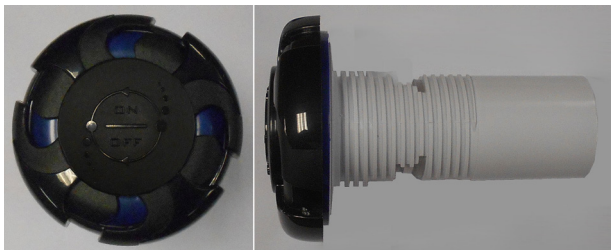

### Velocity Diverter Valves

#### Velocity Air Control LED

**Symbol: A**

**Part #: PLU25059-202-100**

**Size: 3.125" x 5"L**

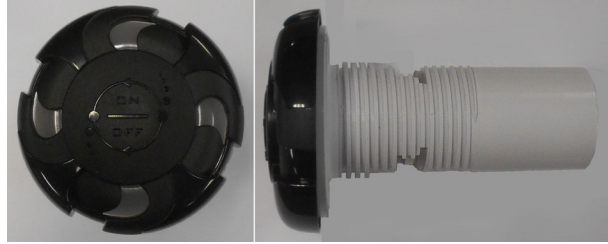

#### Velocity

**2" Diverter Valve Blue**

**Symbol: D2**

**Part #: PLU25058-202-400**

**Size: 4.5" x 7.75"L**

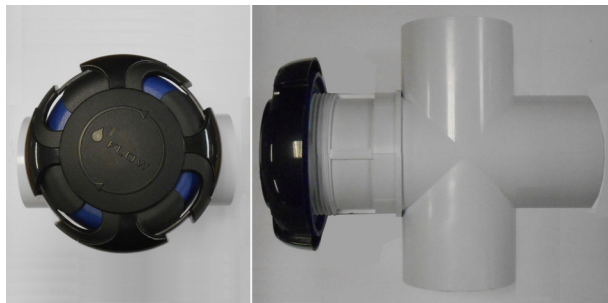

#### Velocity

**2" Diverter Valve LED**

**Symbol: D2**

**Part #: PLU25058-202-100**

**Size: 4.5" x 7.75"L**



Please visit [www.quickspaparts.com](http://www.quickspaparts.com) to order your replacement parts.

### Velocity Diverter Valves

**Velocity Underwater**

**2" Diverter Valve Blue**

**Symbol: D2**

**Part #:**

**Size:**

**Velocity Underwater**

**2" Diverter Valve LED**

**Symbol: D2**

**Part #:**

**Size:**

**Velocity**

**1" Diverter Valve Wall Fitting LED**

**Part #: PLU25030-089-200**

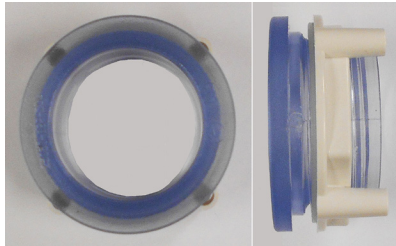

**Velocity**

**Air Control Wall Fitting LED**

**Part #: PLU25090-089-200**

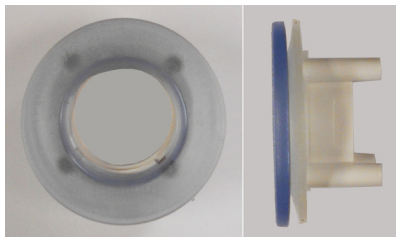

**Velocity**

**2" Diverter Valve Wall Fitting LED**

**Part #: PLU25048-089-200**

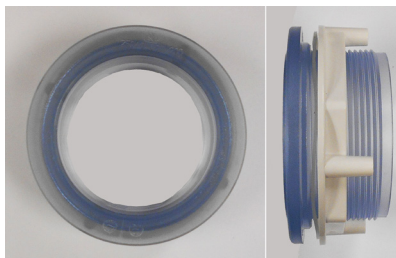

### Velocity Diverter Valves

**Velocity**

**Wall Fitting 2" Black (#25048-004-200)  
(for Diverter Valve)**

**Part #: PLU21701738**



**Velocity**

**Wall Fitting 1" Black (#25030-004-200)  
(for On-Off Valve)**

**Part #: PLU21701739**

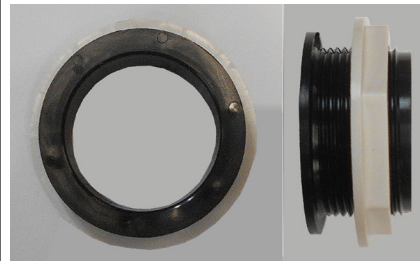

Please visit [www.quickspaparts.com](http://www.quickspaparts.com) to order your replacement parts.

### Water Diverter Valves

**Diverter Valve 2" Titanium Black (CS600303T1-TT)**

PLU21300465



**Diverter Valve 1" Titanium Black (CS600426T1-TT)**

PLU21300453



**Diverter Valve 1 1/2" On/Off ASSY (600-4601)**

PLU21100045



### Air Control Valve

**Air Control with Titanium Black CS660350T1-TT**

PLU21300504



**Aquatic Air Therapy (AAT) Air Control**

PLU25059-211-00



### Drains

**Drain Super Hi Flo Suction 2 1/2" Black (640-3581LGV)**

PLU21400146



**Low Profile Drain 3/4" Black (640-0511)**

PLU21400401



### Pillows

**Cascade Pillow No Insert Black**

ACC01401031

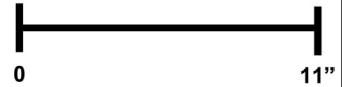

**Infinity Pillow Ribbed Black**

ACC01401051

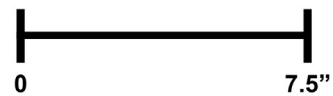

**Infinity Pillow Plain Black**

ACC01401061



**Y Pillow recess**

ACC01401101







### Cover Lock and Keys



ACC01800026

If you need jet bodies, go to [www.quickspaparts.com](http://www.quickspaparts.com) or refer to the Cal Spa Replacement Parts Catalog, which can be downloaded from [www.calspas.com/replacementparts](http://www.calspas.com/replacementparts).

Please visit [www.quickspaparts.com](http://www.quickspaparts.com) to order your replacement parts.

Filters	
50 sq ft	<p>FIL50-5D13H15FCT-3</p> 
75 sq ft	<p>FIL75-5D17H15FCT-3</p> 
75 sq ft Mega	<p>FIL75-7D155H2MCT-3</p> 
<p>DYNA FLO XTRA Lo-Pro 75 SQ. Ft.</p> <p>2" CV, 4 SCALLOP (less cartridge)</p>	<p>FIL11703305</p> 

Teleweir Skimmers	
<p>50 square foot teleweir skimmer:</p>	 
<p>Filter attaching cap assembly</p> <p>FIL11700013</p>	
<p>Filter skimmer inner pipe</p> <p>FIL11700012</p>	
<p>75 square foot teleweir mega skimmer:</p>	 
<p>Filter attaching cap assembly</p> <p>FIL11700025</p>	
<p>Filter skimmer inner pipe</p> <p>FIL11700026</p>	

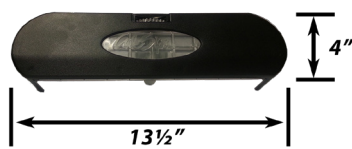
Waterfalls	
<p>Cascade II Waterfall Black textured with valve and logo 12 -3/8" '14</p>	
<p>PLU21800825TEX</p>	
<p>Cascade II Waterfall Curved Black Textured with Valve and Logo 12-3/8" '14</p>	
<p>PLU21800828</p>	

Please visit [www.quickspaparts.com](http://www.quickspaparts.com) to order your replacement parts.

### LED Lights

**1-LED light string**

LIT16100330

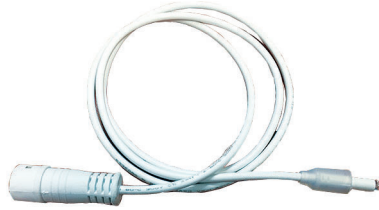

**2-LED light string**

LIT16100331

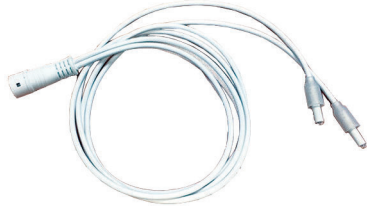

**4-LED light string**

LIT16100332

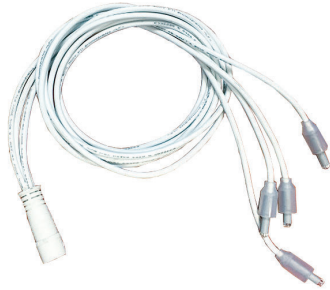

**1 to 3 ext. cord**

LIT16100335



**1 to 1 port ext. cord**

LIT16100338



**Interior light with logic (7 LED)**

LIT16100333



### LED Lights

**Interior light without logic (7 LED)**

LIT16100337

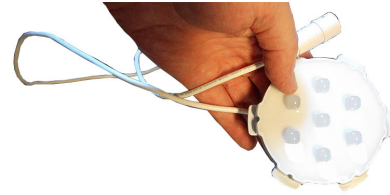

**Main light housing, LED lens, fitting nut**

LIT16100336

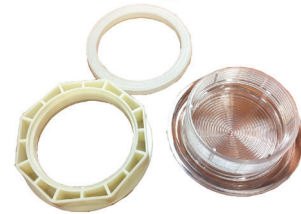

### Replacement Cabinet Panels

The complete selection of replacement cabinets for all models is very extensive and too lengthy for this owner's manual. To order replacement panels for your spa, visit [www.quickspaparts.com](http://www.quickspaparts.com).

Please visit [www.quickspaparts.com](http://www.quickspaparts.com) to order your replacement parts.

## Covers

All spa covers are designed with a tapered height, angling downward from the center to the sides to drive off rain and prevent water from pooling. The covers listed below are filled with either 1.5 lb or 2.0 lb foam.

### Standard

4" - 2.5"  
1.5 Lb. foam

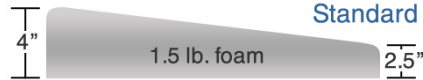

### Deluxe

5" - 3"  
2.0 Lb. foam

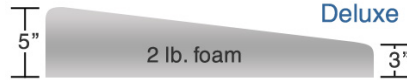

	Gray Standard	Slate Standard
<b>54" x 78"</b> Fits spa models: PZ-517L, PPZ-525L	COV5478S53G-CC-2	COV5478S53S-WN-2
<b>64" x 84"</b> Fits spa model: PPZ-537L	COV6484S53G-CC-2	COV6484S53S-WN-2
<b>72" x 72" triangle</b> Fits spa models: PZ-617T, PPZ-628T	COV7272TRS53G-CC-2	COV7272TRS53R-WW-2
<b>78" x 84"</b> Fits spa models: PZ-621L, PPZ-631L	COV7884S53G-CC-2	COV7884S53S-WN-2
<b>78" round</b> Fits spa model: P2511R	COV78RDS53G-CC-2	COV78RDS53S-WN-2
<b>87" x 87"</b> Fits spa model: EP-760DL, EC-754DL	COV8787S53G-CC-2	N/A

	Gray Standard	Gray Deluxe	Slate Standard	Slate Deluxe
<b>93" x 130"</b> Fits spa model: EC-947E	N/A	COV93130D53G-CC-2	N/A	N/A
<b>84" x 84" (7 foot spas)</b> Fits spa models: P2-722L, P2-722B, PP-732L+, PP-732B+, EC-735L, EC-735B, EC751L, EC751B, EP-761L, EP-761B, PL-760L, PL-760B, PPL7L+	COV8484S53G-CC-2	COV8484D53G-CC-2	COV8484S53S-WN-2	COV8484D53S-WN-2
<b>93" x 93" (8 foot spas)</b> Fits spa models: EC-835L, EG835B, EC-851L, EC-851B, EC-852L, EC-864L, EC-864B, EP-861L, EP-864B, PL-860L, PL-861B, PL-880L, PL-881B, PPL-8B+	COV9393S53G-CC-2	COV9393D53G-CC-2	COV9393D53S-WN-2	COV9393D53R-WW-2



## Basic Troubleshooting

The troubleshooting guidance provided here is intended to cover the most common problems a spa owner may encounter. For more in-depth troubleshooting, go to [www.calspas.com/troubleshooting](http://www.calspas.com/troubleshooting).

Symptom	Possible Solutions
---------	--------------------

### Problems starting up

Pump won't prime	See priming instructions on page 9.
Breaker keeps shutting off	Reset the GFCI breaker. If this continues, contact your dealer or a qualified spa technician.

### Power and system problems

System won't start up or breaker keeps shutting off	Power may be shut off. Turn on GFCI circuit breaker. If this continues, contact your dealer or a qualified spa technician.
Control panel doesn't respond	Turn on or reset the GFCI circuit breaker. If this does not solve the problem, contact your dealer or a qualified spa technician.  If you hear the pump running but the control panel doesn't respond, contact your dealer
Spa does not turn off	Spa may be trying to heat up. Check if spa is in Ready or Rest mode.  In cold climates, if spa is not equipped with full foam or any kind of insulation, it will try to maintain the set temperature. Set the spa to low temperature range and set the temperature to 80°F.  Spa may be in filter cycle. If it is, this is normal and no adjustment is necessary.
Message on the control panel	There may be a problem. See General Messages on page 61.

### Heat problems

Spa water does not get hot	Spa may be in low temperature range. Set the spa to high temperature range.  The filter may be dirty or may need to be replaced. Clean or replace the filter.  The water level may be too low. Fill the spa with water level at 4 to 6 inches from the top.  The temperature is not turned up high enough. Raise temperature on topside control.  Cover the spa. The cover will keep heat in the spa and help keep heat from escaping. Make sure cover is on at all times when spa is not in use.  The heater element may be old, deteriorated, coated with scale, or defective. Contact your dealer for more assistance.  The gate valves may be partially or completely closed. NEVER OPERATE YOUR SPA WITH THE GATE VALVES CLOSED!
----------------------------	---

Symptom	Possible Solutions
Spa overheats - temperature greater than 110°F / 43°C	<p>Overheating can occur during summer months and may not necessarily indicate a malfunction. When it occurs, a message code may also appear on the control panel.</p> <p>Temperature may be set too high. Turn the set temperature down to a lower temperature.</p> <p>Filtration time may be too long. Turn the filtration cycles down during the warm months.</p> <p>The spa may not be properly ventilated. Make sure the front of the spa is not blocked to allow air flow.</p> <p>High speed pumps may have been running too long. Limit pump running time to no more than 15 to 30 minutes.</p>

### Water pressure problems

Low water pressure	<p>Jet valves may be partially or fully closed. Open the jet valves.</p> <p>Filter cartridge may be dirty. Clean or replace the filter.</p> <p>Pump may have airlock. Remove airlock by priming spa (page 9)</p> <p>The suction fittings may be blocked. Remove any debris that may be blocking them.</p> <p>The filter skimmer may be blocked. Remove the blockage.</p> <p>Gate valves may be closed. Open gate valves. Note: Never operate your spa with the gate valves closed!</p> <p>Spa may be running in filtration mode. Press JETS or JETS 1 button to turn on high speed pump.</p>
No water pressure (no water stream from any jets)	<p>Power may be switched off. Turn the power back on.</p> <p>The pump may be defective. After you have tried all other troubleshooting, contact your dealer for assistance.</p>
Jets surge on and off	Water level may be too low. Add water to normal level.

### Pump problems

Pump runs constantly – will not shut off	There may be a problem with circuit board. Contact your dealer.
Noisy pump	<p>The water level may be too low. Fill the spa with water level at 4 to 6 inches from the top.</p> <p>Filter cartridge may be dirty. Clean or replace the filter.</p> <p>Pump may have airlock. Remove airlock by priming spa (page 9)</p> <p>The suction fittings may be blocked. Remove any debris that may be blocking the suction fittings.</p> <p>Gate valves may be closed. Open gate valves. Note: Never operate your spa with the gate valves closed!</p> <p>Air may be leaking into the suction line. Contact your dealer for assistance.</p> <p>Debris may be inside the pump. Contact your dealer for assistance.</p> <p>Noise may be a sign of damage. Contact your dealer for service.</p>

Symptom	Possible Solutions
Pump turns off during operation	Automatic timer may have completed its cycle. Press JETS or JETS 1 button to start the cycle again. Pump may have overheated due to the vents on the equipment door being blocked. Make sure the front of the spa is not blocked to allow air flow. The pump motor may be defective. Contact your dealer for assistance.
Pump has a burning smell while running	A burning smell may be a sign of damage. Contact your dealer for service.
Pump does not run	Pump may have over heated. Let it cool for an hour and try operating the spa for a shorter time. Power to the spa may be shut off. Turn on or reset the GFCI circuit breaker. If this does not solve the problem, contact your dealer or a qualified spa technician.

## “Thermal Creep”

Cal Spas are designed with energy-efficient components and systems that are meant to sustain heat generated by the equipment, which is then cycled back into the spa water. In hot weather or in situations where the spa is set to extended run times, Thermal Creep may occur. Thermal Creep is a condition where the measured water temperature can be higher than the set temperature. To manage Thermal Creep you may:

**Vent your cover.** This means placing a folded cloth about 3/4” (2cm) thick under all four corners of the cover before you lock the cover down.

**Open your cover.** Opening the cover at night will also quickly cool the water down if desired.

**Open all air controls.** Set your filtration cycles to run during the cooler times of the day or night.

**Reduce the length of your filter cycles.**

**Visit your local dealer for additional guidance.**

Since Thermal Creep only occurs in well-insulated hot tubs, it is not indicative of something that is wrong with your spa or its equipment.

# LIMITED WARRANTY

This Limited Warranty is extended to the original purchaser of a Cal Spa brand portable spa manufactured after January 1, 2019 and installed for residential use in the United States of America and Canada. This warranty begins on the date of delivery of the spa, but in no event later than one year from the date of manufacture.

This warranty applies only to these spa lines: →	Patio, Patio+ Veranda	Escape, Escape +	Special Edition
<b>Shell Structural</b> Warranted against water loss due to defects in the spa shell.	5 years	10 years	10 years
<b>Shell Finish</b> Warranted against blistering, cracking, or delaminating of the interior surface of the spa shell.	2 years	7 years	7 years
<b>Equipment and Controls</b> Electrical equipment components – specifically limited to the pumps, standard titanium heater, and control system – are warranted against malfunctions due to defects in workmanship or materials.	2 years	5 years	5 years
<b>Plumbing</b> Warranted against leaks due to defects in workmanship or materials.	2 years	5 years	5 years
<b>Cabinet - Synthetic or Fiberglass</b> Warranted against defects in workmanship or materials. Normal wear and weathering of the finish will occur naturally over time and are not defects.	1 year	5 years	5 years

## Warranties for Other Components

The fuses, headrests, cabinet finish, and filters are warranted to be free of defects in workmanship and material at the time of delivery. All stereo-related components (receiver, speakers, sub-woofer, stereo media locker, power supply, wireless remote control etc.) are warranted against malfunction due to defects in workmanship or material for one year from the original date of delivery. All other factory-installed components not mentioned specifically, including, but not limited to the wood frame, jets, diverter valves, LED lighting systems, filter lids, and mechanical components, are warranted against malfunction due to defects in workmanship and material for two years from the original date of delivery. The spa cover delivered with the spa is warranted for one year for Escape Plus and Veranda spas, 90 days for Patio, Patio Plus, Escape, and Special Edition spas.

## Genuine Cal Spas Parts & Accessories

This Limited Warranty is void if Cal Spas (the "Manufacturer") or its designated representative determines that the spa has been subjected to damage or failure due to installation of aftermarket parts that are not genuine Cal Spas branded parts and accessories. This disclaimer includes, but is not limited to filters, ozone systems, salt systems, repair parts and other accessories. Genuine Cal Spas brand parts and accessories are built to our highest standards of quality, durability and performance, and they are designed to work with your spa to ensure optimal performance and function.

## Performance

This warranty begins on the date of delivery of the spa, but in no event later than one year from the date of manufacture.

To obtain service in the event of a defect covered by this Limited Warranty, notify your Cal Spa dealer or Cal Spas as soon as possible and use all reasonable means to protect the spa from further damage. Upon proof of purchase, a designated service representative will correct the defect subject to the terms and conditions contained in this Limited Warranty. There will be no charge for parts or labor to repair the defect, although providing access to affect the repair is your responsibility as the spa owner. Freight charges for replacement parts is the responsibility of the spa owner. You may be assessed reasonable repairman travel mileage charges.

In the event that the spa is removed to a repair facility for repair and reinstalled, the cost of removal and reinstallation will be your responsibility as the spa owner. If the Manufacturer determines that repair of the covered defect is not feasible, it reserves the right to provide a replacement spa instead. In such an event, reasonable costs for removal of the original spa, shipping costs from the factory for the replacement spa and delivery and installation of the replacement will be your responsibility as the spa owner. The replacement spa will carry the balance of the original spa’s warranty. Spa covers are not included.

This warranty ends either by specified time frame, owner-transfer, relocation, or installation of any component other than by manufacturer.

**Warranty Limitations**

This Limited Warranty is void if Cal Spas or its designated representative determines that the spa has been subjected to alteration, neglect, misuse or abuse, or freight damage caused by the common carrier; any repairs have been attempted by anyone other than a designated representative; the failure is caused by accident, acts of God or other causes beyond the control of the Manufacturer; neglect, misuse and abuse include any installation, operation or maintenance of the spa other than in accordance with the instructions contained in the owner’s manual provided with the spa, including but not limited to the failure to maintain proper water chemistry and chemical balance and the use of abrasive or improper cleaners or non-genuine parts and accessories. This Limited Warranty does not provide coverage for any item attached to or installed on the spa after the date of manufacture or for gaining access to any component for repair or replacement. Spa units in commercial use are excluded from any coverage whatsoever. The spa owner accepts liability for repair work performed by anyone other than the Manufacturer or a designated Cal Spa representative. This Limited Warranty is void if damage occurs to the spa shell because of excessive heat buildup due to failure to cover a spa that is empty of water while exposed to direct sunlight.

**Limitations**

The Manufacturer disclaims all warranties, expressed or implied, in fact or in law, to the extent allowed by your State’s Law, including the warranty of merchantability and fitness for use, except as stated specifically herein. All warranty service must be performed by the Manufacturer or its designated representative using authorized Cal Spa parts. No agent, dealer, distributor, service company or other party is authorized to change, modify or extend the terms of this limited warranty in any manner whatsoever. The Manufacturer will not be responsible for any statements or representations made in any form that go beyond, are broader than, or are inconsistent with any authorized literature or specifications furnished by Cal Spas.

**Disclaimers**

The Manufacturer and its representatives shall not be liable for any injury, loss, cost or other damage, whether incidental or consequential, arising out of any defect covered by this limited warranty, including without limitation, loss of use of the spa and cost for removal of defective product even if the Manufacturer was advised of the possibility of damage. The liability of the Manufacturer under this limited warranty, if any, shall not exceed the original amount paid for the defective product. Coverage under this limited warranty shall commence as of the original date of delivery and the duration of such coverage shall not extend for any reason whatsoever beyond the stated time periods. These disclaimers shall be equally applicable to any service provided by the Manufacturer and its designated representatives.

**Legal Rights**

This Limited Warranty gives you specific legal rights. You may also have other rights that vary from state to state. Some states do not allow limitations on how long an implied warranty lasts, so this limitation may not apply to you.















## Warranty Registration

Registering your new Cal Spas product is quick and easy. It is important that you register your Cal Spas product as soon as possible. By taking just a few quick minutes to register, you can enjoy product alerts, more efficient support, and quicker service.

Go to [www.calspas.com/warranty](http://www.calspas.com/warranty). Fill in your information and click "Send Warranty Info"

**Locating the product serial number:** The serial number of your spa is located on a metal plate attached to the inside of the door for the equipment area. You will need this number to properly register your spa and activate coverage. Write this information in the space provided below.

Spa Model: \_\_\_\_\_

Spa Serial Number: \_\_\_\_\_

Date Purchased: \_\_\_\_\_

Date Installed: \_\_\_\_\_

Dealer's Phone Number: \_\_\_\_\_

Dealer's Address: \_\_\_\_\_

Please visit [www.quickspaparts.com](http://www.quickspaparts.com) to order your replacement parts.

LTR20191035, Rev. E  
7/5/19