

Cal Flame®

THE HOME RESORT EXPERIENCE







Award-Winning Hearth and Barbecue Manufacturer

Founded in 2000, Cal Flame is an award-winning hearth and barbecue manufacturer that offers innovative backyard solutions for every home and budget. The feature-rich Cal Flame lineup includes grills, grilling and drop-in accessories, customized outdoor kitchens, KD barbecue islands, custom barbecue carts, fireplaces and firepits. Best of all, Cal Flame offers you peace of mind knowing that all Cal Flame products are ETL and CE listed for your safety. With Cal Flame, your dream backyard is finally within reach!



Gourmet Grilling at its Finest

Only Cal Flame offers an extensive line of drop-in grills features a grill for every BBQ enthusiast and grilling preference, from porcelain to charcoal to convection. Like all Cal Flame products, Cal Flame drop-in grills are engineered using the latest technology and product innovations. Cal Flame's exclusive removable V-shaped grill grates have been designed to lock in the heat and prevent smaller food from falling through. Cal Flame grills also offer 25% more grilling capacity than other grill manufacturers and feature independent knobs with an exclusive patented design.



Entertain with a Wide Variety of Gourmet Barbecue Accessories

Turn an ordinary barbecue island into a state-of-the-art outdoor kitchen with Cal Flame barbecue accessories. Only Cal Flame offers all the gourmet necessities you need to build a true outdoor kitchen. With Cal Flame, you can accessorize your barbecue island or cart to create the outdoor kitchen solution of your dreams. Cal Flame eliminates the need to run inside during a backyard barbecue by providing the convenience of an indoor kitchen...without the walls.



State-of-the-Art Outdoor Kitchen

A Cal Flame outdoor kitchen is the perfect way to extend your living space and add value to your home. You can choose the barbecue island that's right for you from the widest selection in the industry -from 4 ft. to 10 ft. barbecue islands. With Cal Flame, you can customize your barbecue island with the gourmet grill and accessories of your choice. Complete the look of your island with your choice of granite, porcelain tile or natural stone tile countertops, and stucco or cultured stone base finishes -available in an array of elegant base designs. Choose from the widest range of barbecue island designs in various configurations to complement your personal Home Resort design, lifestyle and backyard landscape.



Barbecue Cart for Every Backyard

The A La Cart Series is the perfect solution for any grill master that is short on space but looking for a top-of-the-line A La Cart Plus and A La Cart Deluxe grill. This series allows you to select the cart size and storage space you need, along with any Cal Flame grill and standard single side burner. The carts feature two removable side/serving trays, a spice rack, bottle opener, towel and paper towel holders, two drawers, and a bottom compartment for a propane tank or additional storage.



Extend the Outdoor Season

Cal Flame outdoor fireplace and firepits are the perfect way to extend the outdoor season and seek warmth in the great outdoors. The innovative Cal Flame outdoor fireplaces and firepits feature all the latest technology and allow you to enjoy cool evenings while entertaining family and friends in your own private backyard retreat. A Cal Flame outdoor fireplace or firepit instantly adds a warm glow to your outdoor home resort, creating a calm, inviting ambiance. Cal Flame outdoor fireplaces and firepits can be customized to fit your personal taste and complement any backyard landscape. Designed with the finest material and craftsmanship, Cal Flame outdoor fireplaces and firepits are built to withstand all outdoor elements for years of enjoyment. Cal Flame outdoor fireplaces feature a 316-galvanized steel frame, sturdy one-piece construction, ETL approval and have a liquid propane/natural gas option.

A HISTORY OF AWARD WINNING EXCELLENCE

Over the years, Cal Flame has earned a reputation for producing quality bbq islands, bbq carts, bbq hardware, fireplaces and firepits that are at the forefront of innovation & design. Cal Flame is honored to have its home resort and bbq products so highly regarded by *Hearth & Home Magazine* - Honoring Innovation in Design and Technology for the Hearth, Patio and Barbecue Industry.

Cal Flame continues to be the leader in innovation and designs in all Cal Flame categories, creating the ultimate outdoor living experience.

Cal Flame also supports the local community by donating products to foundations like The Boys & Girls Club, Weingart Center Association and more. Cal Flame products can also be found in local and national publications and seen on popular national television shows!



BBQ Carts, A La Cart Deluxe

The A La Cart Deluxe comes with two drawers for storage, a bottom compartment for propane tank storage or additional space and includes the Bonus Accessory Package. It fits a Standard Single Flat Side Burner. All A La Cart barbecue carts require assembly.



A La Cart Deluxe
Includes Standard Single Flat Side Burner
Part Number: BBQ10445KDB
Shown with 5 Burner Convection Grill

Customize Your A La Cart
Select from any of our high-quality grills to complete your A La Cart Deluxe:



Removable Tray



A La Cart Deluxe Optional Single Flat Side Burner
Part Number: BB00852P

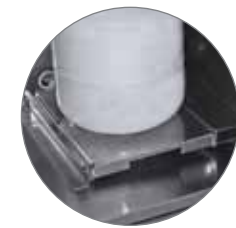

Pull-Out Propane Tray
Each A La Cart Plus and A La Cart Deluxe comes with a pull-out propane tank tray—the easy way to load your tank. Standard equipment on A La Cart Deluxe and A La Cart Plus:



Universal Grill Cover
The Universal Cart Cover features two adjustable straps which are easily adjusted to fit any Cal Flame Cart.

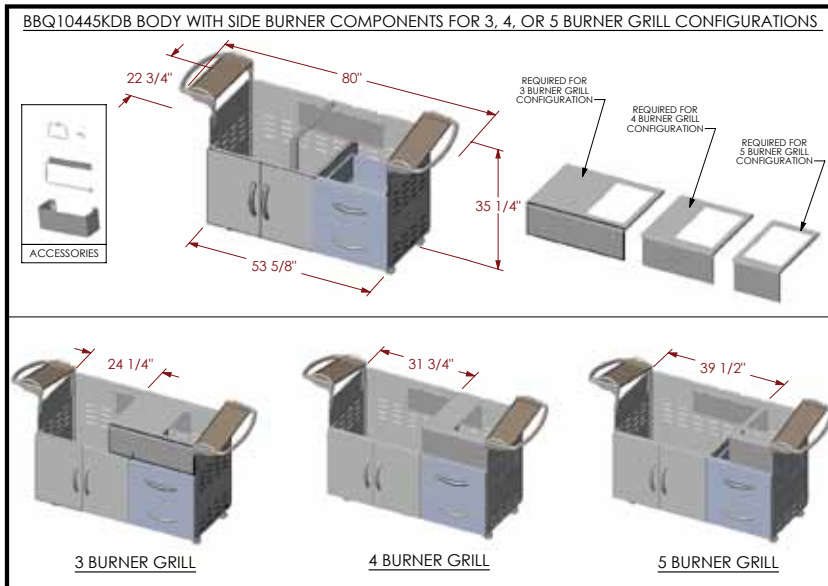

BBQ CARTS, A LA CART PLUS

Short on space, but want a pro-style grill fit for a gourmet chef? Get the Cal Flame grill that you want in a convenient mobile grill cart. The A La Cart Plus includes two side serving trays, a spice rack, bottle opener, towel and paper towel holders and storage beneath for a propane tank and more.



A La Cart Plus

Part Number: BBQ10345KDB
Shown with 4 Burner G4 Grill



Removable Tray



Customize Your A La Cart

Select from any of our high-quality grills to complete your **A La Cart Plus**:

BBQ09345KDB BODY COMPONENTS FOR 3, 4, OR 5 BURNER GRILL CONFIGURATIONS

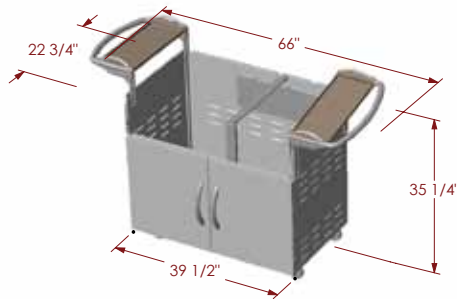
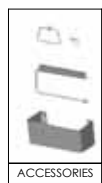

REQUIRED FOR
3 BURNER GRILL
CONFIGURATION

REQUIRED FOR
4 BURNER GRILL
CONFIGURATION

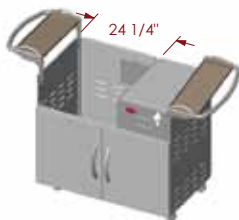

3 BURNER GRILL

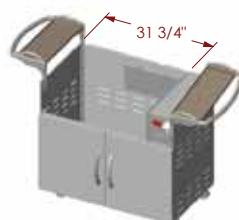

4 BURNER GRILL

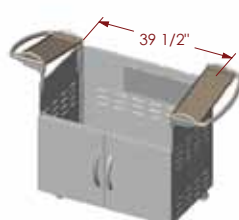

5 BURNER GRILL



Towel Racks

Each A La Cart Plus and A La Cart Deluxe comes with a pull-out propane tank tray—the easy way to load your tank. Standard equipment on A La Cart Deluxe and A La Cart Plus



Universal Grill Cover

The Universal Cart Cover features two adjustable straps which are easily adjusted to fit any Cal Flame Cart.



BBQ CARTS, A LA CART

The sturdy A La Cart accommodates the grill of your dreams—from the diminutive 3 Burner G3 Grill to the elite 5 Burner Convection Grill. All A La Cart barbecue carts require assembly.



A La Cart

Part Number: BBQ10245KDB
Shown with 3 Burner G3 Grill

Customize Your A La Cart

Select from any of our high-quality grills to complete your **A La Cart**:

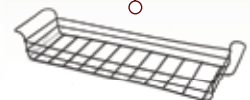

Optional Basket

Add a basket to your A La Cart for extra storage area, fit up to three baskets depending on the size of your A La Cart.
23" x 5-7/8" x 3"
Part Number: BBQ10000330



Universal Grill Cover

The Universal Cart Cover features two adjustable straps which are easily adjusted to fit any Cal Flame Cart.

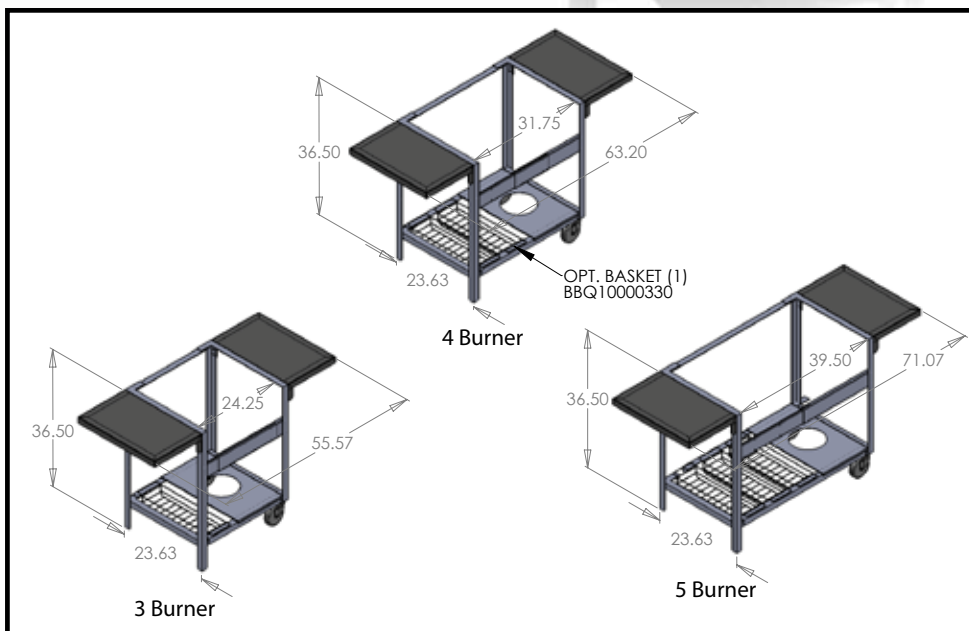

BARBECUE GRILLS

If you're passionate about outdoor entertaining, you will find just what you need amongst our collection of beautifully designed grills. Whether you integrate your barbecue grill with a Cal Flame BBQ Island or with a Cal Flame BBQ Cart, you can expect to grill with power and the precise control.



1 Sturdy Construction

Seamless 16-gauge 304 stainless steel doubled-wall hood with built-in temperature gauge for precision grilling.

2 Temperature Gauge

Precision cooking begins with just the right temperature. Extended prong for accurate cooking.

3 Durable Handle

Welded one-piece handle finished in high-polish.

4 Convenient Nighttime Grilling

Dual Halogen lights illuminates food for night time grilling.

5 New Warmer Rack Hideaway Hook

The warming rack suspends from convenient hooks when you need more rotisserie space.

6 12V Rotisserie Motor

The stainless steel motor creates smooth, continuous turning of the rotisserie for more even cooking.

7 Rotisserie Cooking

The infrared backburner produces an intense heat, evenly cooking up to 35 lbs. on the rotisserie spit.

8 Reversible Rotisserie Hook-Up

Rotisserie can be hooked directly to the grill, on either side, for its power source. With this unit attached to your Cal Flame grill you can turn a roast perfectly and guarantee you flawlessly cooked dishes.

9 Exclusive Convection Grill

Unique technology offered only on Cal Flame grills features a powerful fan that circulates heat throughout the cooking area, using 30% less fuel and cooking 30% faster and eliminating cold zones and the need to shift food.

10 Smart Grilling

Cal Flame exclusive V-shaped grates have double the stainless steel holding twice the heat of standard cooking grid.

11 Largest Grilling Surface Areas

Cal Flame offers 25% more grilling capacity than the competition.

12 Cast Stainless Steel Burners

These commercial-grade burners emit 15000 BTUs each and features an individual ignitor per burner.

13 Clean Knobs Every Time

Front panel controls are always protected by the one-piece splash guard.

14 One Hand Operation Knob

Cal Flame exclusive custom knobs feature one-hand operation with individual ignitor per burner.

15 Easy Cleaning

The full-width drip tray catches all drippings and slides out for easy cleaning.

16 Conversion Kit

Cal Flame convection grills are built for liquid propane, but come with natural gas conversion kits as standard.

OPTIONAL FEATURES

View the complete line of optional features on pages 10-11. Customize your grill to fit your every need.

All Cal Flame grills are



and CE certified.





BBQ GRILLS **TOP GUN™ 5 BURNER CONVECTION**

The innovative Top Gun™ 5 Burner Convection Grill has been designed to fit any Cal Flame barbecue cart or island! It features five cast stainless steel burners and a powerful centrifugal fan that uniformly circulates heat throughout the grilling area. It also features a glass window on the hood for your grilling convenience and a striking new light feature on each stainless steel knob - a Cal Flame exclusive!

Features

- **New Stainless Steel Knobs with Innovative Light Design - a Cal Flame Exclusive!**
- **Convenient Glass Window on hood**
- **Exclusive** Handle Design
- Five (5) 15,000 BTU high powered burners; 75,000 BTU overall
- 1,000 sq. in. cooking surface with 97,000 BTU overall
- Infrared 22,000 BTU back burner
- **Exclusive** 12V full-size convection fan circulates heat evenly
- Independent ignition on all burners
- Built-in smoker tray with dedicated burner
- Lip guards on all burners to prevent clogging
- Any burner can be switched with Sear Zone or Smoke Tray
- **Exclusive** Knobs with LED Lighting - Patented Design!
- Front splash guard with vent keeps grease away from knobs
- Full-sized rotisseries holds up to 35 lbs. (or two chickens)
- Rotisserie motor mounts on left or right side
- Flavor bar seals in juices
- 5 heavy duty exclusive V-grates are removable
- Full width warming rack with two positions
- Convenient lights to cook day or night with ease
- Full width drip tray
- Liquid Propane (LP) or Natural Gas (NG) igniter system

Dimensions

• 39" x 24" x 22"

Cut-Out Dimensions

• 38-3/8" x 22" x 9-1/4"

Exclusive glass window on the hood



Exclusive Handle Design



Exclusive Knobs with Custom Multi-Color LED Lighting - Patented Design!





BBQ GRILLS P4™ 4 BURNER DROP-IN GRILL

The Cal Flame P4 4-Burner Built In Gas Grill is the perfect pro-style grill for your outdoor environment. This Cal Flame 32-inch Grill is constructed with 304 stainless steel which features four 60,000 BTU, cast stainless steel burners each with a reliable easy-start ignition system for easy start-up. This grill allows any burner to be switched out with an optional Sear Zone burner or Smoke Tray for enhanced grilling alternatives.

Features

- Four (4) 15,000 BTU High powered cast Stainless Steel burners
- 60,000 BTU
- Rotisserie Burner 15,000 BTU
- 800 sq. in. cooking surface with a total of 75,000 BTUs
- Independent ignition on all burners
- Lip guards on all burners to prevent clogging
- Any burner can be switched with Sear Zone
- **Exclusive** heavy duty Cal Flame knobs
- Easy-start ignition every time
- Front splash guard with vent keeps grease away from knobs
- 4 heavy duty exclusive V-grates are removable, dishwasher safe
- Full width warming rack with two positions
- Thermometer lets you monitor the temperature at all times
- Rotisserie motor mounts on left or right side
- Full width drip tray
- Convenient lights to cook day or night with ease with easy on/off switch
- Liquid Propane (LP)

Dimensions

- 31 3/4" x 24" x 22 7/16"

Cut-Out Dimensions

- 30 7/8" x 22 1/4" x 9 1/2"



P-Griddle Tray

Enjoy fried favorites like eggs or bacon with this griddle tray. This tray comes with its own storage and blends perfectly with your island or cart.



P-Smoke Tray

Infuse your Cal Flame grill with the smoky flavor everyone loves with this convenient smoke tray that fits any Cal Flame grill!

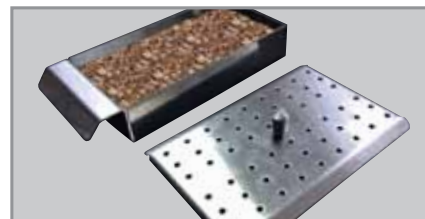

P-Grill Cover

The Grill Cover fits the 4-burner Cal Flame grill.



BBQ Drop-In Grill Series

All Cal Flame grills series are ETL and CE listed and constructed using 304 or 430 Commercial Grade stainless steel, double-walled construction, and cast stainless steel or porcelain burners. Standard premium features include 3-5 burners; individual blowtorch igniters for each burner, infrared back burner, nighttime grill lights, full-length drip tray, and flavor bars. Cal Flame Grills are the hottest looking grills on the market, and the best performing. With designer knobs, exclusive V-shaped grates and polished stainless steel construction, looks alone can sear your steak.

All Cal Flame grills are  and  certified.



BBQ Grill **Top Gun Convection** 5 Burner

Part Number: BBQ11875CTG



BBQ Grill **P Series P4**

Part Number: BBQ13P04



BBQ Grill **G Series** 5 Burner

Part Number: BBQ09G05



BBQ Grill **G Series** 4 Burner

Part Number: BBQ08G04



Grill

You don't need to be gourmet chef to prepare the finest barbecue cuisine. Our easy-to-use grill is perfect for grilling all of your barbecue favorites!



Exclusive Convection Oven

Our grills feature exclusive cast stainless steel burners and a powerful fan that cooks food evenly and quickly.



Rotisserie Burner

Enjoy the full-bodied taste of rotisserie cooking with rotisseries that can be mounted in left or right configurations!



Smoke Tray

Infuse your Cal Flame grill with the smoky flavor everyone loves with this convenient smoke tray that fits any Cal Flame grill!



Sear Zone

Lock in the juice by searing your barbecue favorites with this high-heat sear zone that fits perfectly on your Cal Flame grill.



Warming Rack

Keep food warm and away from direct heat with our convenient warming rack. When the rotisserie is in use, this rack can be stored using convenient storage hooks.





BBQ Grill Convection 5 Burner
Part Number: BBQ08875CP



BBQ Grill Convection 4 Burner
Part Number: BBQ08874CP

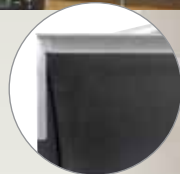

Heavy Duty Stainless Steel
protects & preserves your grill



Warming Rack with Hooks
hinges to make room for larger items



BBQ Grill G Series 3 Burner
Part Number: BBQ09G03



BBQ Grill G Series Charcoal
Part Number: BBQ09G870



Hood Thermometer
ensures the perfect temperature under the hood every time

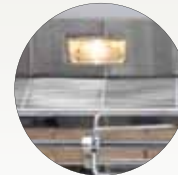

Grill Lighting
lets you cook with ease all day or night
NOT AVAILABLE ON G-SERIES



Rotisserie with 12V Motor
mounts to left or right of the grill
NOT AVAILABLE ON G-SERIES



Exclusive V-Grates
keep small foods from slipping below the cook top



Convection Grilling
Circulates hot air under the hood and spreads heat evenly
NOT AVAILABLE ON G-SERIES

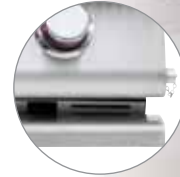

Full-Width Drip Tray
makes clean-up easy and hassle-free



Griddle Tray
Enjoy fried favorites like eggs or bacon with this griddle tray. This tray comes with its own storage and blends perfectly with your island or cart.



Pizza Brick Tray
Give you favorite pizza that brick oven flavor with this pizza brick tray. Keep the kids satisfied at every birthday party!



Deep Fryer Helper
Turn part of your grill into a deep frying station with this deep fryer helper. You'll love preparing tasty fries!



Charcoal Helper
Turn part of your Cal Flame grill into a charcoal & gas grill. Load removable tray with charcoal of your choice.



Universal Grill Cover
The Universal Grill Cover features two adjustable straps which are easily adjusted to fit any Cal Flame grill.



Barbecue Grill Accessories

Since the discovery of fire, people have enjoyed outdoor cooking. Since then, outdoor enthusiasts have sought more convenient, powerful and professional barbecue grills and accessories. Now you can do it with style and function! Cal Flame is the first and only manufacturer to offer you the commercial-grade equipment to build a true outdoor kitchen. The very best in stainless steel grills and cooking peripherals can now be yours. Side burners, food warmers and outdoor refrigerators eliminate the need to run inside and keep you where you want to be the most: At the grill! Cal Flame gives you the choice of grill accessories to personalize your barbecue island with your unique style of cooking. Our grills provide every convenience of an indoor kitchen—without the walls. Cal Flame: Gourmet grilling of the highest degree.

CUSTOMIZE YOUR GRILL

ROAST



Rotisserie Burners & Motor

Part Numbers: BBQ08856P3-4-5 (3, 4 or 5 Burner); BBQ07100781 (Motor)
Enjoy the full bodied taste of rotisserie cooking with rotisseries that can be mounted in left or right configurations!

Dimensions: 32-1/2"W for 3 Burner
40"W for 4 Burner
47-1/2"W for 5 Burner
5"x 4-1/4"W x 2-3/4"H for Motor

DEEP FRY

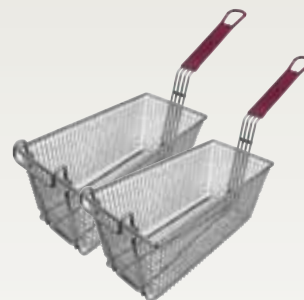
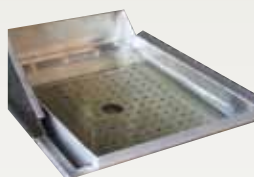

Deep Fryer Accessories Helper Set

Part Number: BBQ09902
Turn part of your grill into a deep frying station with this deep fryer helper. You'll love preparing tasty fries!

Dimensions: 14-1/2"W x 4"H x 19-1/4"D

ROAST



Rotisserie Basket

Part Number: BBQ08892
Perfect for roasting vegetables or cooking fish, this rotisserie basket makes preparing these foods and others easy!

Dimensions: 17"W x 6-1/2"D x 1-1/2"H

BAKE



Pizza Brick Tray

Part Number: BBQ07900
Give your pizza that brick oven flavor with this pizza brick tray. Keep the kids satisfied at every BBQ party!

Dimensions: 20 1/4"W x 1 1/2"H x 15 1/8"D





SEAR



Sear Zone Burner

Part Number: BBQ07890P

Lock in the juice by searing your BBQ with this high-heat sear zone that replaces one of the grill burners.

Dimensions: 5-3/8"W x 3-5/16"H x 12-1/2"D

SMOKE



Smoke Tray

Part Number: BBQ08854P

Infuse your outdoor BBQ with smoky flavor everyone loves with this convenient smoke tray that fits in your grill!

Dimensions: 5-1/4"W x 2-1/2"H x 17-1/8"D

GRIDDLE



Griddle Tray w/ Storage

Part Number: BBQ07862P

Enjoy fried foods like eggs with this griddle tray that comes with its own storage that blends with your island!

Dimensions: 15-3/8"W x 19-3/4"D x 4-1/2"H
Cut Out Dimen: 13-1/2"W x 19-5/8"D x 2-3/4"H

CHARCOAL

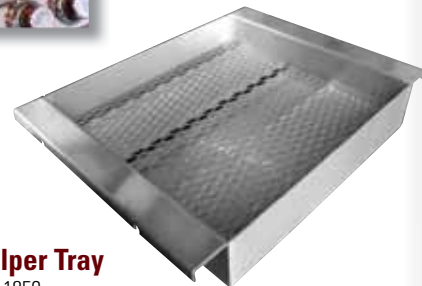

Charcoal Helper Tray

Part Number: BBQ11859

Turn part of your Cal Flame grill into a charcoal & gas grill. Load removable tray with charcoal of your choice.

Dimensions: 13-5/8"W x 17-5/8"D x 3"H



Barbecue Island Accessories

Convenient side burners make it easy to prepare multiple meals while you grill. Cook soups, stews and skillet dishes without having to run inside. Choose single and double side burners in the style that complements your backyard design. Drop-in accessories give you the functionality you need to handle any event in your backyard or garden. Keep side dishes fresh with food warmers and make any drink with cocktail centers, blenders and ice chests. Prepare rare meals with a vertical grill, hibachi grill and deep fryer. At Cal Flame, it's all about choice.

SIDE BURNERS



Deluxe Double Side By Side Burner

Part Number: BBQ08954P

The deluxe double side-by-side burner is designed to fit snugly in the island while protecting the counter space.

Dimensions:
26"W x 14"D x 10-1/2" H
Cut Out Dimensions:
25"W x 13-3/8"D x 7-1/4"H



Standard Side By Side Flat Burner

Part Number: BBQ08953P

The standard side-by-side burner is perfect for preparing tasty side dishes like soups, sauces or finger foods.

Dimensions:
28"W x 20-3/4"D x 6-5/8"H
Cut Out Dimensions:
26-5/8"W x 19-3/4"D x 4"H



Deluxe Double Side Burner

Part Number: BBQ08899P

Maximize your counter space while preparing delicious barbecue complements with the deluxe double side burner.

Dimensions:
13"W x 23"D x 10-1/8"H
Cut Out Dimensions:
12-1/8"W x 22"D x 7-1/4"H



Standard Single Flat Side Burner

Part Number: BBQ08852P

When you need another heat source for cooking, the standard single flat side burner is an excellent solution!

Dimensions:
12-1/2"W x 20-3/8"D x 5-1/2"H
Cut Out Dimensions:
11-1/4"W x 17-5/8"D x 3-5/8"H

DROP-IN ACCESSORIES



Hibachi Drop-In Grill

Part Number: BBQ10900P

Fried foods are easy with the hibachi drop-in grill. You'll be enjoying eggs, pancakes and stir-fry in no time!

Dimensions:
24"W x 24-3/4"D x 11-1/2"H
Cut Out Dimensions:
23-1/4"W x 22-1/4"D x 9-1/2"H



Power Burner Drop-In Grill

Part Number: BBQ10955P

Need a meal cooked fast or are you preparing something large? The power burner drop-in grill is your solution!

Dimensions:
19"W x 22-5/8"D x 12-1/2"H
Cut Out Dimensions:
18"W x 20-3/8"D x 9-1/4"H



12" Drop-In Food Warmer

Part Number: BBQ7888P

Turn your outdoor kitchen into the ultimate buffet with this 12" drop-in food warmer with three useful compartments!

Dimensions:
13-1/4"W x 25-1/4"D x 8-1/2"H
Cut Out Dimensions:
12-1/4"W x 21-1/2"D x 7"H



12" Cocktail Center

Part Number: BBQ07842P-12

Keep ice in a convenient place with the 12" cocktail center which comes with a towel rack and bottle opener.

Dimensions:
13"W x 24"D x 7"H
Cut Out Dimensions:
12"W x 22-1/4"D x 7"H





DROP-IN ACCESSORIES



18" Cocktail Center

Part Number: BBQ11842P-18

Keep drinks refreshed with the 18" cocktail center which conveniently holds ice, condiments and ice scoops.

Dimensions:

18"W x 25-3/4"D x 9-3/4"H

Cut Out Dimensions:

17-1/4"W x 24-1/4"D x 10"H



30" Drop-In Bar Center

Part Number: BBQ07902

Turn your island into a bar with this 30" cocktail center, which holds ice and condiments and features a sink!

Dimensions:

30"W x 22-1/4"D x 10-3/8"H

Cut Out Dimensions:

29-1/4"W x 22-1/2"D x 10-1/2"H

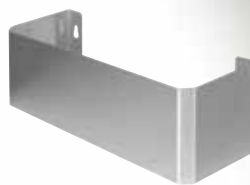

12" or 15" Spice/Juice Rack

12" Part Number: BBQ07846P-18

15" Part Number: BBQ07846P-30

Keep all of your juices and spices handy while you grill with this convenient spice/ juice rack! Own it today!

Dimensions:

12-1/2"W x 5"D x 5"H

15"W x 4-3/4"D x 4-3/4"H



Drop-In Ice Bucket

Part Number: BBQ11864

Convenient way to store ice for all your backyard festivities. Comes with 20.82" x 14.20" lid and drain.

Dimensions:

17"W x 23-3/4"D x 14-1/4"H

Cut Out Dimensions:

21"W x 24"D x 14-1/2"H



Stainless Steel Sink w/ Faucet & Soap Dispenser

Part Number: BBQ11963

Keep your hands and utensils clean with this stainless steel sink with cold water and soap dispenser.

Dimensions:

15"W x 15"D x 6-1/4"H

Cut Out Dimensions:

14-1/4"W x 14-1/4"D x 7"H



Barbecue Island Accessories

Doors & Drawers have everything you need to grill the perfect steak close at hand with deep drawers and spacious storage. Cal Flame provides several options for storing spices, cooking utensils, propane, aprons and everything else you may need.

DOORS & DRAWERS



18" Vertical Door

Part Number: BBQ09841P-18

This durable 18" stainless steel vertical door will keep all your BBQ gadgets and necessities hidden.

Dimensions:

18"W x 20"H

Cut Out Dimensions:

15-1/2"W x 17-1/2"H



27" Horizontal Door

Part Number: BBQ07841P-27

This beautiful 27" horizontal door is perfect for islands that won't accommodate double doors.

Dimensions:

27"W x 20"H

Cut Out Dimensions:

24-1/2"W x 17-1/2"H



18" Single Access Door

Part Number: BBQ10839P-18

This heavy-duty 18" door is constructed from stainless steel and is perfect for most islands!

Dimensions:

17-3/4"W x 20-3/4"H x 1-1/4"D

Cut Out Dimensions:

16-1/2"W x 19-1/2"H



30" Double Access Door

Part Number: BBQ10839P-30

These durable 30" double doors are perfect for when you need to store large items inside your BBQ island!

Dimensions:

30"W x 20-3/4"H x 2"D

Cut Out Dimensions:

28-1/2"W x 19-1/4"H



Towel Holder Rack

Part Number: BBQ08000500

For the ultimate in convenience add this towel holder rack to your 18" or 30" access doors. Add one or more!

Dimensions:

11-3/4"W x 4-3/4"H



18" Door & Drawer Combo

Part Number: BBQ11840P-18

This 18" door and drawer combo lets you to keep your barbecue tools protected from the elements. Add it today!

Dimensions:

18"W x 20-3/4"D x 20-3/4"H

Cut Out Dimensions:

17-1/8"W x 15-3/8"D x 20-1/4"H



30" Door & Drawer Combo

Part Number: BBQ11840P-30

This 30" combo incorporates two internal pull-out drawers and pull-out propane tray in a sealed enclosure.

Dimensions:

30" x 20-5/8" x 22"

Cut Out Dimensions:

29-1/4" x 19-1/4" x 20-1/2"



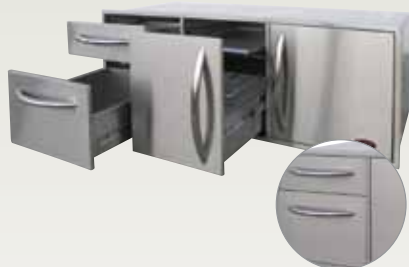

Complete Utility Storage Set

Part Number: BBQ07909

This complete utility storage set separates your food and features a tray to keep your propane or waste basket on.

Dimensions:
52-1/2"W x 20-3/4"D x 20-3/4"H
Cut Out Dimensions:
51-1/2"W x 19-1/2"D x 20-3/8"H



2 Drawer Horizontal

Part Number: BBQ11867P

Keep your important grilling tools, like spatulas, tongs and brushes close by with this 2 drawer horizontal accessory.

Dimensions:
39-1/4"W x 20-1/2"D x 10"H
Cut Out Dimensions:
37-3/4"W x 8-1/2"H



2 Drawer Storage Deep Drawer

Part Number: BBQ07868P

You'll enjoy this 2 drawer storage set which offers deep dimensions for oversized grilling tools like tongs and forks.

Dimensions:
13-1/8"W x 20-1/2"D x 20-3/4"H
Cut Out Dimensions:
10-1/2"W x 19-3/4"D x 17-3/8"H



3 Drawer Storage Wide

Part Number: BBQ08866

You can never have enough outdoor cooking storage. This 3 drawer storage accessory offers wide dimensions.

Dimensions:
18"W x 20-1/2"D x 20-3/4"H
Cut Out Dimensions:
15-1/4"W x 20-1/4"D x 17-1/4"H



Paper Towel Storage Door

Part Number: BBQ07910

Spills and splatters are never an issue when you have paper towels close by with this paper towel storage door!

Dimensions:
10-1/2"W x 6-1/4"D x 16-1/2"H
Cut Out Dimensions:
8-1/2"W x 14-1/4"H



Propane Tank Drawer

Part Number: BBQ07857P

Store your BBQ grill fuel in an elegant way with this convenient propane tank drawer that features a slide-out tray!

Dimensions:
16-5/8"W x 16-5/16"D x 22-5/8"H
Cut Out Dimensions:
14-3/4"W x 16-1/2"D x 20-1/4"H

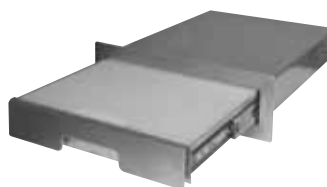

Pull Out Cutting Board

Part Number: BBQ07891P

Every outdoor chef needs a place for cutting food. This pullout cutting board is perfect for all your cooking needs.

Dimensions:
15-3/8"W x 19-1/2"D x 4-1/2"H
Cut Out Dimensions:
13-1/2"W x 19-5/8"D x 2-7/8"H



Bottle Opener and Catcher

Part Number: BBQ07901

Open up a cold one easily with one hand thanks to this bottle opener that comes with a cap catcher!

Dimensions:
3-1/2"W x 2-1/2"D x 3-3/4"H



Barbecue Island Accessories

Enjoy the convenience of a food warmer that discreetly hides itself in a drawer. Kids will love the electric pizza oven drawer that can also double as a dish warmer for keeping meals hot. Keep food fresh and ready for cooking or chill drinks with stainless steel refrigerators. Host keg parties in style with a built-in beer tap. Have sodas ready for the kids in the elegant beverage cooler. The Cal Flame ice maker ensures you never have to run to the store for more ice!

OVEN & REFRIGERATORS



2-in-1 Oven–Warmer and Pizza Oven (110V)

Part Number: BBQ10967E

Whether you're baking a pizza or want to keep a plate of food warm, this 2-in-1 oven-warmer is the ideal solution!

Dimensions:

30"W x 21-1/4"D x 11-1/2"H

Cut Out Dimensions:

28-3/4"W x 20-1/4"D x 10"H



Stainless Steel Refrigerator

Part Number: BBQ09849P

The stainless steel refrigerator is perfect for keeping your beverages cold and your food fresh at all times.

Dimensions:

20-3/8"W x 21-1/2"D x 31-3/8"H

Cut Out Dimensions:

21"W x 32-1/4"H



Beer Tap Refrigerator

Part Number: BBQ09843B

Impress your friends on game-day with this built-in beer tap refrigerator that will accommodate your keg.

Dimensions:

21-3/8"W x 25-3/8"D x 32-3/8"H

Cut Out Dimensions:

22"W x 34"H

PORTABLE "SOUND OF MUSIC"



Portable "Sound of Music" Audio Panel with Marine Grade iPod Stereo System

Part Number: BBQ12001

- 24" x 4 1/4" x 9" Stainless Steel Audio Panel – can be mounted to any surface, such as any BBQ Island, indoor/outdoor wall or inside a gazebo!
- Marine-Grade Stereo System with built-in iPod controls that conveniently charge and operate your iPod or iPhone, and two (2) 4-inch speakers
- iPod dock transmits RF audio to a high-output, high-range speaker system
- 72-watt weatherproof speakers
- Large IC-FM Tuner with improved reception
- Additional auxiliary port for other MP3 systems
- State-of-the-art remote control with: Balance and fader. Blue backlight display – displays FM station and iPod song titles, Preset FM stations





Outdoor Stainless Steel Refrigerator

Part Number: BBQ10710

Built to withstand the elements, the outdoor stainless steel refrigerator keeps your food fresh in any kind of weather!

Dimensions:

14-3/4"W x 23"D x 33"H

Cut Out Dimensions:

15-1/4"W x 24"D x 34"H



Outdoor Stainless Steel Ice Maker

Part Number: BBQ10700

You'll never have to leave the party to get ice with the outdoor rated ice maker. Add this accessory now!

Dimensions:

14-3/4"W x 24"D x 33"H

Cut Out Dimensions:

15-1/4"W x 24"D x 34"H



Outdoor Stainless Steel Beverage Cooler

Part Number: BBQ10715

Refreshments are just as important as great food. Add this outdoor beverage cooler and never run out of drinks!

Dimensions:

14-3/4"W x 23"D x 32-1/2"H

Cut Out Dimensions:

15-1/4"W x 24"D x 34"H



Anatomy of a BBQ Island

Quality standards are at the core of every Cal Flame outdoor kitchen. From the inside out, the quality construction is undeniable. Each barbecue island begins with a sturdy metal frame constructed from commercial-grade 16-gauge galvanized steel. The island is then dressed in Hardibacker ceramic tile backer board for added durability and moisture resistance. Additionally, your outdoor kitchen is finished in the material of your choice and fitted with the cooking equipment you selected. Best of all, with premium electronic options to choose from, you can build a complete entertainment center outdoors!

COUNTER TOP DESIGN STYLES



Cal Flame offers a wide selection of Natural Stone Tiles and Porcelain Tiles to choose from, ask your authorized Cal Flame Dealer for color samples.

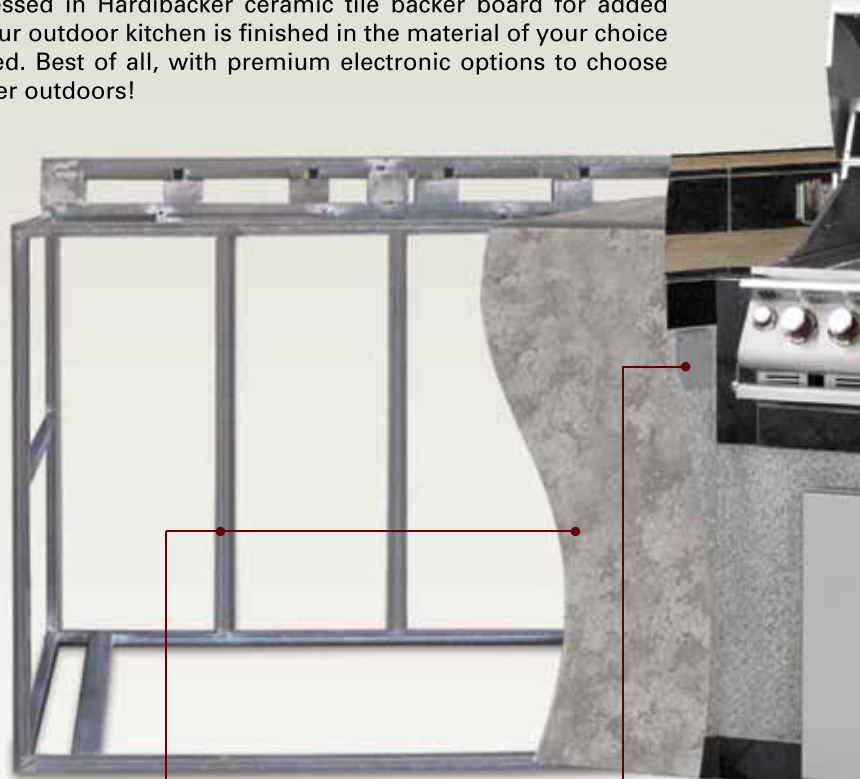

16-GAUGE GALVANIZED STEEL FRAME

For long lasting integrity, the BBQ island frame is manufactured with fully-welded 16-gauge galvanized steel.

HARDIBACKER CERAMIC TILE BACKER BOARD

Moisture-resistance and durability make Hardibacker ceramic tile backer board the perfect base to your create your island's customized finish.

EXTERNAL ELECTRICAL OUTLET

Convenient electric sockets allow you to hook up accessories like blenders, fans and lamps.

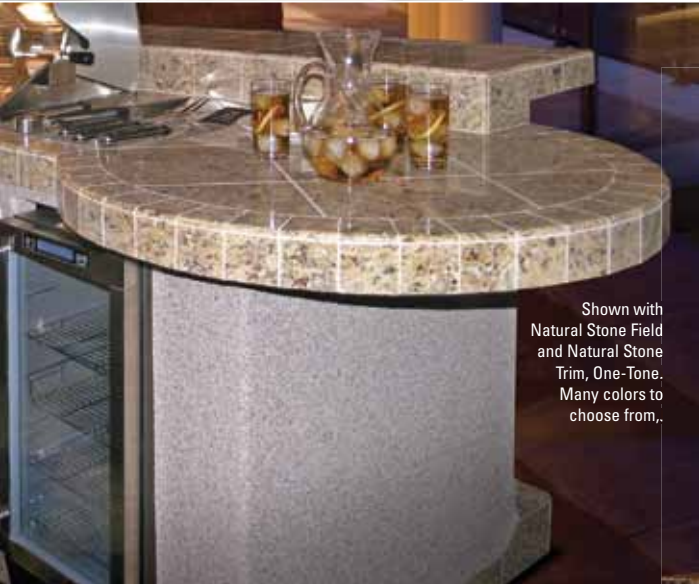

Shown with Natural Stone Field and Natural Stone Trim, One-Tone. Many colors to choose from.



SUPER SPORT BAR CABANA

- Pergola style cabana roof
- Up to three drop down 20" televisions
- Marine stereo system with integrated speakers





COUNTERTOP FINISHES
Finish your countertop with granite, porcelain tile or natural stone tile. Tile options include single and two-tone styles. The choice is yours!



OPTIONAL DROPTOP 20" LCD
Watch your favorite movies or television programs on this integrated flat-panel TV. Nothing goes better with the big game than a barbecue with friends!

LIGHTING
Nighttime dining and entertainment are illuminated by colorful LED lighting in your choice of colors.



BASE FINISHES
Choose from a wide selection of Ameristone Stucco and Cal Stone styles to complement your Home Resort design.

BASE DESIGNS
Outdoor kitchens finished in American Stucco can be accented by assorted tile designs—including trees, geometric patterns and sea life.

STEREO SYSTEMS
Complete the backyard or garden party with an outdoor-grade Sony stereo system blasting your personal mix from marine-grade 6-inch Sony speakers.



PALAPA

- Integrate a 9-foot or 12-foot palapa directly into select islands
- Hand woven palm fronds provide shade while allowing heat to escape
- Natural wood and palm blends well into most backyards

BASE DESIGN STYLES

Add a personalized touch with a tropical or geometric base design:

- Arbor design features palm trees that are recessed in arched arbors
- Tropical design brings home the beauty of paradise with palm trees, a sun and seagulls
- Dolphin design celebrates sea life with a pair of jumping bottlenose dolphins
- Diamond design accentuates the counter top tile choice with subtle diamond accents on the base
- Diamond Textured designs are more intricate and can accentuate up to two tile color choices

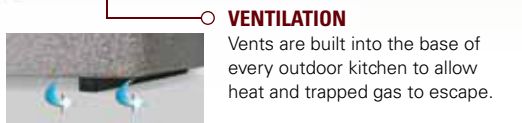

VENTILATION
Vents are built into the base of every outdoor kitchen to allow heat and trapped gas to escape.

SOLID FOOT REST
Footrests provide a convenient relief area during grill-side dining and entertaining.



Arbor



Tropical



Dolphin



Diamond



Diamond Textured



Shown with LED Lighting







BBQ Islands, Grand Pavillion Series

When you have a Grand Pavilion barbecue island in your backyard or garden, you'll want to host every party outdoors. Each unique model is a one-of-a-kind configuration featuring raised bar top seating, split islands or angled returns. For the homeowner that refuses to compromise when it comes to entertaining guests, there is no substitution for the Grand Pavilion. Available Designs 6 unique models.

STEP 1 Choose the configuration fits your backyard or garden.

Grand Pavilion series islands are available in a number of deluxe configurations for any space.

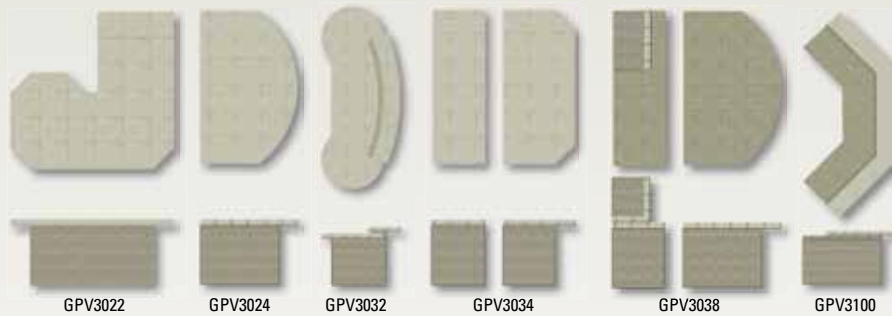

STEP 2 Choose the finish to complement your Home Resort.

Durable American Stucco and elegant natural rock or stone are available in assorted colors and textures to match your Home Resort design. Countertop options include your choice of granite or tile made out of porcelain or natural stone. Tile countertops can be further customized with single or two-tone styles.

Select your main tile & tile trim colors, 18 to choose from!

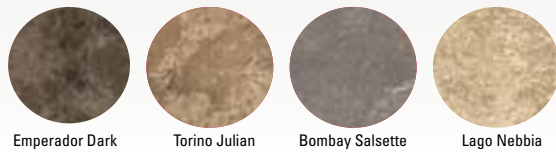

Select from Stucco or Cultured Stone for your BBQ Island base, 14 to choose from!

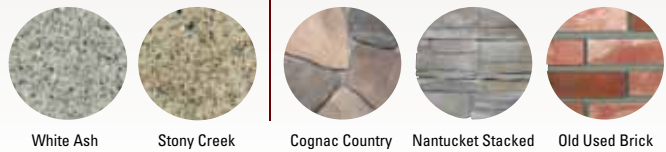

STEP 3 Build your outdoor kitchen.

Cal Flame offers everything a grillmaster could want in stainless steel cooking equipment—including professional grills, double side burners and outdoor refrigerators. Mix and match accessories until you find the combination that suits your gourmet needs. Check out the Grills and Accessories section for options.



STEP 4 Enjoy the best outdoor meals you've ever tasted.

Homeowners with Cal Flame outdoor kitchens have a habit of making relaxation a lifestyle and reconnecting with friends and family over gourmet meals. Now you can join them!



BBQ Islands, Grand Pavillion Series

The perfect blend of uncompromising design and practical function meet here. Your Grand Pavilion island is the centerpiece in your Home Resort.



Grand Pavilion **GPV3024**



Grand Pavilion **GPV3032**



Grand Pavilion **GPV3022**



Grand Pavilion **GPV3100**





Grand Pavilion **GPV3034**



Grand Pavilion **GPV3038**







BBQ Islands, Pavilion Series

Cal Flame Pavilion series islands are available in four different sizes and are designed to accommodate backyards and gardens of any size. Whether your specific needs require more cooking space, seating areas or extra real estate for accessories, Cal Flame offers a Pavilion island to satisfy them. Choosing a Pavilion barbecue has never been so easy.

STEP 1 Choose the configuration fits your backyard or garden.

Pavilion series islands were designed to accommodate any space. Islands are offered in four base widths: **4', 6', 8'** and **10'**. Invite the whole neighborhood over or just a few friends. Cal Flame has the size you need. 22 Styles & Sizes to choose from, visit www.calflamebbq.com to see full line-up.



STEP 2 Choose the finish to complement your Home Resort.

Durable American Stucco and elegant natural rock or stone are available in assorted colors and textures to match your Home Resort design. Countertop options include your choice of granite or tile made out of porcelain or natural stone. Tile countertops can be further customized with single or two-tone styles.

Select your main tile & tile trim colors, 18 to choose from!

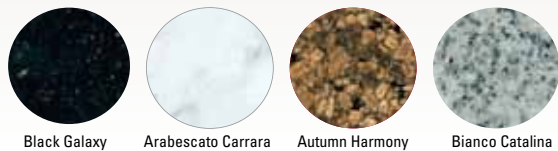

Select from Stucco or Cultured Stone for your BBQ Island base, 14 to choose from!

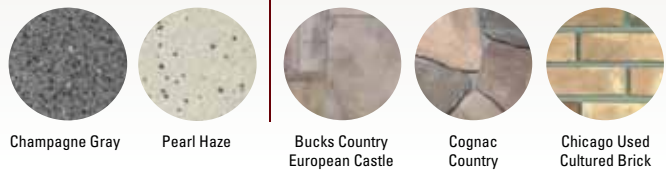

STEP 3 Build your outdoor kitchen.

Cal Flame offers everything a grillmaster could want in stainless steel cooking equipment—including professional grills, double side burners and outdoor refrigerators. Mix and match accessories until you find the combination that suits your gourmet needs. Check out the Grills and Accessories section for options.



STEP 4 Enjoy the best outdoor meals you've ever tasted.

Homeowners with Cal Flame outdoor kitchens have a habit of making relaxation a lifestyle and reconnecting with friends and family over gourmet meals. Now you can join them!



BBQ Islands, Pavilion Series

Build the ultimate custom outdoor kitchen. You pick the size, shape, design and equipment that meets your needs and satisfies your desires. Available Designs: 4' Base Designs: 6' Base Designs: 8' Base Designs: 10' Base Designs.



Pavilion **PV4010**



Pavilion **PV4036**



Pavilion **PV6006**



Pavilion **PV6014**



Pavilion **PV6034**



Pavilion **PV6016**





Pavilion 6' **PV6004** or 8' **PV8004**



Pavilion **PV6020**



Pavilion **PV6026**



Pavilion **PV6027**



Pavilion **PV6032**



Pavilion 8' **PV8012** or 10' **PV1012**



Pavilion **PV8030**







LBK Islands, Outdoor Kitchens

Turn your backyard into a state-of-the-art outdoor kitchen with the Cal Flame LBK BBQ Island Series! This breathtaking barbecue island series allows you to choose the size and color options that best fit your lifestyle and backyard landscape. Whether you are looking for a BBQ Island for entertaining family and friends or cooking simple backyard meals, the LBK BBQ Island Series has the island that is perfect for you and your home.

The LBK BBQ Island Series features the following stainless steel cooking equipment:

- G-Series 4-Burner Grill
- Stainless Steel Refrigerator (select models)
- Stainless Steel Single or Double Access Door
- Standard Single Flat Side Burner (select models)

STEP 1 Choose the configuration fits your backyard or garden.

The LBK BBQ Islands were designed to accommodate any backyard space. These eye-catching islands are available in four base widths: 4', 6', or 8'.

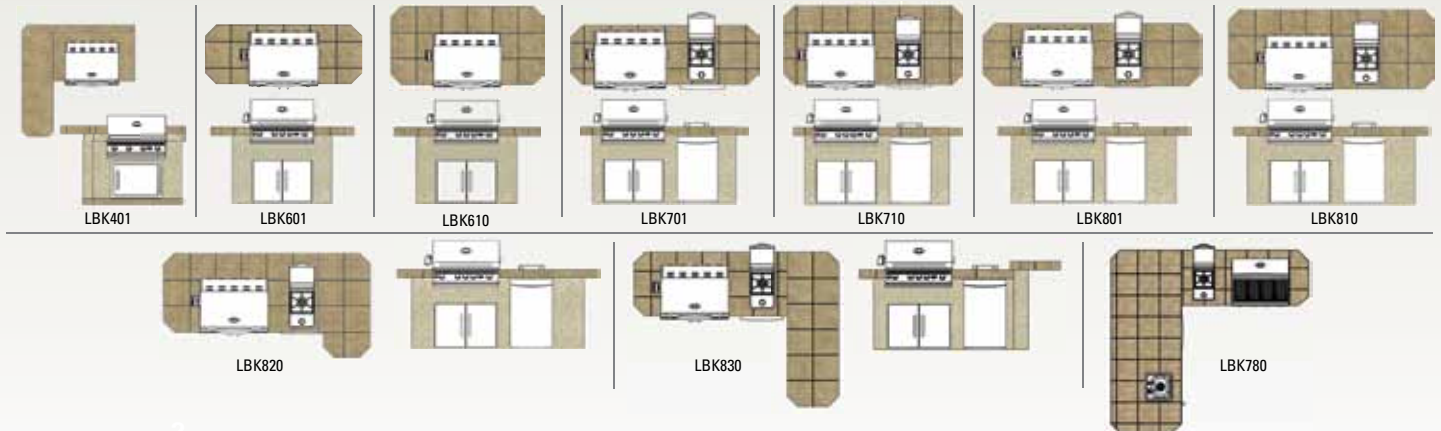

STEP 2 Choose the finish to complement your Home Resort.

Durable American Stucco and elegant natural rock or stone are available in assorted colors and textures to match your Home Resort design. Countertop options include your choice of granite or tile made out of porcelain or natural stone. Tile countertops can be further customized with single or two-tone styles.

Select your main tile & tile trim colors, 18 to choose from!

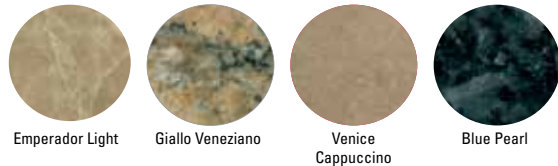

Select from Stucco or Cultured Stone for your BBQ Island base, 14 to choose from!



STEP 3 Enjoy the best outdoor meals you've ever tasted.

Homeowners with Cal Flame outdoor kitchens have a habit of making relaxation a lifestyle and reconnecting with friends and family over gourmet meals. Now you can join them!



LBK BBQ Islands

Build the outdoor kitchen of your dreams with Cal Flame! Choose the size and color options that meet your needs and complement your lifestyle. Available Designs: 4' Base Designs, 6' Base Designs, and 8' Base Designs.



LBK 401



LBK 801



LBK 601



LBK 701



LBK 610





LBK 710



LBK 780



LBK 810



LBK 820



LBK 830



BBQ Islands, Knock Down Series

These breathtaking 6-foot barbecue islands feature a unique “knock down” design for easy assembly. Best of all, the KD BBQ Islands can be customized with the grill, accessories, counter top and base design of your choice!





KD6002 (Shown with the Cabana)

Complete your backyard Home Resort with the cutting-edge **KD6002 BBQ Island**. This “knock down” custom barbecue island has been designed to satisfy both the prefab and customized barbecue island markets by offering a prefab barbecue island that you can customize with the grill, accessories, counter top and base design that best fits your lifestyle, backyard landscape and budget. The **KD BBQ Island** comes in five pieces, which are easily assembled. Shown with the optional Cabana.

CABANA (Size Shown: 104” x 111”. Also available in: Size: 135” x 109”)

The Arch Series cabana is a stylish way to complete your outdoor kitchen and provide shade during warm seasons. This wooden arch adds an elegant touch to any Cal Flame BBQ Island. It fits perfectly over the island and comes with two (2) wooden posts that secure tightly to the island and/or ground. The Arch is available with 8-foot or 12-foot roof styles.

KD6016 (Shown on Left Page)

The cutting-edge KD 6016 BBQ Island Series is an innovative 6-foot barbecue island that has a counter bar top. Customized with the grill and accessories of your choice. The KD BBQ Islands feature a “knock down” design and come in five (5) pieces (panels), which are easily assembled.

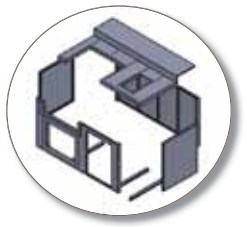
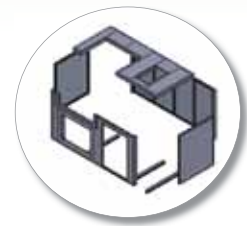



Anatomy of a Fireplace

Cal Flame outdoor fireplaces add a sense of enchantment, magic and nostalgia to any backyard or garden. Homeowners will enjoy the beauty and dynamics that a fireplace brings to their Home Resort while guests will appreciate the year-round nighttime entertainment. Every Cal Flame fireplace is constructed to the highest standard, utilizing a 16-gauge galvanized steel frame and reinforced by Hardibacker tile backer board. Your fire fixture will be a source of elegance and entertainment for years to come.

EXTENDED CHIMNEY

Cal Flame fireplaces with the wood burning option will be constructed with an additional 18" high chimney.

LIQUID PROPANE AND NATURAL GAS CONVERTIBLE

For your convenience, Cal Flame fireplaces can take advantage of your choice of fuel.

SIMULATED STONE ARCH

Add a touch of distinction with a simulated stone arch. Available on 906, 907, 908, 909, 910, 914 and 915.

FIREBOX 36-INCH ARCH DESIGN

Metal with fiberglass panels and straight firebox. Available on all fireplaces except FRP-905.

MANTLE

Decorate your fireplace with your favorite knick-knacks or plants. Available in Natural Stone Tile, Porcelain Tile or Bedrock® Panel.

WRAPPED BOTTOM MANTLE

This mantle wraps around the front and sides of the fireplace creating more room for personal decorations. Available in Natural Stone Tile, Porcelain Tile or Bedrock® Panel.

ON/OFF SWITCH

Every fireplace switch utilizes a Piezo ignition system, which is a battery-powered electronic ignition.

EXTENDED BOTTOM MANTLE

Accent the base of your fireplace with a sophisticated extended base in front of the firebox. Available in Natural Stone Tile, Porcelain Tile or Bedrock® Panel.

STAINLESS STEEL BURNER

Light up the night and drive away the cold with a powerful 55,000 BTUs of heat.

GRATE

All Cal Flame fireplaces benefit from this 18-inch grate which supports either standard fire logs or real logs.

LAVA ROCKS

As a standard feature on all natural gas or liquid propane fireplaces, Lava rocks accent the base of the firebox.

FIRE LOGS

Decorative logs come standard with 36-inch fireboxes. Log sizes are measured by the front largest log in the set:
• 36-Inch Firebox: 7 logs, 24-inch.



Fireplace Series

Cal Flame outdoor fireplaces are the perfect way to extend the outdoor season and seek warmth in the great outdoors. The innovative Cal Flame outdoor fireplaces feature all the latest technology and allow you to enjoy cool evenings.



A Cal Flame outdoor fireplace instantly adds a warm glow to your outdoor home resort, creating a calm, inviting ambiance. Cal Flame outdoor fireplaces can be customized to fit your personal taste and complement any backyard landscape. Designed with the finest material and craftsmanship, Cal Flame outdoor fireplaces are built to withstand all outdoor elements for years of enjoyment. Cal Flame outdoor fireplaces feature a 304-commercial grade stainless steel frame, sturdy one-piece construction, ETL approval and have a liquid propane/natural gas option. Enjoy the warmth of Cal Flame today!



FRP-906

BURNER BTU OUTPUT: 55,000
DIMENSIONS* WITH 36" FIRE BOX: 48" W X 28" D X 59" H
SHOWN: STANDARD, ONE STYLE, COLOR & SHAPE.



FRP-905

BURNER BTU OUTPUT: 55,000

DIMENSIONS* WITH 24" FIRE BOX: 39" W X 24" D X 67" H

SHOWN: STANDARD, ONE STYLE, 4 PIECE, 16" LOG SET WITH LAVA ROCKS



FRP-908

BURNER BTU OUTPUT: 55,000

DIMENSIONS* WITH 36" FIRE BOX: 72" W X 38" D X 78" H

SHOWN WITH: WRAPPED MANTEL

Customize with your choice of Ameristone Stucco in 5 different Colors.





36" FIREBOX

FRP-908 As Shown:

Bedrock® Panel Top Mantel, Bedrock® Panel Rounded Arch 36", No Bottom Mantel



**STANDARD WITH FIREPLACES:
7 PIECE 24" FIRE LOGS**



36" FIREBOX

FRP-908 As Shown:

Tiled Top Mantel, Bedrock® Panel Rounded Arch 36" Extended Bottom Mantel*

***NOTE: THE EXTENDED BOTTOM MANTEL ADDS APPROXIMATELY 12" IN DEPTH**



36" FIREBOX

As FRP-908 As Shown:

Tiled Top Mantel, Bedrock® Panel Rounded Arch 36" Wrapped Bottom Mantel**

****NOTE: THE WRAPPED BOTTOM MANTEL ADDS APPROXIMATELY 12" IN DEPTH AND 24" IN WIDTH**



FRP-910

BURNER BTU OUTPUT: 55,000
DIMENSIONS* WITH 36" FIRE BOX: 48"W X 38"D X 78"H
SHOWN WITH: EXTENDED MANTEL

Customize with your choice of Ameristone Stucco in 5 different Colors, or 8 beautiful Cultured Stone styles. Accent Trim with Porcelain Tile or Natural Stone Tile.



FRP-909

BURNER BTU OUTPUT: 55,000
DIMENSIONS* WITH 36" FIRE BOX: 72"W X 38"D X 78"H
SHOWN WITH: WRAPPED MANTEL

Customize with your choice of Ameristone Stucco in 5 different Colors, or 8 beautiful Cultured Stone styles. Accent Trim with Porcelain Tile or Natural Stone Tile.



FRP-915

BURNER BTU OUTPUT: 55,000
DIMENSIONS* WITH 36" FIRE BOX: 78"W X 28"D X 78"H
SHOWN WITH: STANDARD, ONE STYLE SHAPE

Customize with your choice of Ameristone Stucco in 5 different Colors.







Anatomy of a Firepit

Whether it's a campfire in the woods, a bonfire at the beach or a firepit in the privacy of an outdoor Home Resort, people have enjoyed the relaxing and meditative properties of an open fire. Cal Flame captures that magic of fire in every firepit, which is constructed with 16-gauge galvanized steel and Hardibacker tile backer board for support and moisture resistance. Cal Flame firepits offer lasting and vibrant nighttime entertainment that can't be beat.

STAINLESS STEEL BURNER

The powerful burner emits 55,000 BTUs and will easily keep everyone around the firepit comfortable on a chilly night.

FIRE LOGS AND LAVA ROCKS

All Cal Flame firepits come equipped with a 4-piece fire log set as well as lava rocks or give your fire rustic naturalness.

TABLETOP FIRE

For the ultimate in outdoor entertainment and relaxation, tabletop firepits can accommodate up to six guests. The innovative FPT-G5000 features a two-piece glass top and elegant footrest that will add lasting beauty and variety to your Home Resort.

SHAPES

Firepits come in round, square, hexagonal (6-sided) and octagonal (8-sided) shapes to accommodate any backyard preference.



LIQUID PROPANE OR NATURAL GAS CONVERTIBLE

Use liquid propane tanks or have a natural gas line professionally installed.

HEIGHT

Firepits are available from 18" in height to replicate the campfire experience to 36" in height to create a conversational area that will accommodate full-height barstools. The choice is yours!

ON/OFF SWITCH

Every fireplace switch utilizes a Piezo ignition system, which is a battery-powered electronic ignition.



Firepit Series

Fire has always attracted people with its natural ability to warm, comfort and entertain. It is nothing short of magical. Cal Flame shares that magic with you and your family by offering the finest in outdoor fire fixtures.

How many stories will you swap with friends around an open fire on a cold winter night? How many romantic evenings by the fire will you share with someone? How often will you find yourself lost in thought while a fire dances before your eyes? Capture the magic of fire today. Make every moment count with Cal Flame. ETL approval and have a liquid propane/natural gas option. Enjoy the warmth of Cal Flame today!



FPT-S7000 RAYS OF LIGHT *CUSTOMIZE WITH LED OPTION
DIMENSIONS: 69"R X 32"H
STANDARD FEATURES: TEMPERED GLASS TABLE TOP, STAINLESS STEEL BASE, 3 CYLINDERS, WHICH CAN BE FILLED WITH STERNO CANNED HEAT OR THE CANDLES OF YOUR CHOICE.



FPT-5000 *CUSTOMIZE WITH LED OPTION
BURNER BTU OUTPUT: 55,000
DIMENSIONS: 69"R X 45"H
STANDARD FEATURES: TEMPERED GLASS TABLE TOP, AMERISTONE STUCCO, 4 PIECE LOG SET W/ LAVA ROCKS, LP/NG CONVERTIBLE



FPT-R1050 *CUSTOMIZE TO YOUR DECOR, SEE DETAILS ABOVE
BURNER BTU OUTPUT: 55,000
DIMENSIONS: 60"R X 45"H
STANDARD FEATURES: AMERISTONE STUCCO, PORCELAIN TILE, 4 PIECE LOG SET W/ LAVA ROCKS, LP/NG CONVERTIBLE



FPT-2500 *CUSTOMIZE WITH LED OPTION
BURNER BTU OUTPUT: 55,000
DIMENSIONS: 69"R X 32"H
STANDARD FEATURES: TEMPERED GLASS TABLE TOP, AMERISTONE STUCCO, 4 PIECE LOG SET W/ LAVA ROCKS, LP/NG CONVERTIBLE





*Customize with your choice of Ameristone Stucco in 5 different Colors. 8 beautiful Cultured Stone styles to choose from. Accent Trim with Porcelain Tile or Natural Stone Tile. Also available on selected models: LED Lighting, multi-setting light show or simply program to your favorite single color.



FPT-S301

BURNER BTU OUTPUT:
DIMENSIONS:
STANDARD FEATURES:

55,000
48"W X 48"D X 20"H
AMERISTONE STUCCO, PORCELAIN TILE,
4 PIECE LOG SET W/ LAVA ROCKS, LP/NG CONVERTIBLE

*CUSTOMIZE TO YOUR DECOR, SEE DETAILS ABOVE



FPT-S302

BURNER BTU OUTPUT:
DIMENSIONS* WITH 36" FIRE BOX:
STANDARD FEATURES:

55,000
48"W X 48"D X 35"H
AMERISTONE STUCCO, PORCELAIN TILE,
4 PIECE LOG SET W/ LAVA ROCKS, LP/NG CONVERTIBLE

*CUSTOMIZE TO YOUR DECOR, SEE DETAILS ABOVE



FPT-H401

BURNER BTU OUTPUT:
DIMENSIONS:
STANDARD FEATURES:

55,000
49-1/2"W X 49-1/2"D X 20"H
AMERISTONE STUCCO, PORCELAIN TILE,
4 PIECE LOG SET W/ LAVA ROCKS, LP/NG CONVERTIBLE

*CUSTOMIZE TO YOUR DECOR, SEE DETAILS ABOVE



FPT-H402

BURNER BTU OUTPUT:
DIMENSIONS* WITH 36" FIRE BOX:
SHOWN WITH:

55,000
49-1/2"W X 49-1/2"D X 35"H
AMERISTONE STUCCO, PORCELAIN TILE,
4 PIECE LOG SET W/ LAVA ROCKS, LP/NG CONVERTIBLE

*CUSTOMIZE TO YOUR DECOR, SEE DETAILS



Cal Flame®

THE HOME RESORT EXPERIENCE

Visit your Cal Flame dealer today and transform your home into a Cal Flame Home Resort with the world's largest and most complete selection of stylish outdoor living products that inspire the imagination, add value to your home and enhance your lifestyle.



Your Authorized Cal Flame Dealer:



1462 East Ninth Street, Pomona, CA 91766
800-CAL-SPAS | WWW.CALFLAMEBBQ.COM



©2013 Cal Flame, a division of LMS, Inc. All rights reserved. Cal Flame, Cal Spas, Cal Designs, and Cal Heat are trademarks of LMS, Inc. All other brands, product names, company names, trade names, trademarks and service marks are the property of their respective owners, and are used with permission. Cal Flame reserves the right to enhance, modify or discontinue products at any time without notice. Specifications may change without notice. Dimensions are approximate. Products are manufactured under US patent. Patent numbers are available. Photographs and graphics are for illustration purposes only and may differ from actual product.

2039-12
Rev. 1 6.05.13
LTR2013BBQ-BR

